

A	B	C (mm)		D
1	S387-0005	440	433	3/3
2	S387-0006	440	433	3/3
3	S387-0007	908	433	3/3
4	S387-1006	1382	450	1/3
5	S387-1007	1382	450	1/3
6	S387-1008	1382	450	2/3
7	S387-2005	944	451	2/3
8	S387-2006	944	451	2/3
9	S387-3006	437	424	2/3
10	S387-3007	437	412	3/3
11	S387-3008	438	429	3/3
12	S387-3012	438	429	3/3
13	S387-9004	1392	448	1/3
14	S387-9005	1392	448	1/3

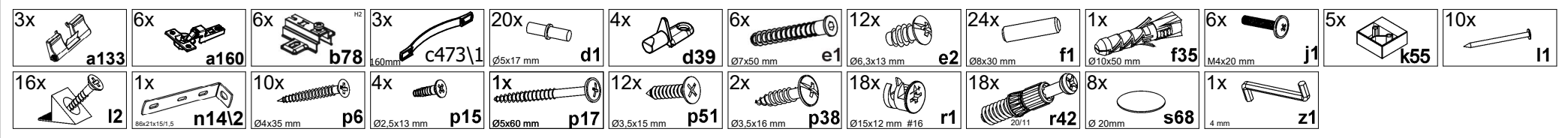

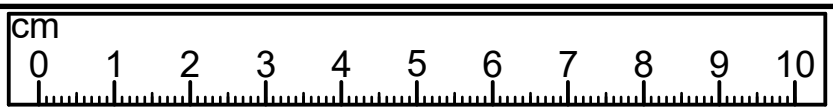

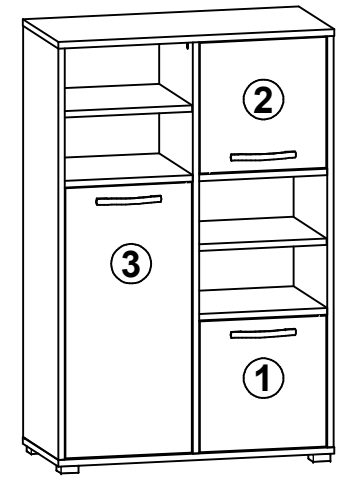
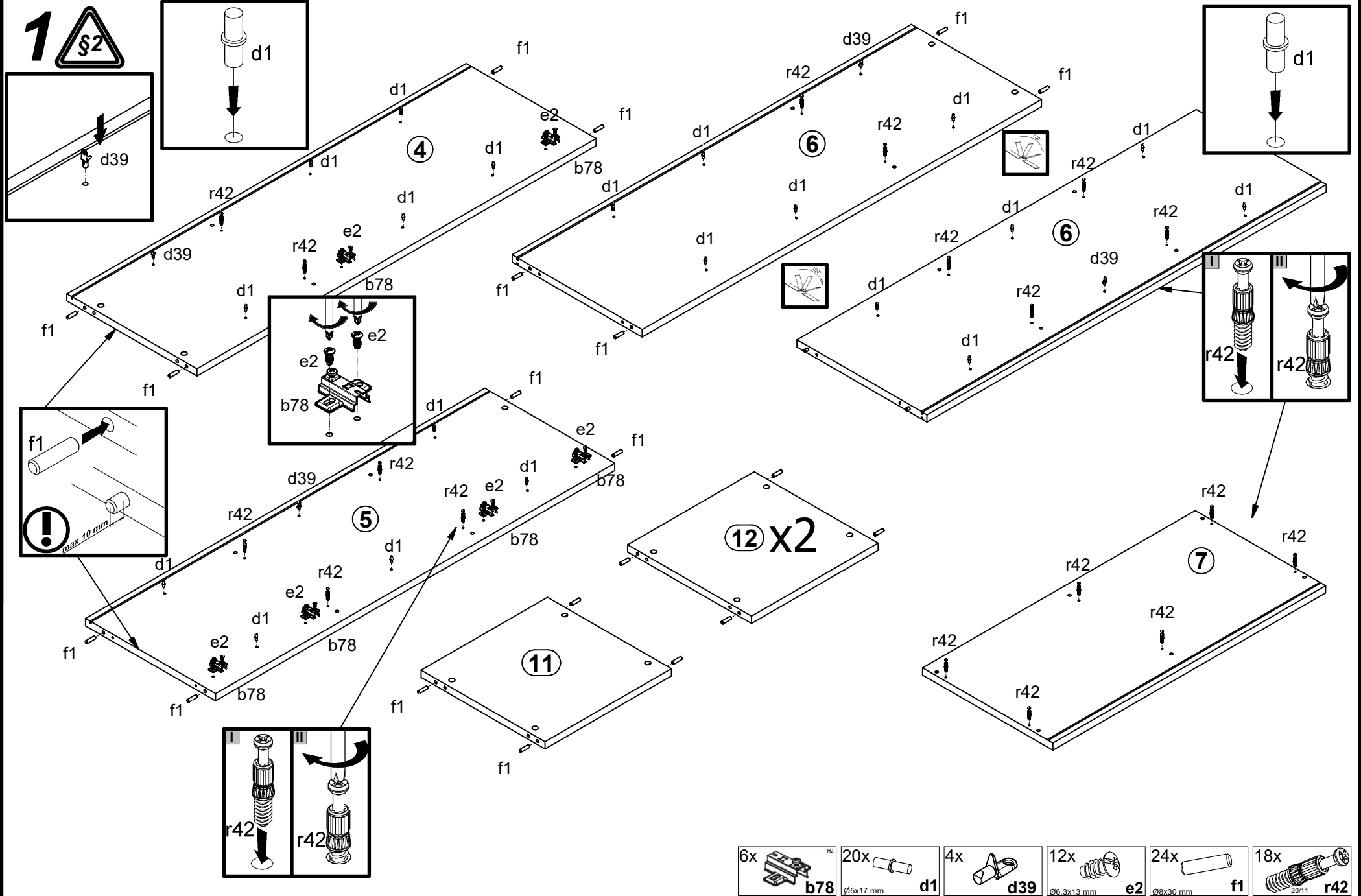
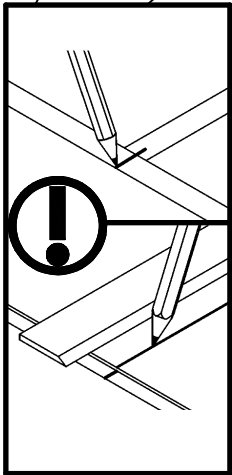
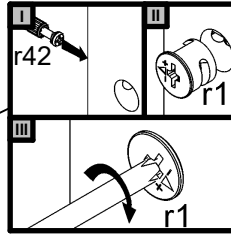
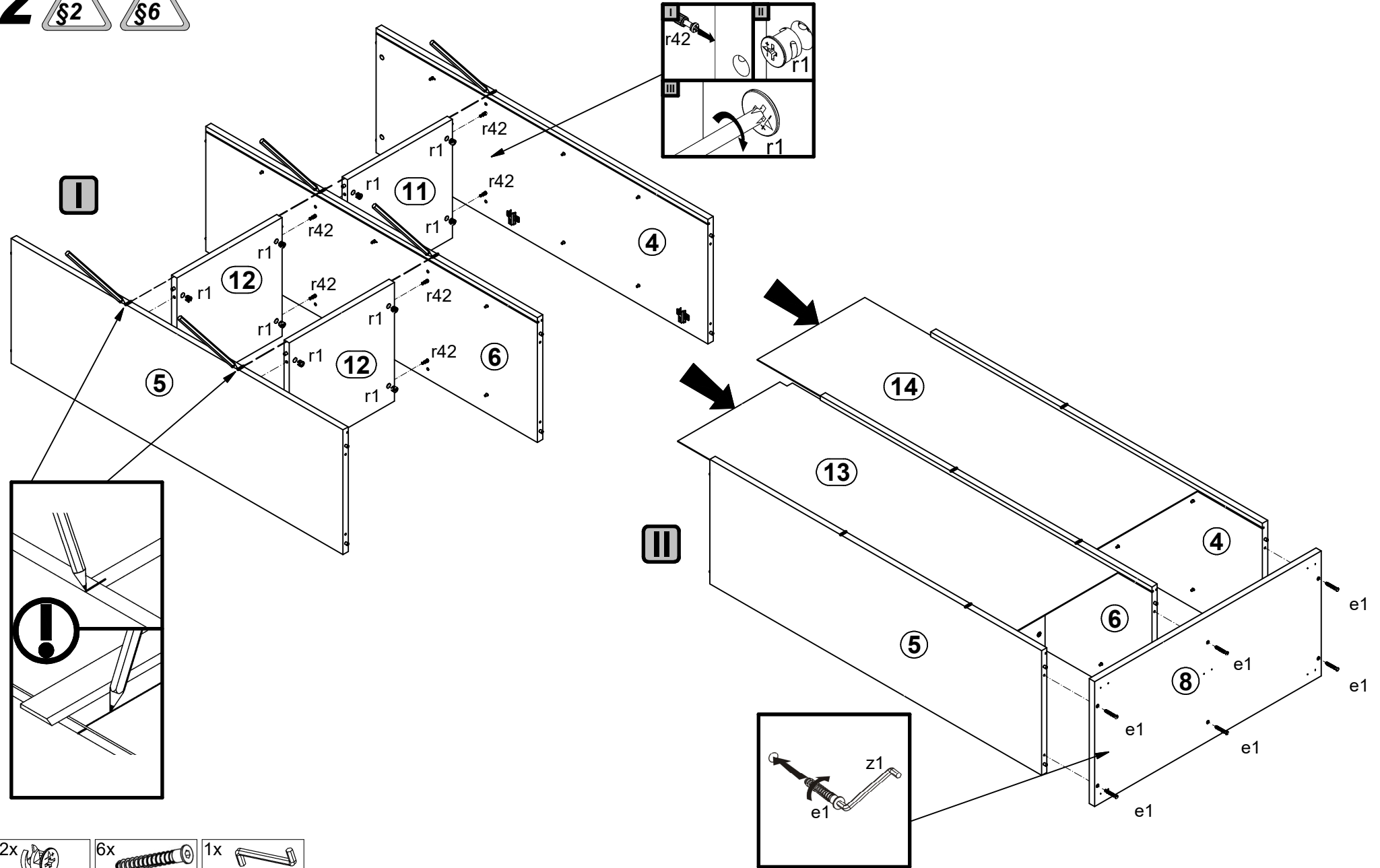

2  

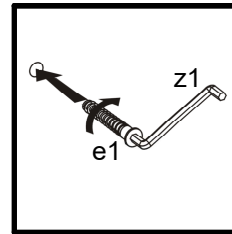

III



- 12x  r1
Ø15x12 mm #16
- 6x  e1
Ø7x50 mm
- 1x  z1
4 mm

3 §2 §6

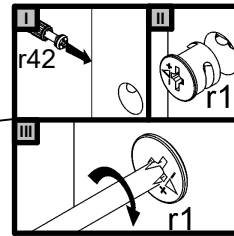
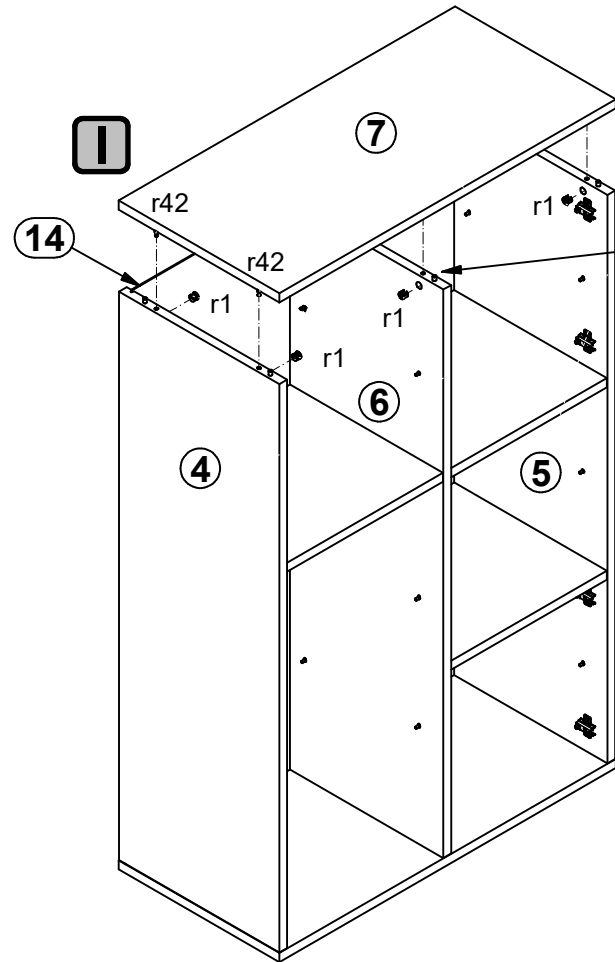
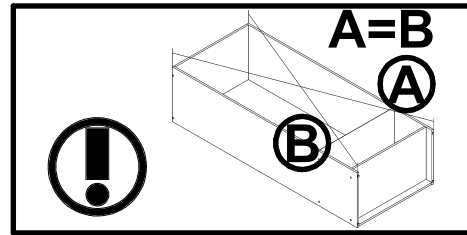

II

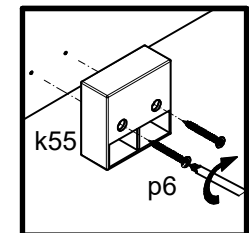
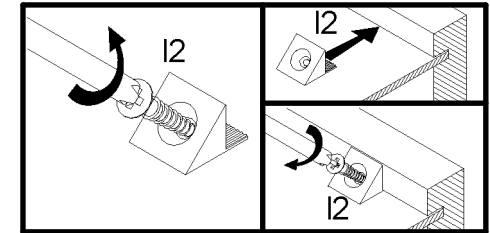
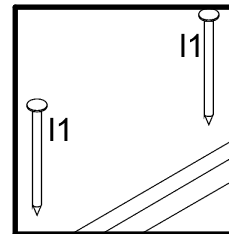
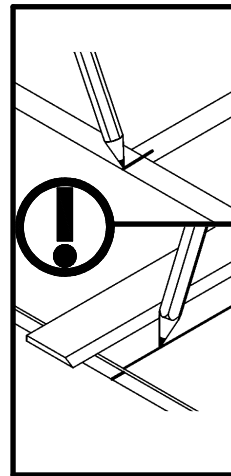
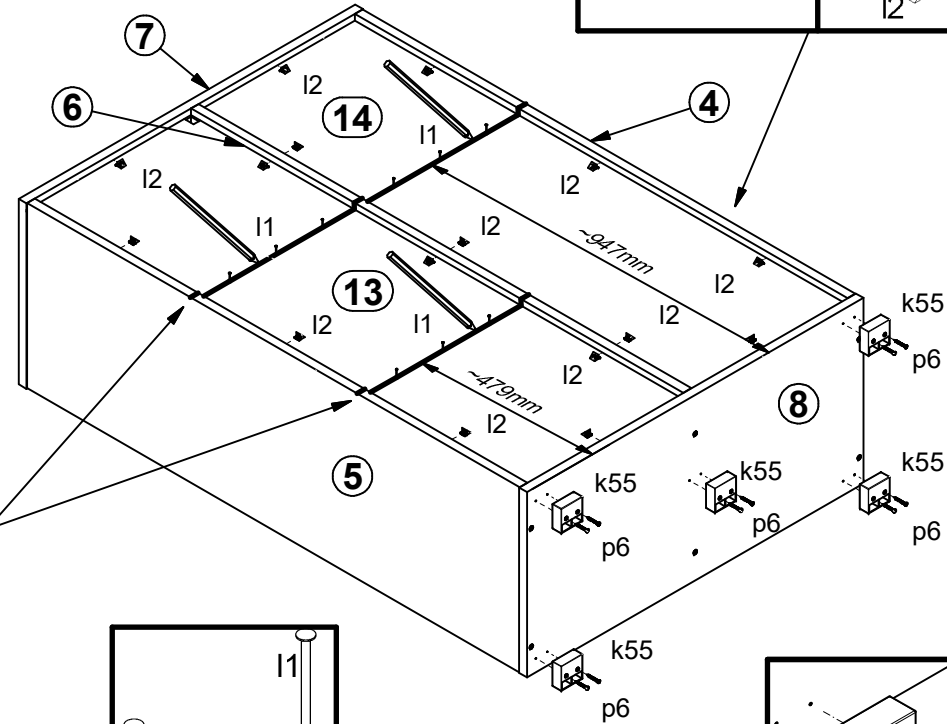

- 10x I1
- 16x I2
- 5x k55
- 10x p6
- 6x r1

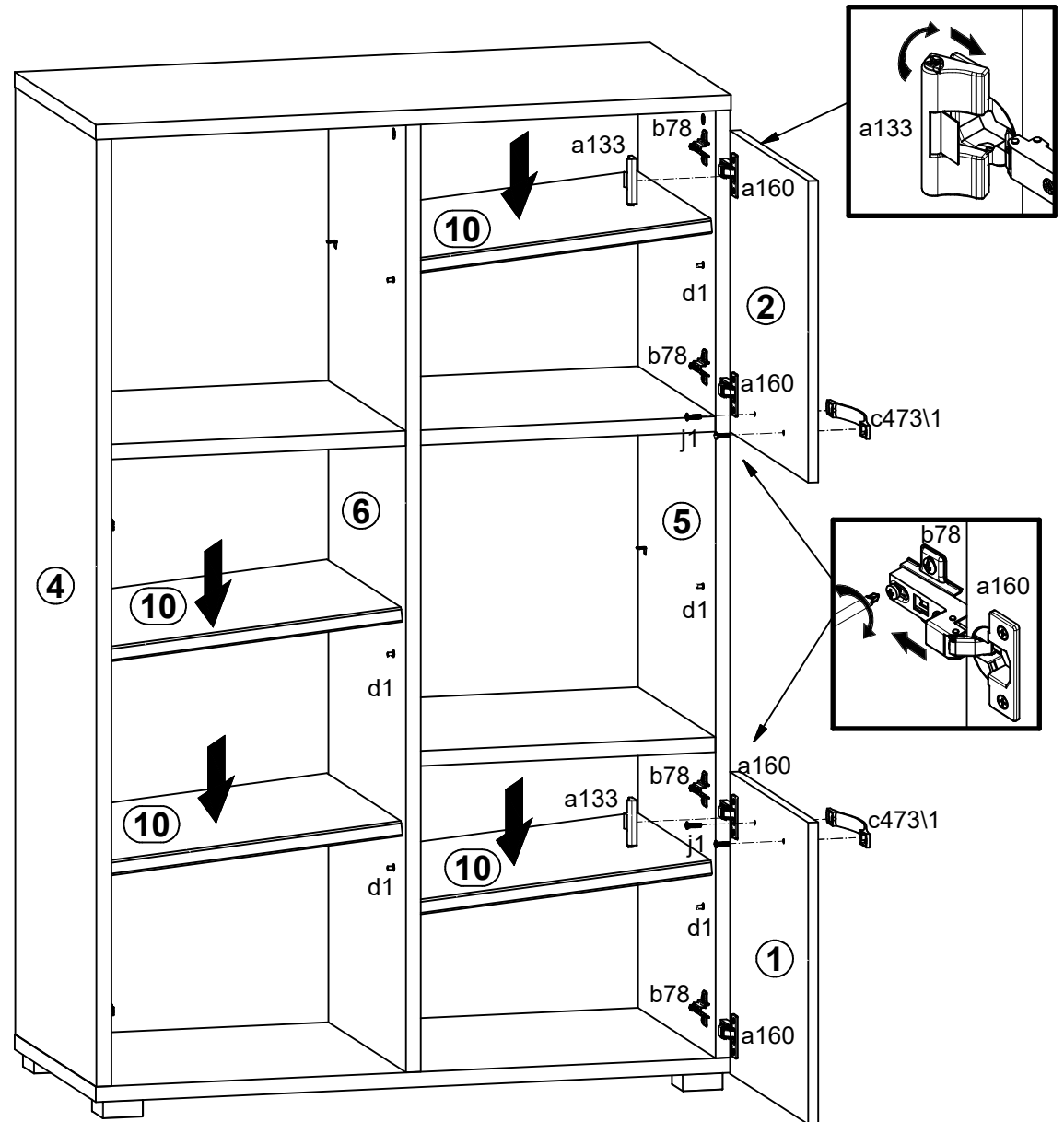
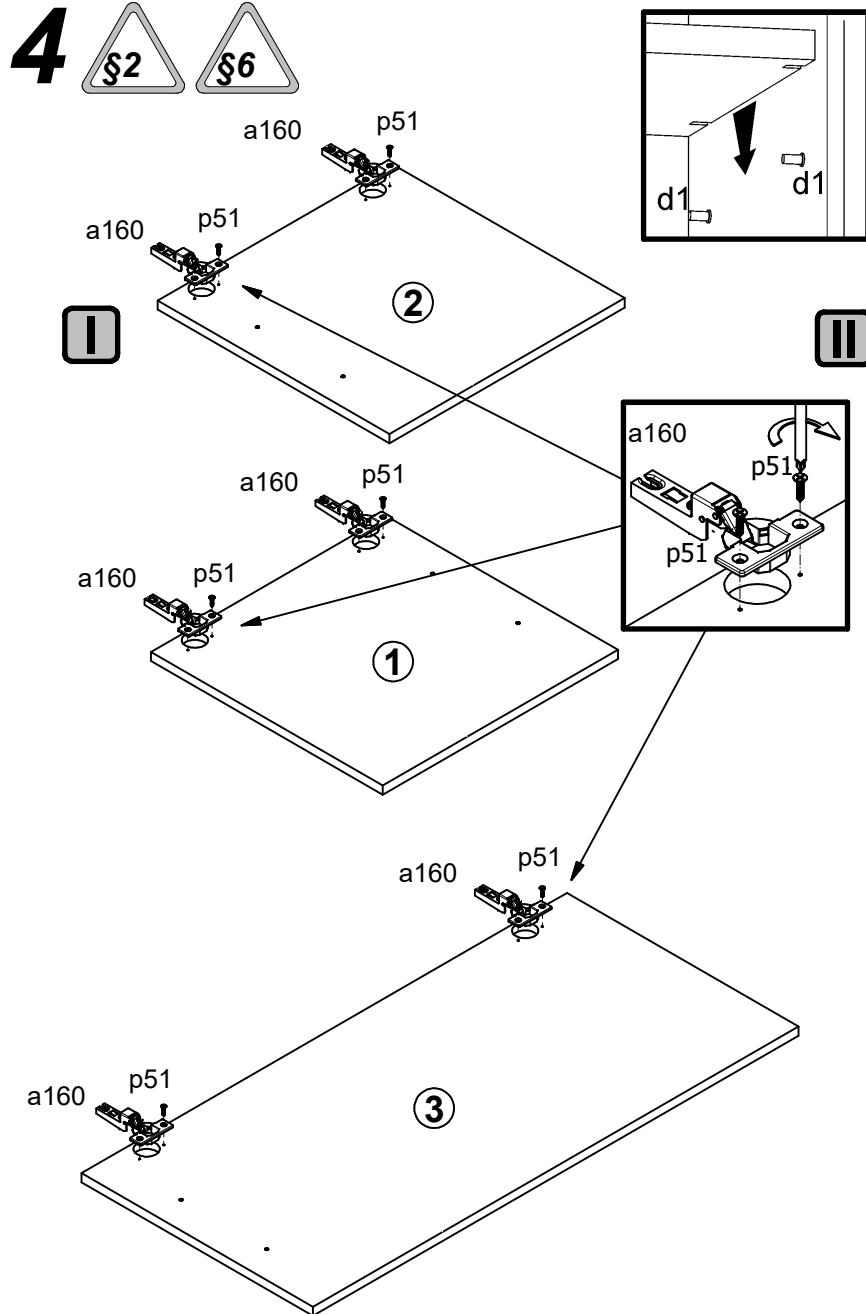

- 2x  **a133**
- 6x  **a160**
- 2x  **c473\1**
- 4x  **j1**
- 12x  **p51**

10

