



44 Avenue Paul Girard
10500 DIENVILLE
FRANCE
www.sciae.com

INSTA

INDICE A - 24/03/2022

INSTA 3633 VITRINE 1PO 1PG N°20 Réf: 22SA3720

EAN: 3102000112589

NOTICE DE MONTAGE
ASSEMBLING INSTRUCTIONS
MONTAGEANLEIUNG
MANUAL DE MONTAJE
MONTAGEVOORSCHRIFT
INSTRUÇÕES DE MONTAGEM
ISTRUZIONI DI MONTAGGIO
ИНСТРУКЦИЯ ПО СБОРКЕ
Naputci za montažu

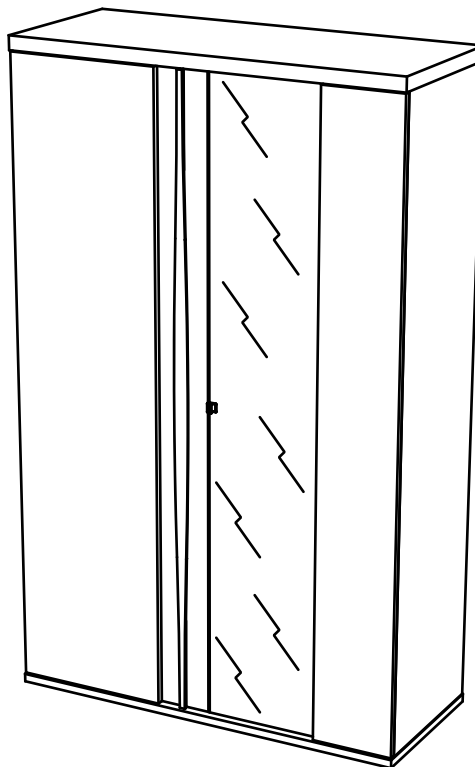

1H30

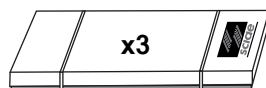

Package 1: 30.5 Kg
Package 2: 29 Kg
Package 3: 33 Kg

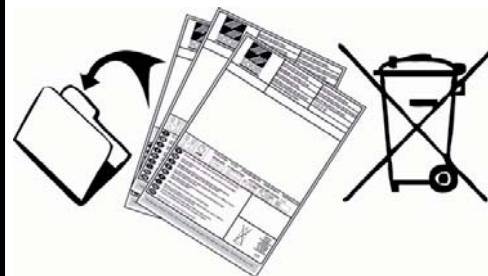

F POUR L'APRES-VENTE, RETOURNEZ AU MAGASIN AVEC CETTE NOTICE

GB FOR THE AFTER SALES, GO BACK TO THE SHOP WITH THIS ASSEMBLY INSTRUCTION

D WENDEN SIE SICH BITTE AN IHREN HANDLER UND GEBEN SIE IHM DIE KENNUMMER DES MOBELS UND DIE TEILNUMMER

E EN CASO DE SERVICIO POST-VENTA DEBEN DE VOLVER A LA TIENDA CON LAS INSTRUCCIONES DE MONTAJE

NL VOOR SERVICE NA VERKOOP, GA NAAR UW LEVERANCIER MET DEZE MONTAGE HANDLEIDING

P PARA O POS VENDA, VOLTE A LOJA COM ESTA FOLHA

I SERVIZIO POST VENDITA: E NECESSARIO PRESENTARSI SUL PUNTO VENDITA CON QUESTE ISTRUZIONI DI MONTAGGIO

RU ДЛЯ ПОСЛЕПРОДАЖНОГО ОБСЛУЖИВАНИЯ ПРОСЬБА ОБРАТИТЬСЯ В МАГАЗИН ПРЕДЪЯВИВ НАСТОЯЩУЮ ИНСТРУКЦИЮ ПО СБОРКЕ

HR U SLUČAJU REKLAMACIJE, VRATITE SE NA PRODAJNO MJESTO S OVIM UPUTAMA ZA MONTAŽU

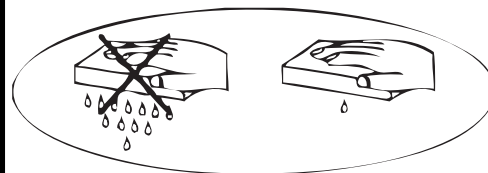

SCIAE se réserve le droit de modifier sans préavis tout ou partie de ses collections - Meuble vendu sans accessoire

	+40°C +104°F	
	+15°C +59°F	
HYGROMETRIE HYGROMETRY 40%-65%		

	1 an 1 year	

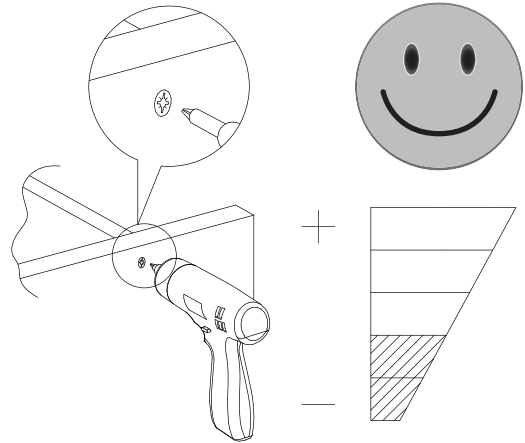
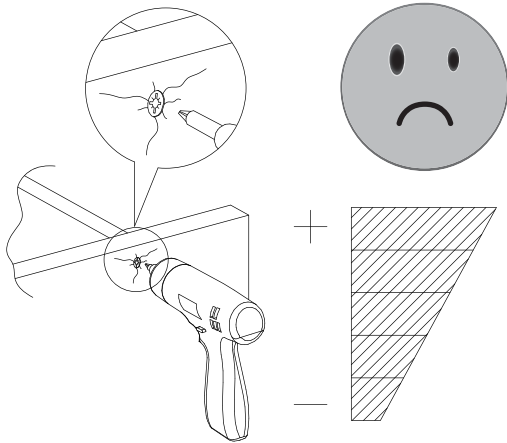
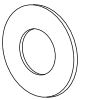
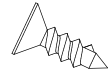
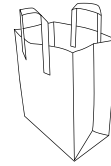
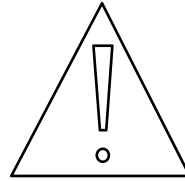

2

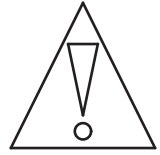
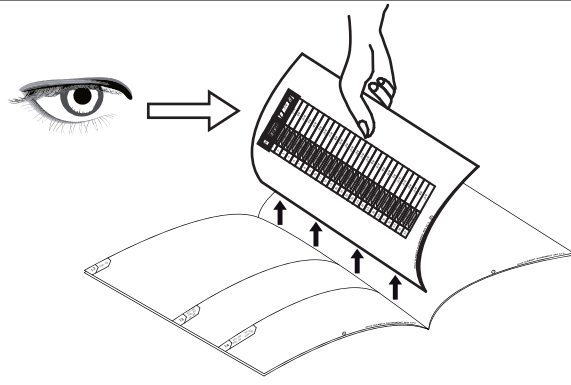

1

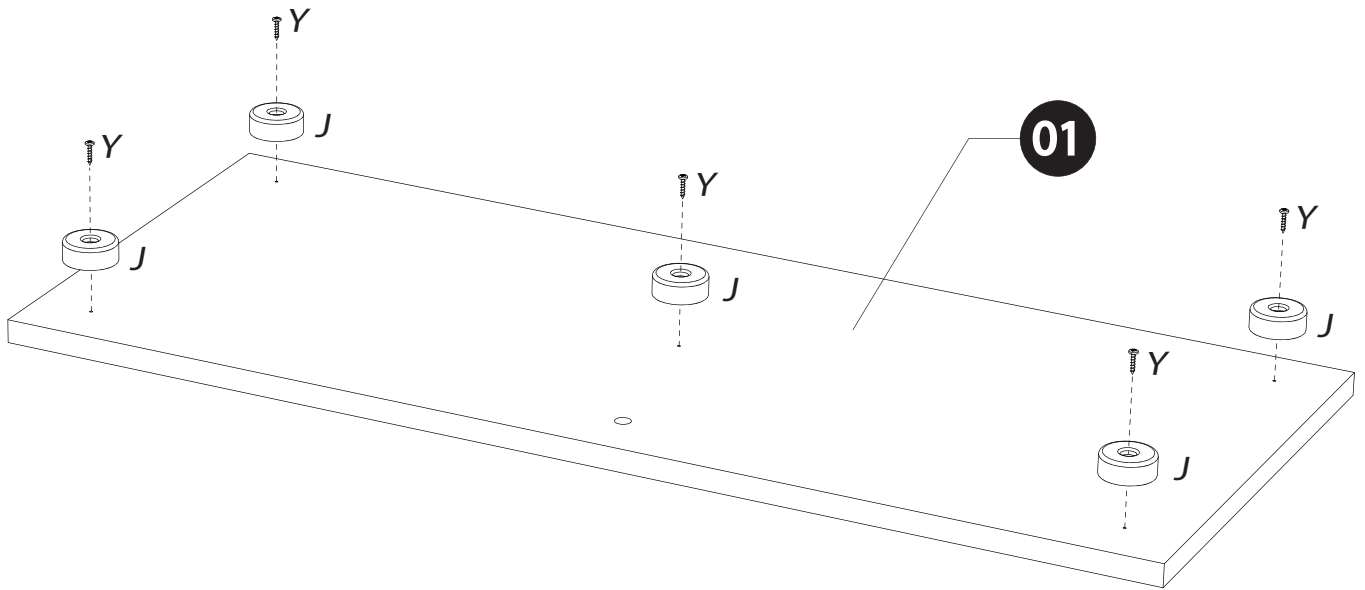
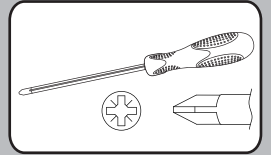
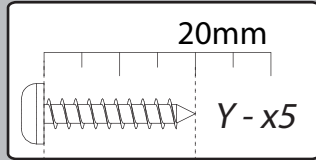
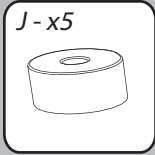

2

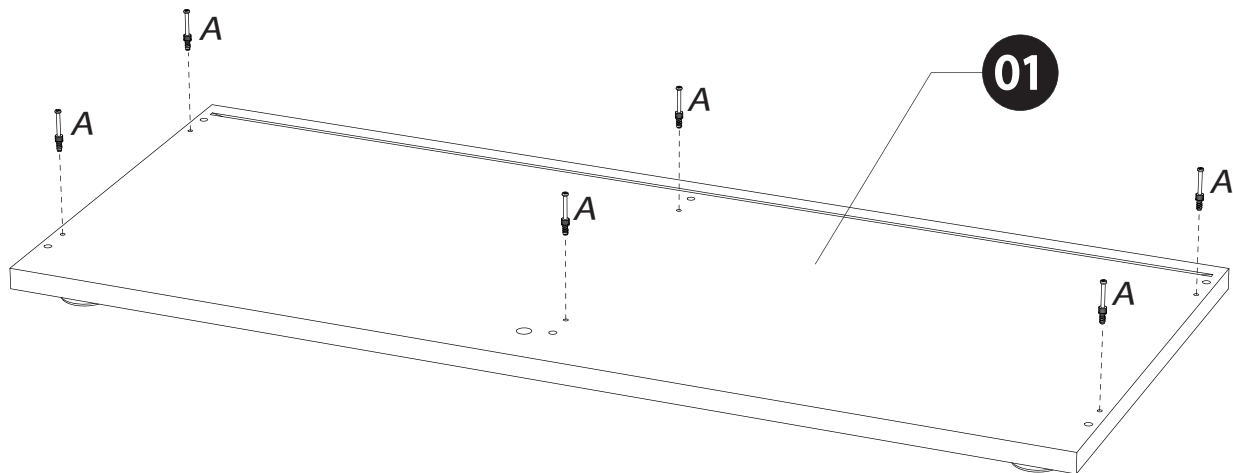
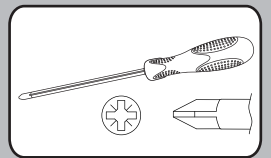
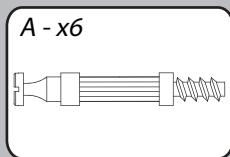

3

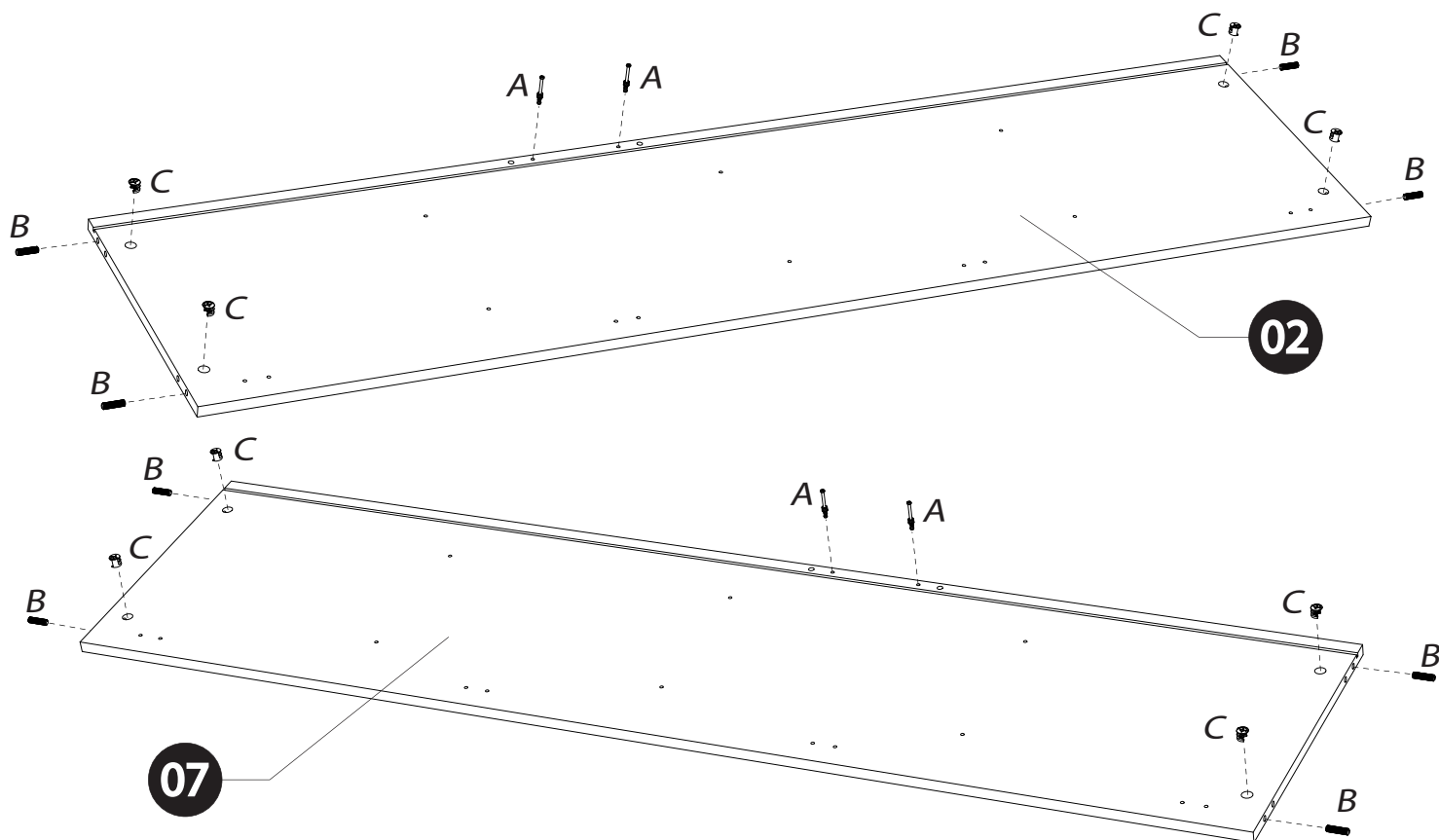
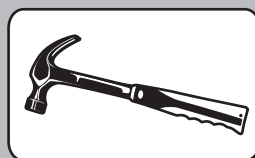
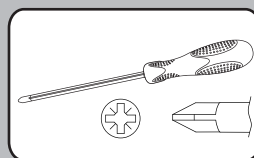
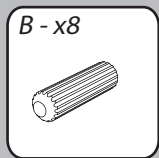
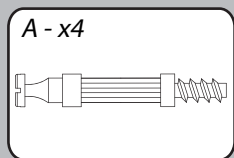
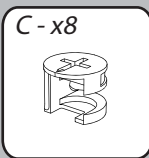

4

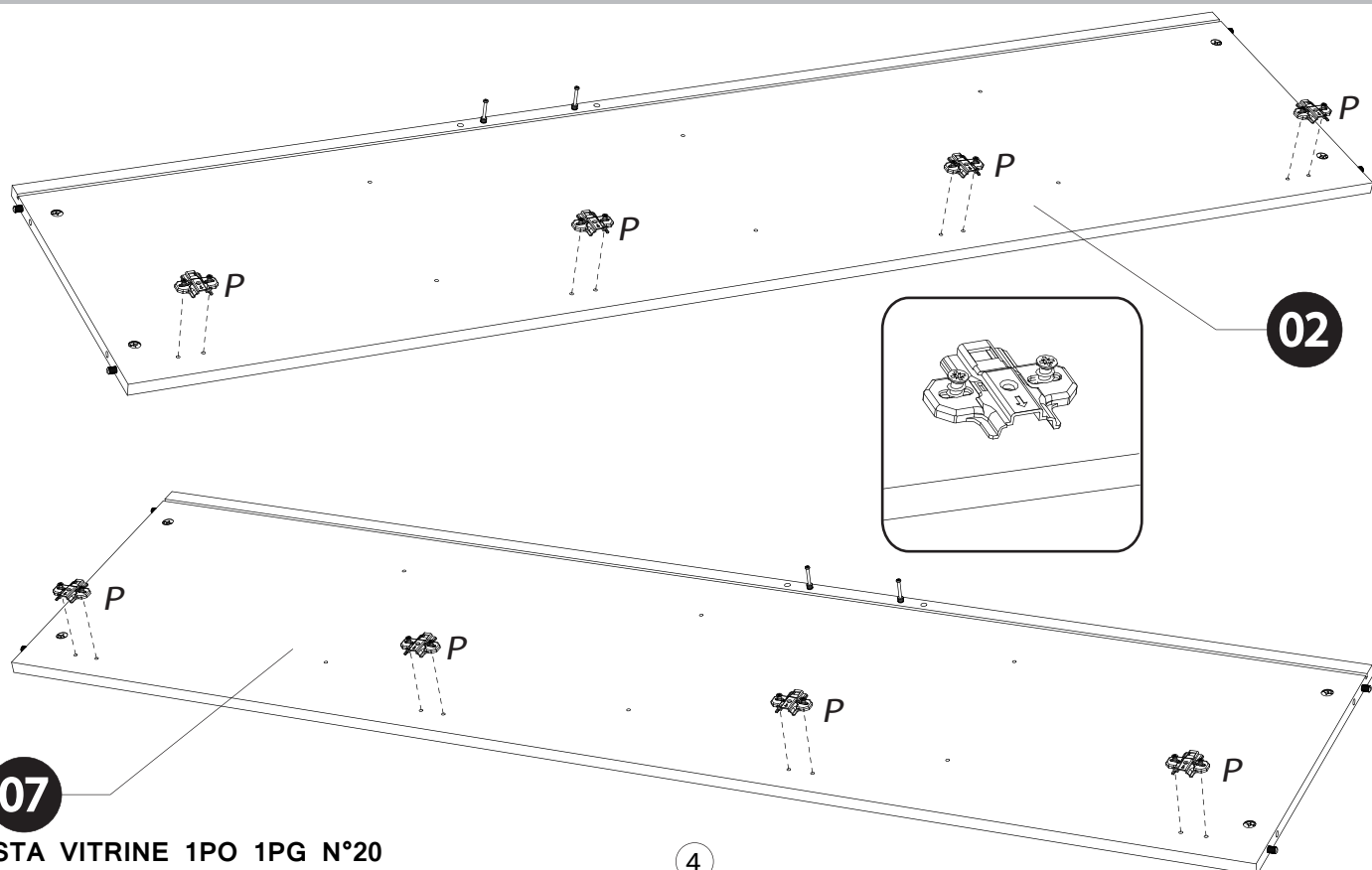
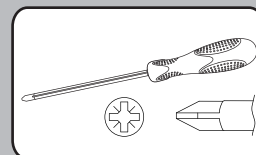
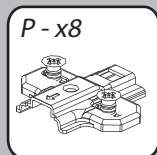

5

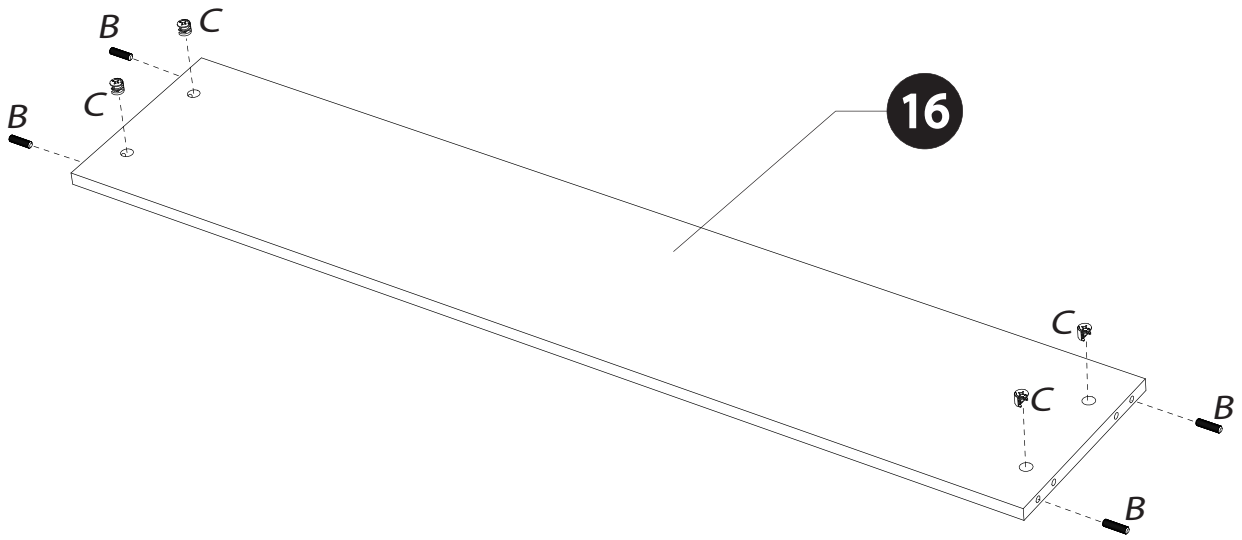
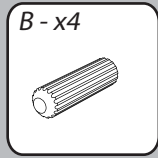
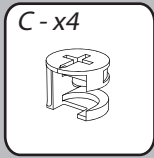

6

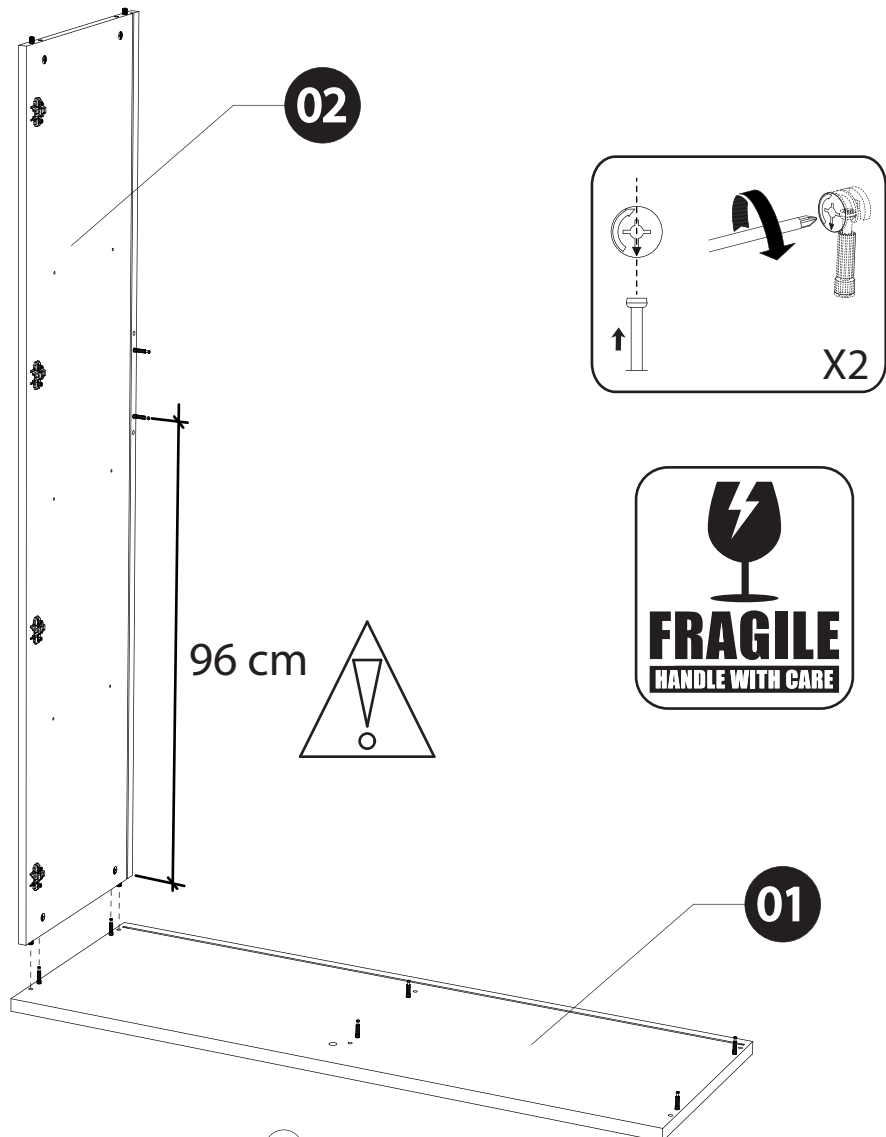
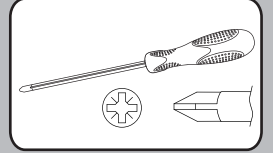

7

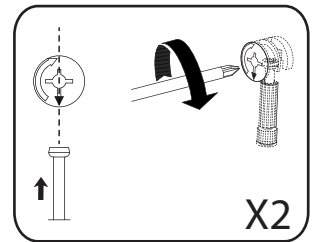
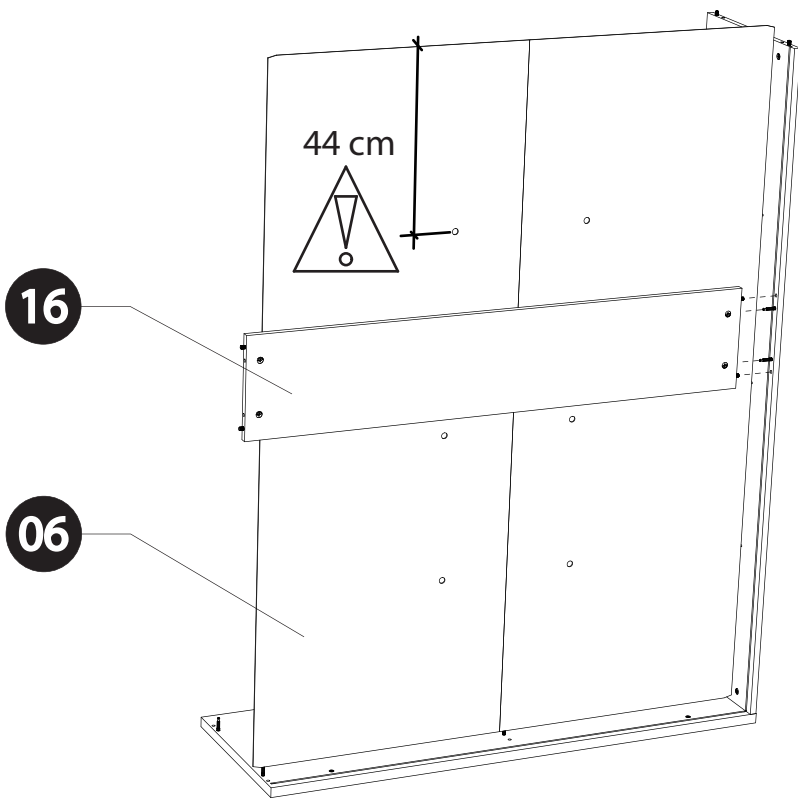
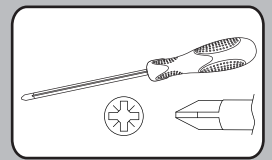
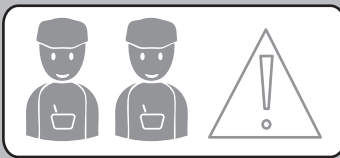

8

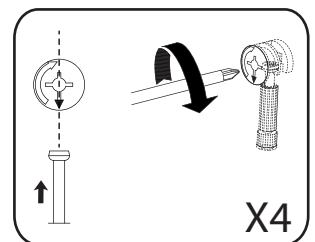
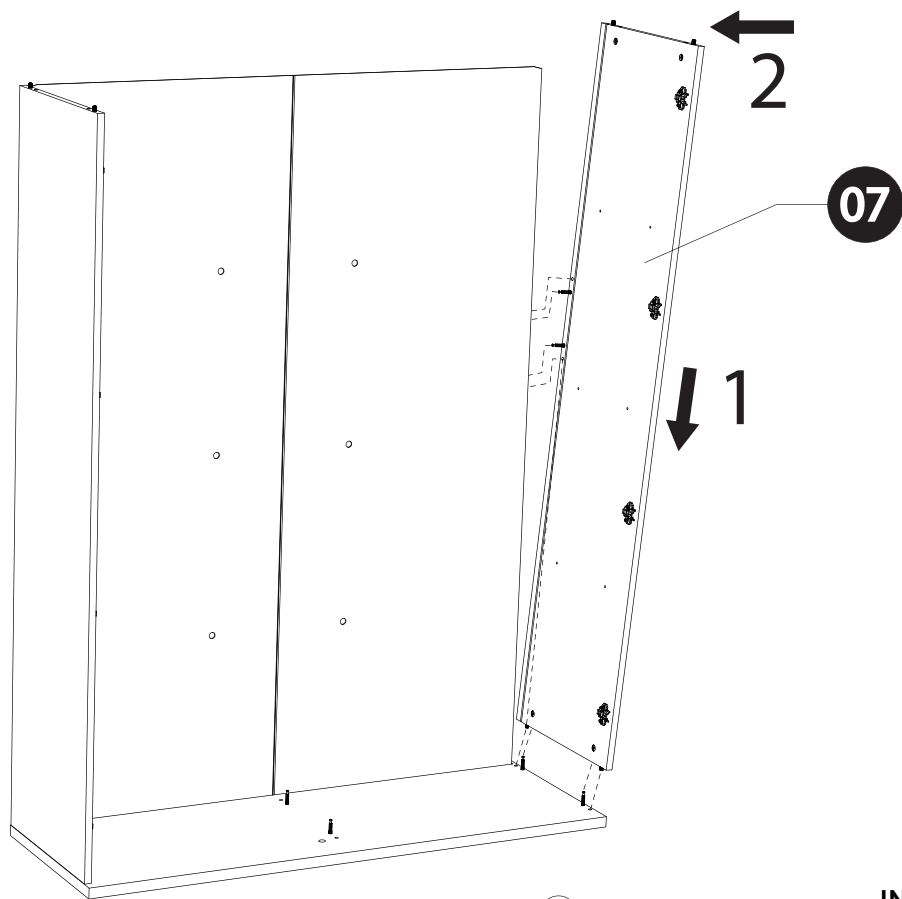
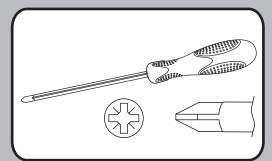
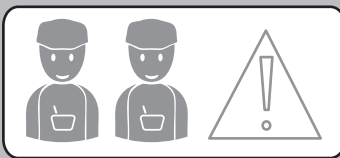

6

9

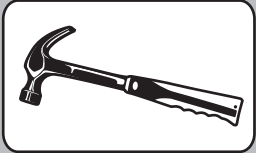
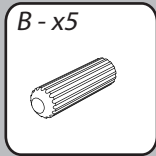
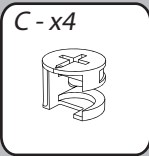

03

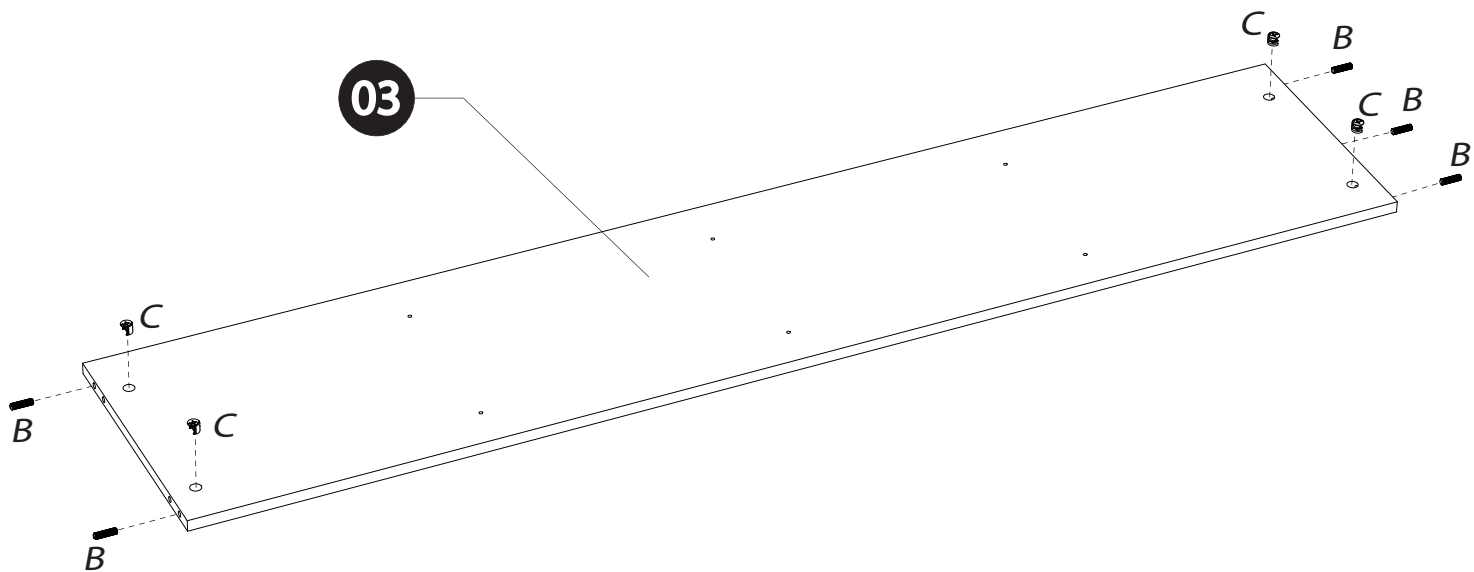

10

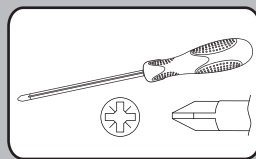
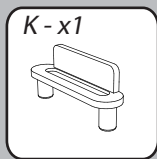
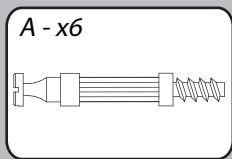

08

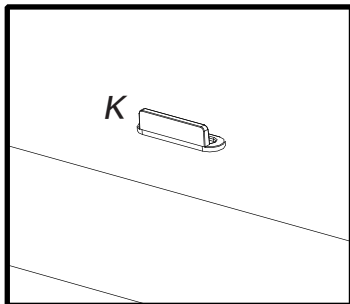
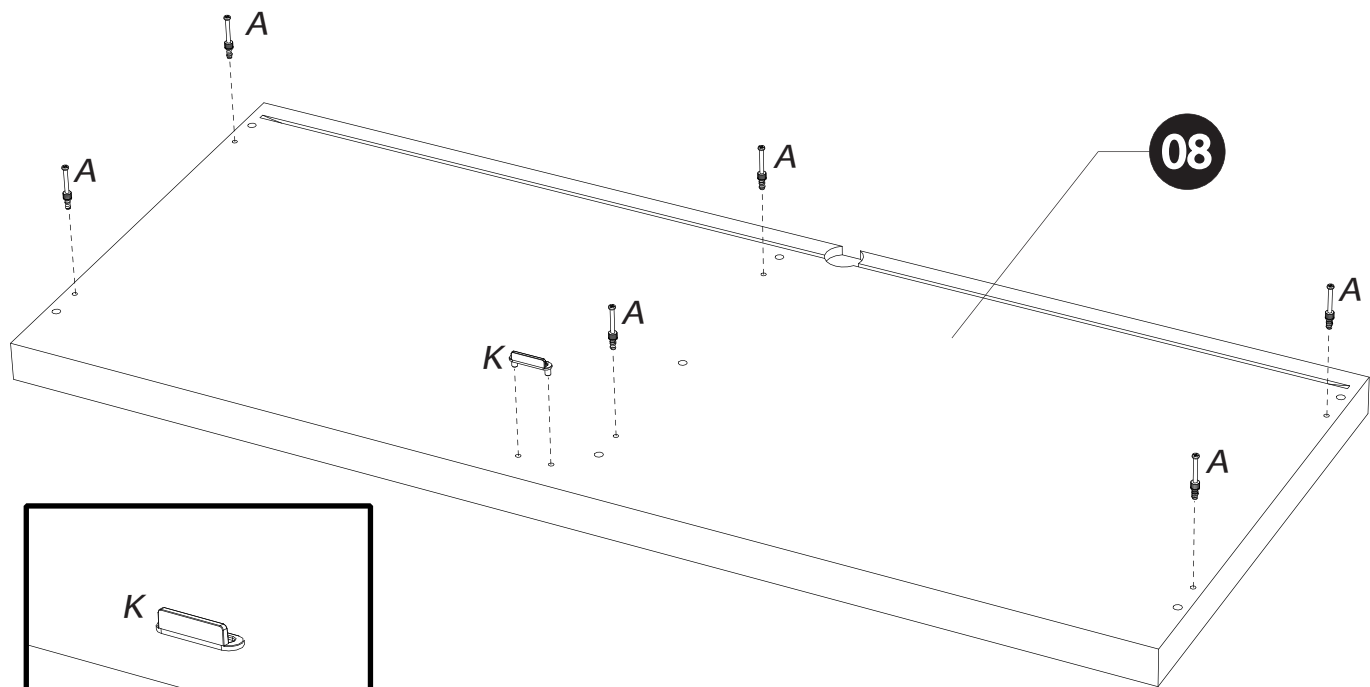

11

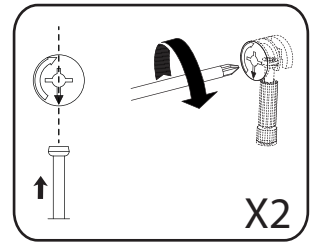
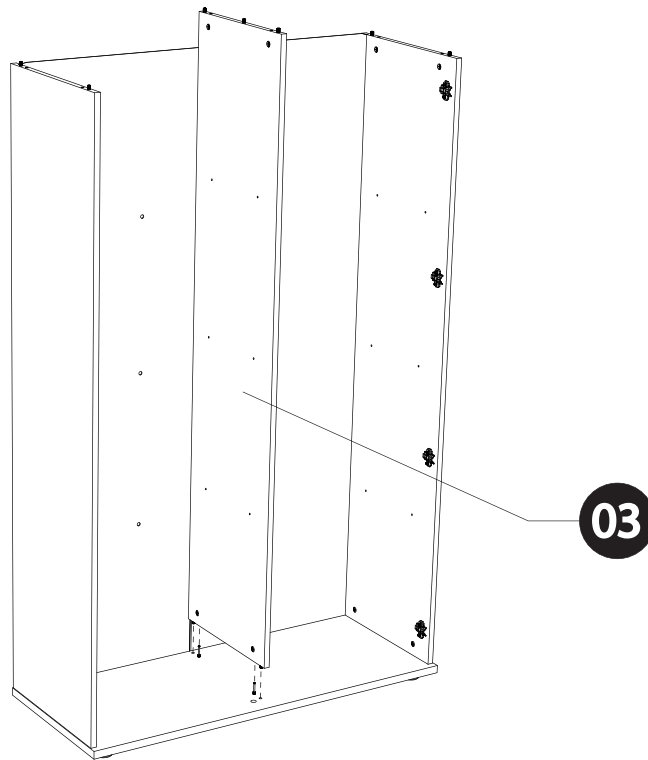
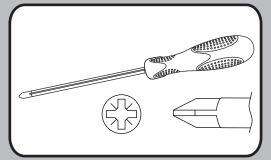
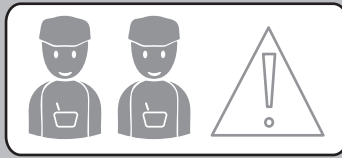

12

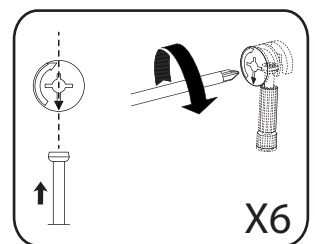
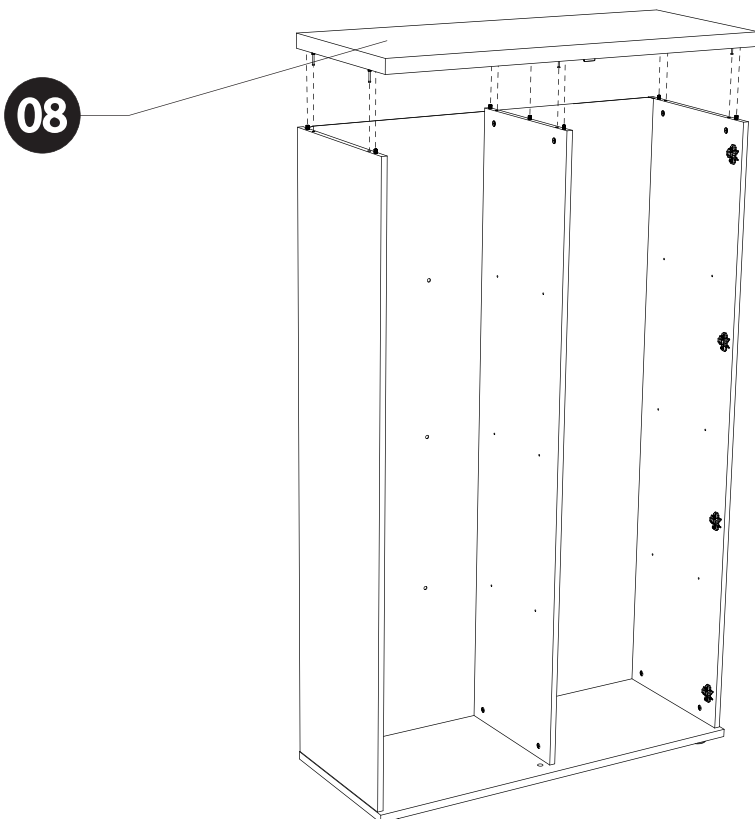
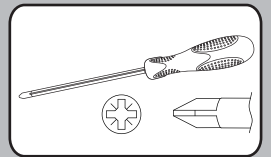
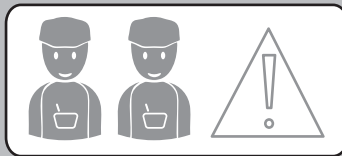

13

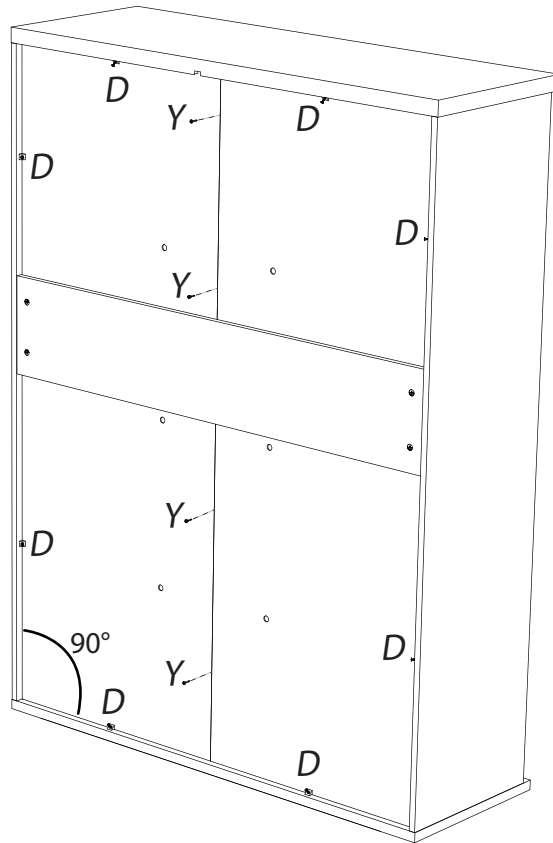
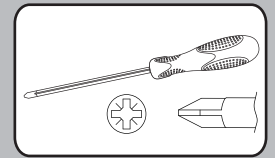
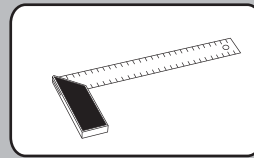
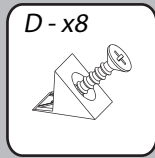
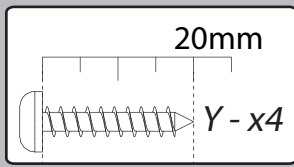

14

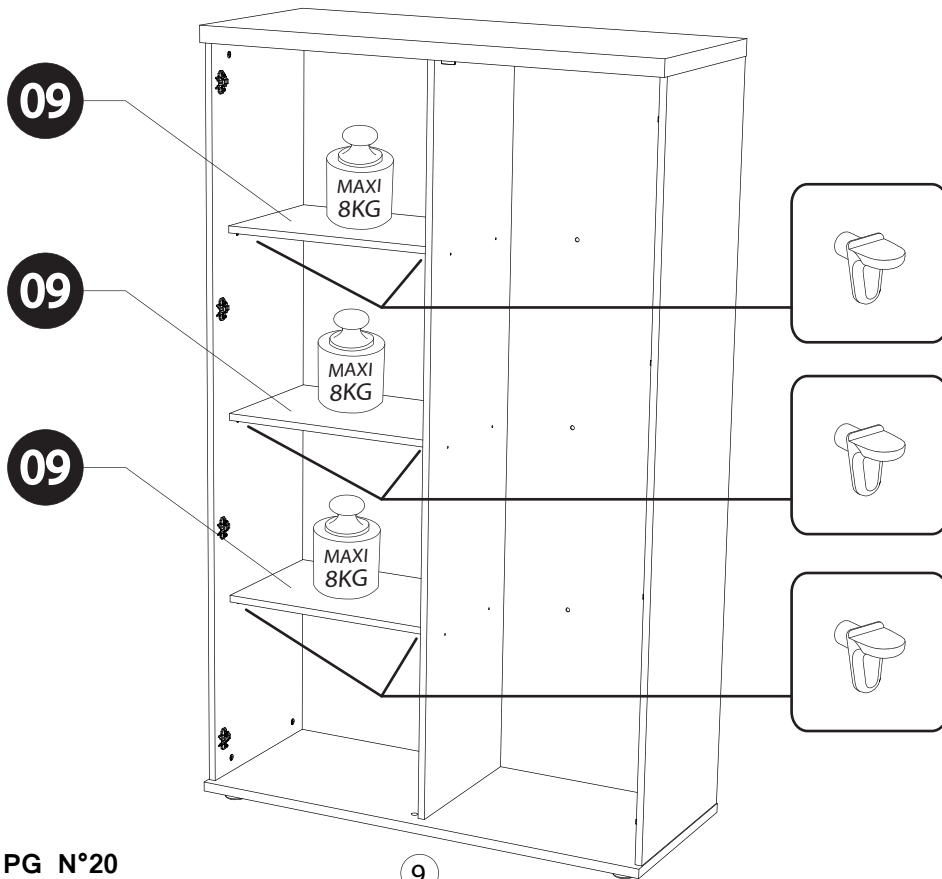
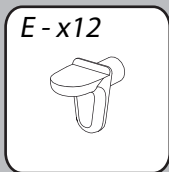



F

INSTRUCTION GÉNÉRALE DU LUMINAIRE

REMARQUES

SCIAE Dienville n'est pas responsable des dommages résultant :

- d'un mauvais montage
- de l'emploi d'outils inappropriés
- de changements techniques de l'ensemble
- du non-respect de cette instruction.

A LIRE AVANT DE PROCEDER AU MONTAGE

L'ensemble est conçu pour une tension d'alimentation de 230V ~ 50Hz, il est fait en 2e classe de protection et marqué par un symbole  approprié.

L'indice de protection de l'ensemble : IP20

Brancher l'ensemble à une prise de 230V ~ 50Hz en bon état de fonctionnement.

Le montage doit être effectué conformément à l'instruction.

ATTENTION !

Lors du montage, il faut strictement débrancher l'ensemble du courant 230V ~ 50Hz, respecter les règles de sécurité et rester particulièrement prudent.

La puissance électrique totale des montures de l'ensemble ne peut pas dépasser la puissance nominale du chargeur.

Les montures désignées par le symbole  doivent être installées sur une surface incombustible. Pour nettoyer, il faut utiliser uniquement un chiffon sec et ne jamais utiliser de produits chimiques.

MONTAGE

Effectuer le montage dans l'ordre conforme au mode d'emploi.

Il faut s'assurer que toutes les connexions électriques et les fixations soit effectuées correctement, de façon à exclure tout fonctionnement défectueux.

Lors du déplacement des meubles, veuillez particulièrement à ne pas endommager l'isolation des câbles électriques de l'ensemble.

EN

GENERAL LUMINAIRE INSTRUCTION

NOTES

SCIAE Dienville is not liable for any damage resulting from :

- a bad assembly
- the use of inappropriate tools
- of technical changes to the whole
- for non-compliance with this instruction.

TO BE READ BEFORE ASSEMBLY

The unit is designed for a supply voltage of 230V ~ 50Hz, it is made in 2nd protection class and marked with an appropriate symbol .

The protection index of the set : IP20

Connect the unit to a 230V ~ 50Hz socket in good working order.

Installation must be carried out in accordance with the instructions.

ATTENTION !

During installation, the entire 230V ~ 50Hz power supply must be strictly disconnected, respect the safety rules and remain particularly careful.

The total electrical power of the frames in the set may not exceed the charger's power rating.







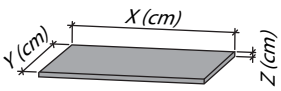
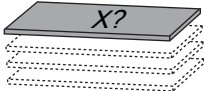
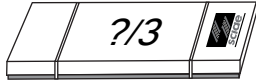

Frames marked with the symbol  symbol must be installed on a non-combustible surface. To clean, use only a dry cloth and never use chemicals.

ASSEMBLY

Carry out the assembly in the order described in the operating instructions.

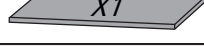
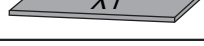
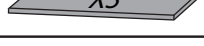
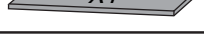
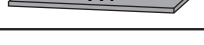
Make sure that all electrical connections and fixings are carried out correctly, so that faulty operation is excluded.

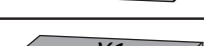
When moving the furniture, be particularly careful not to damage the following when moving it the insulation of the electric cables of the whole.

<i>DESIGNATION</i>		N°		
Dessous	110.4 x 45.4 x 2.2	1		1
Côté gauche	172 x 43.4 x 1.6	2		2
Séparation	172 x 39.3 x 1.6	3		2
Derrière pliant	172.9 x 107.7 x 0.25	6		2
Côté droit	172 x 43.4 x 1.6	7		2
Dessus	110.4 x 45.4 x 3.8	8		1
Tablette	52.5 x 34 x 1.6	9		1
Porte gauche	171.3 x 41.8 x 1.8	10		3
Porte droite	171.3 x 22.2 x 1.8	11		3
Raidisseur	106.8 x 25 x 1.6	16		1
Recharge de porte	171.2 x 22.2 x 1.6	27		3
Tablette verre	52.4 x 37.5 x 0.5	29		3
Glace de porte	171.3 x 35.4 x 0.5	34		3

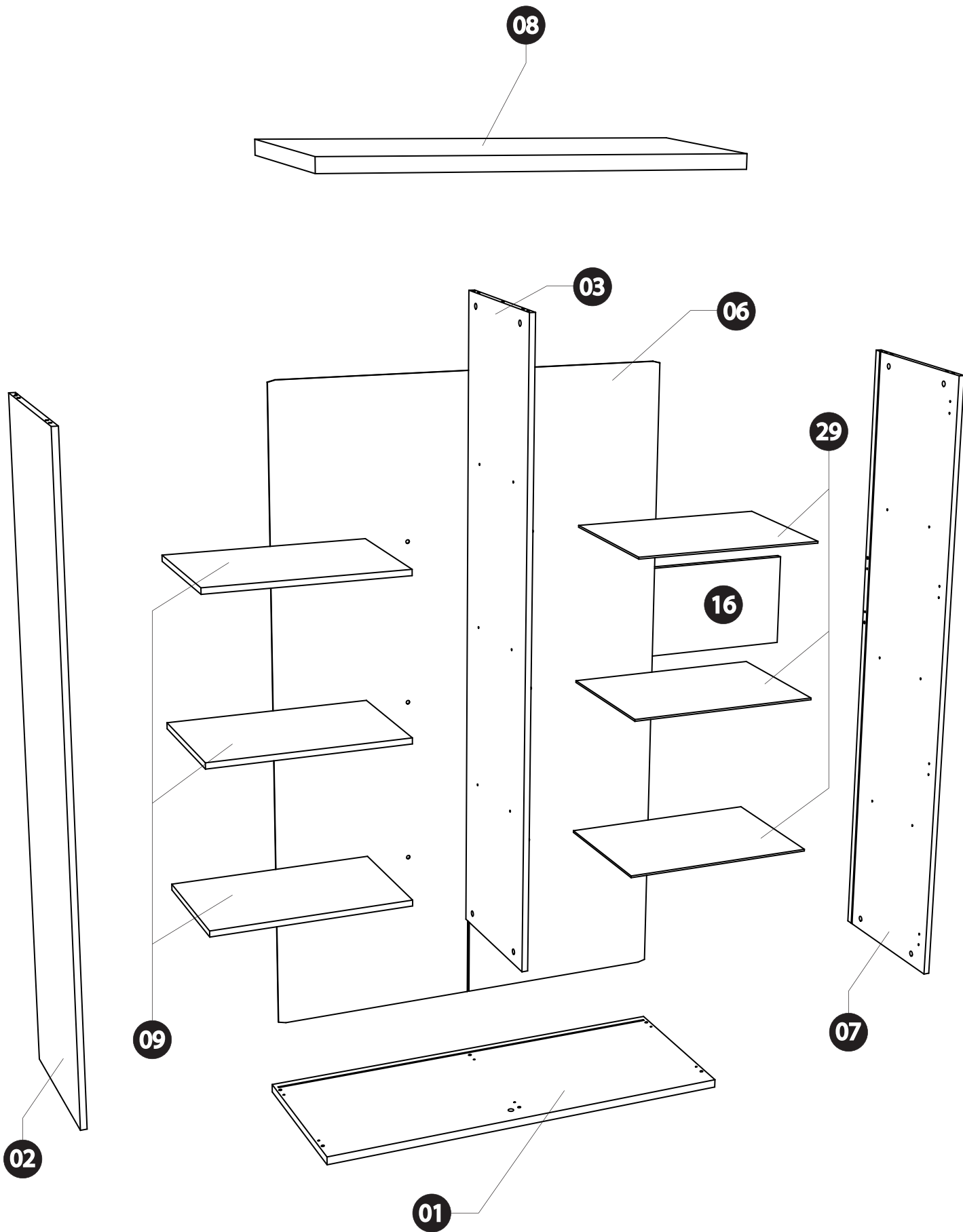

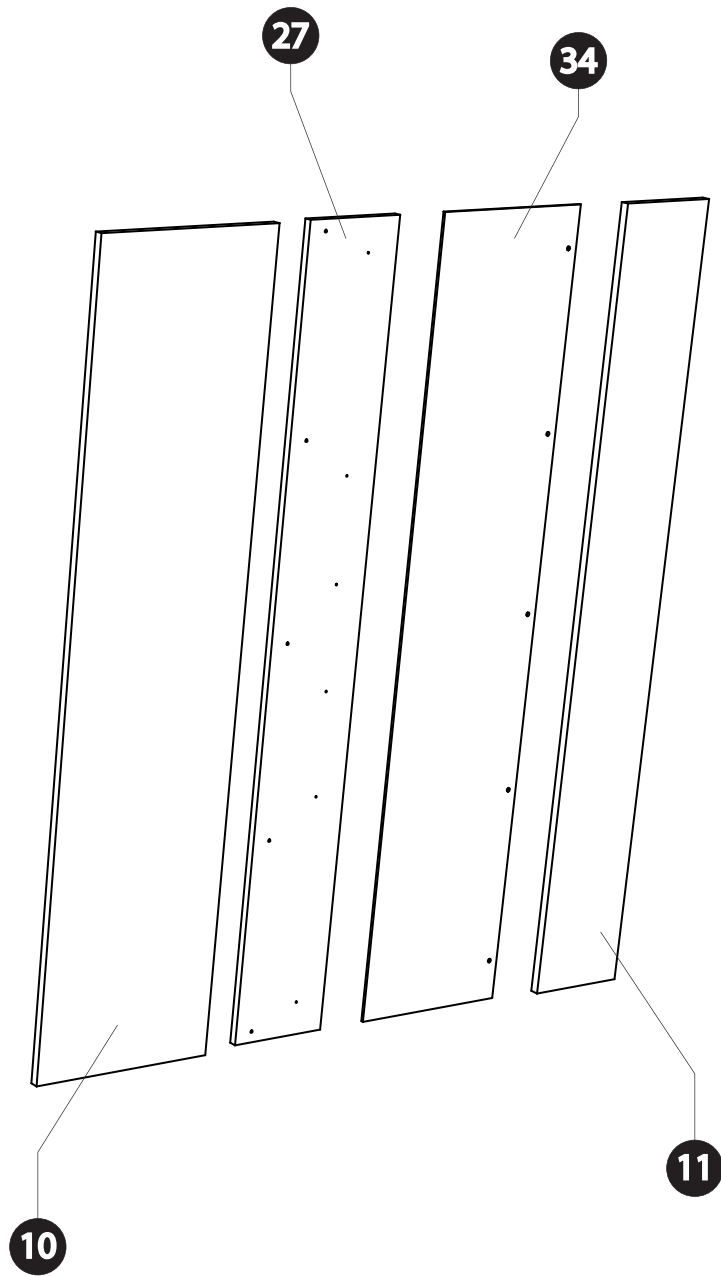

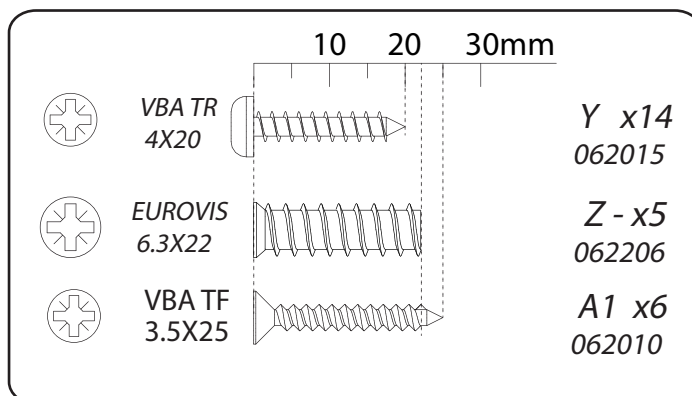
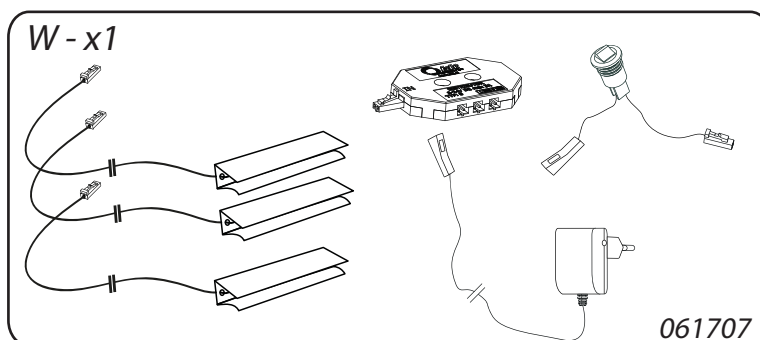
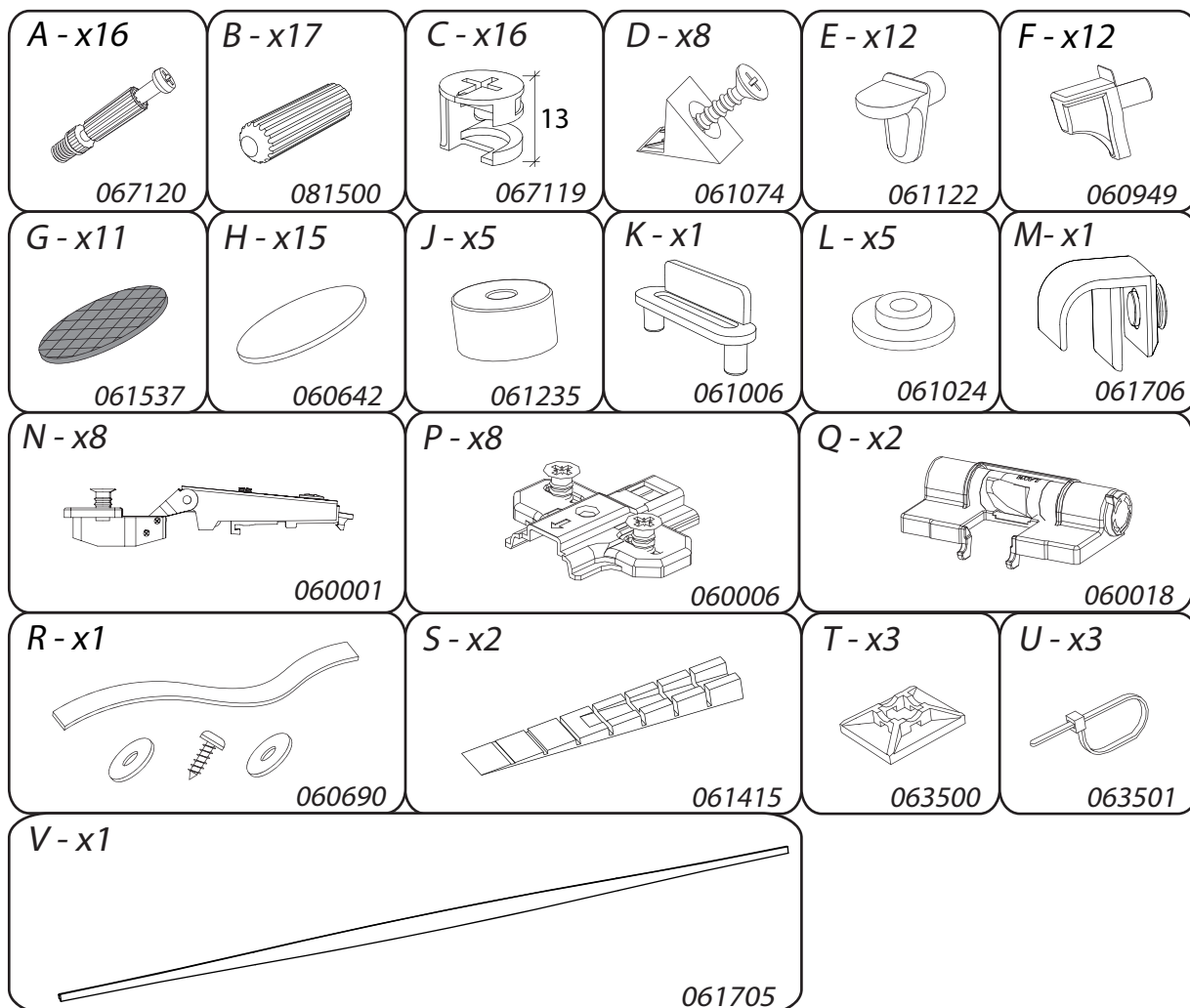

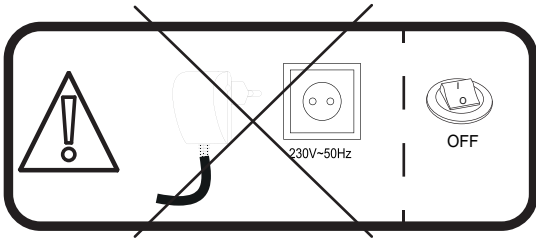
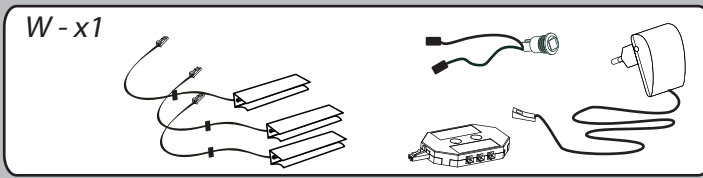

Ce luminaire est un produit de décoration.
 Ce luminaire ne convient pas pour l'illumination d'une pièce d'un ménage.
This light is a decoration product.
This light is not suitable for lighting a room in a house.

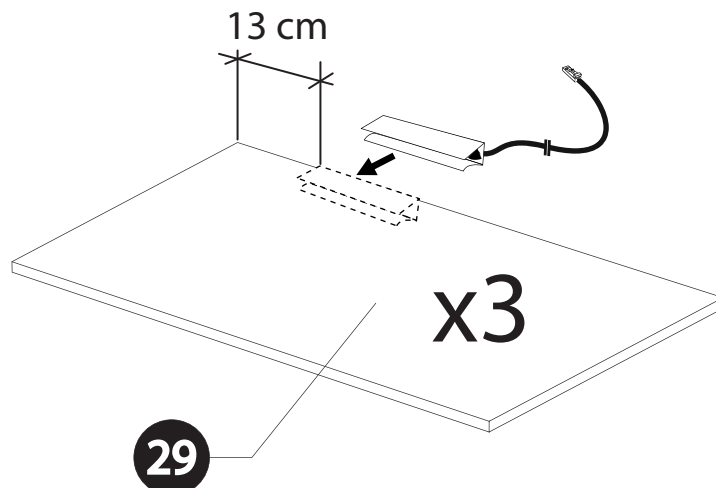
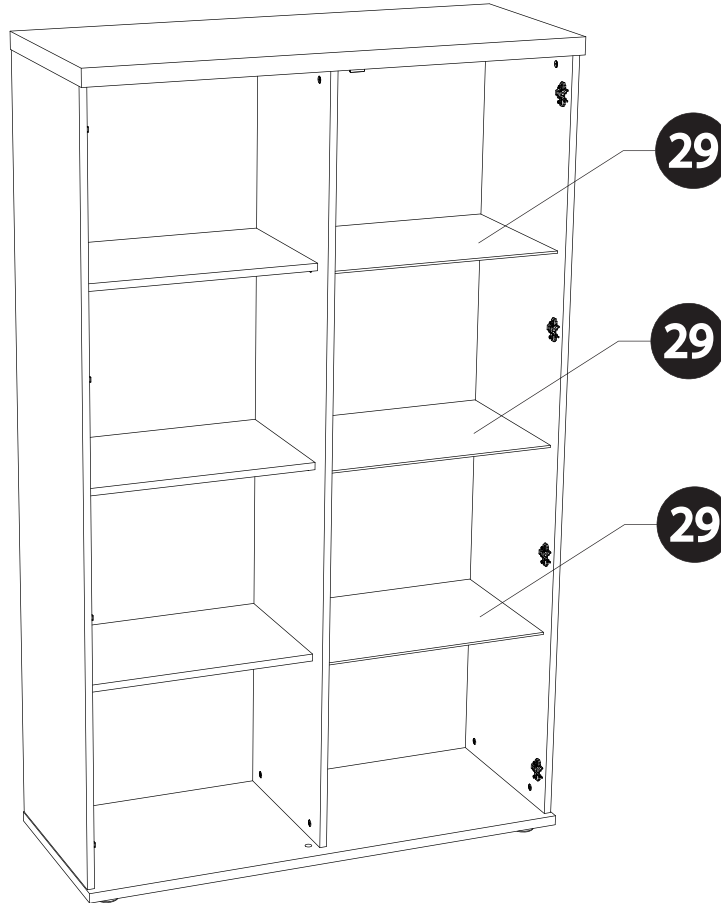

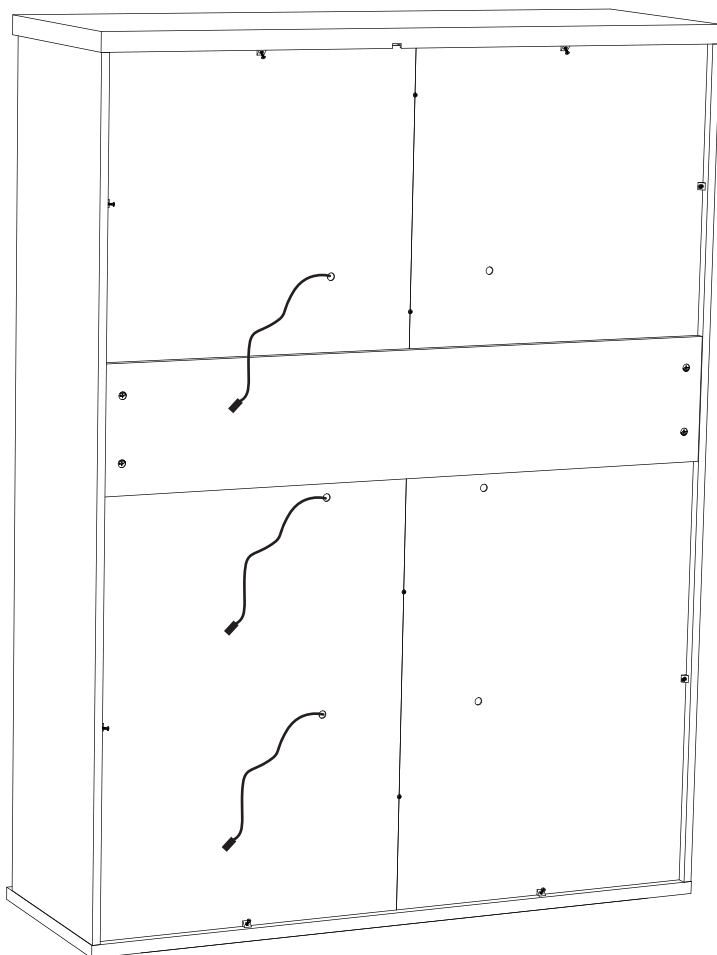
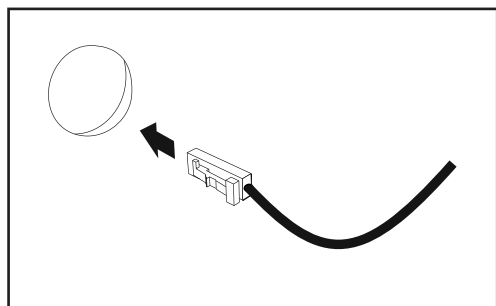
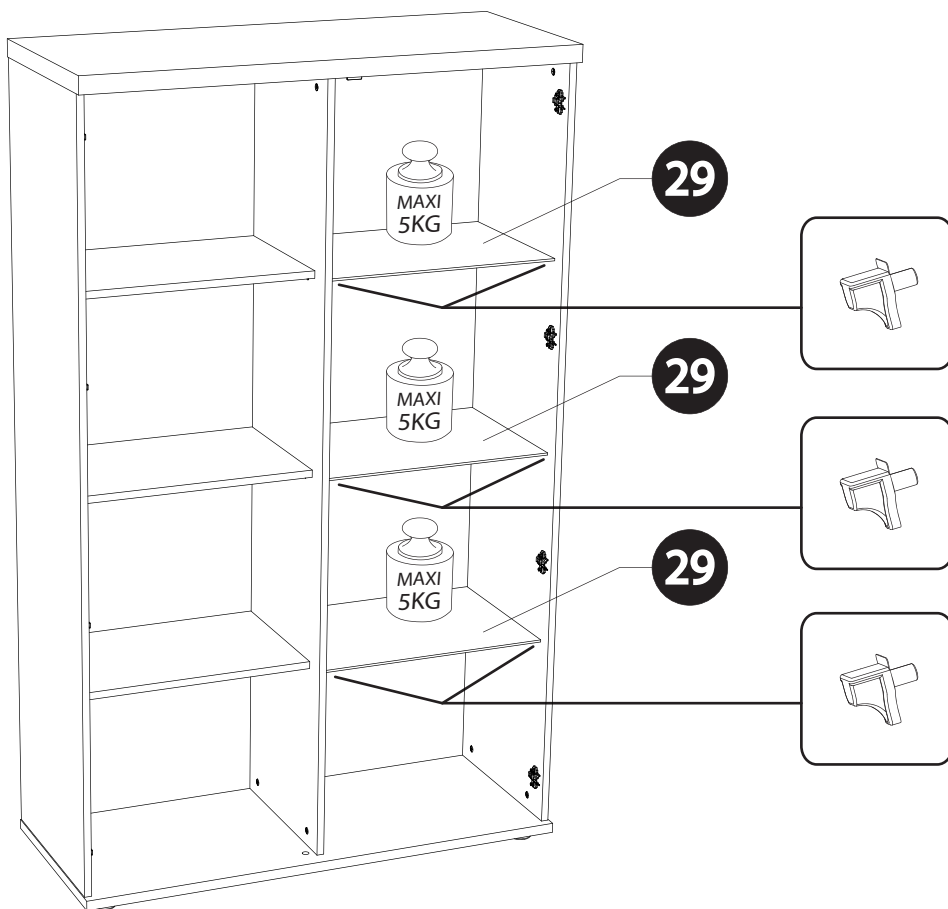

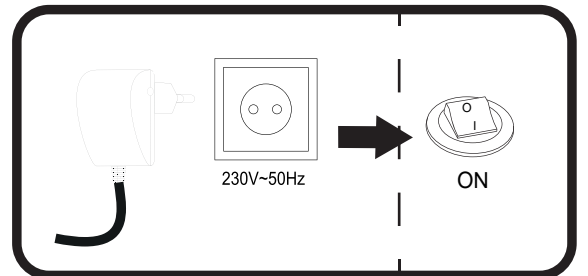
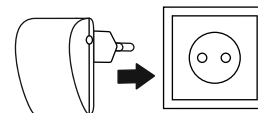
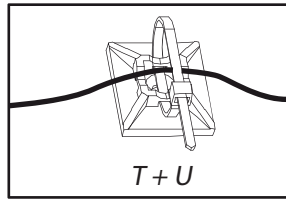
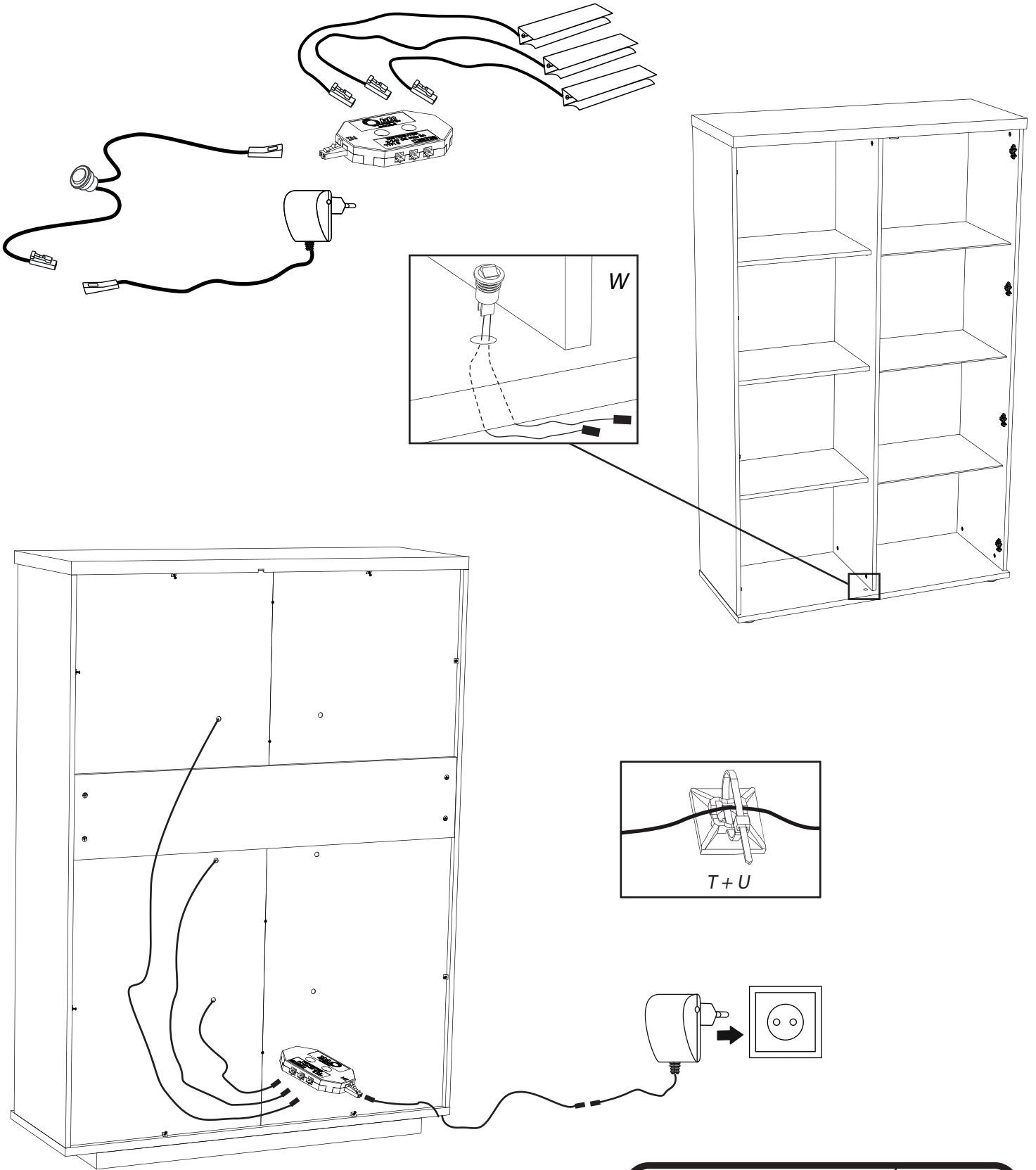
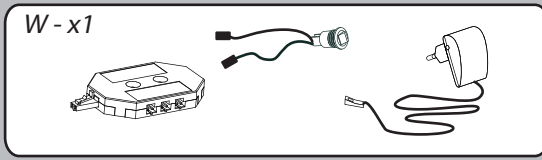
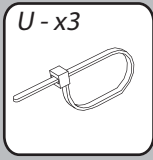
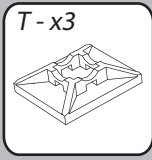

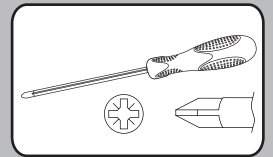
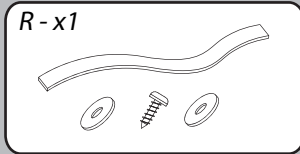

FRANCAIS: Pour votre sécurité il est impératif de fixer votre meuble au mur.
 Pour cela tous les meubles hauts disposent d'un dispositif d'accrochage, disponible à l'intérieure de votre colis.
 Si tel n'est pas le cas, veuillez en faire la demande auprès de votre revendeur.
 Cela empêche toute chute accidentelle du meuble.

ENGLISH: For your safety it is compulsory to fix your furniture to the wall.
 For this reason, all the high cabinets have a hanging system, available inside your package.
 If this is not the case, please contact your reseller.
 This prevents any accidental falling of the furniture.

DEUTSCH: Zu Ihre Sicherheit muss Ihre Möbel an der Wand befestigt.
 Aus diesem Grund verfügen alle Hochschränke über eine Aufhängevorrichtung, die in der verpackung steht.
 Falls nicht, bitte verwenden sie sich an ihren Händler.
 Es vermeidet jede zufällig fallen.

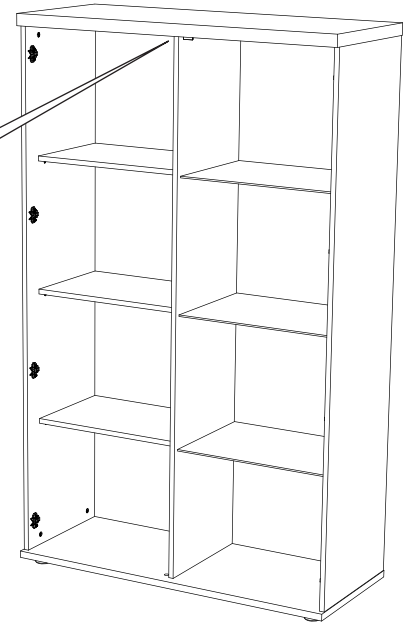
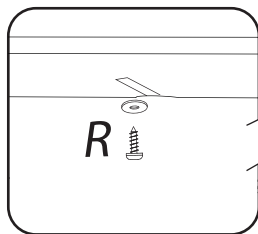

FRANCAIS
IMPORTANT: La vis fournie avec le dispositif anti-bascule est destinée à fixer le dispositif dans le meuble.
 Pour la fixation au mur, compléter par une vis adaptée au support mural.
 En cas de doute, contacter un magasin de bricolage.

ENGLISH
IMPORTANT: The screw supplied together with the anti-topple bracket is to be used only for fixing the anti-topple bracket to the furniture.
 In addition to this, you will need to choose a screw or fitting which is suitable for securing the bracket to the kind of walls you have. If you are unsure about what type of screw to use contact your local hardware store.

DEUTSCH
WICHTIG: Die dem kippschutz beigefügten schrauben sind ausschließlich für die befestigung des kippschutzes am möbelstück vorgesehen. Für die befestigung des kippschutzes an der wand benötigen sie zusätzlich schrauben oder beschläge, die zur beschaffenheit der wand passen. Falls sie nicht sicher sind, welche art von schrauben geeignet sind, wenden sie sich bitte an den fachhandel.

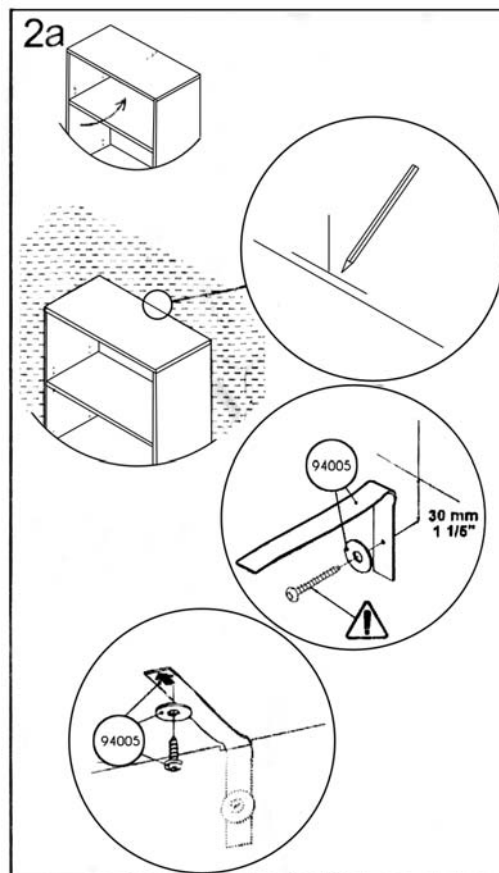

19

S - x2

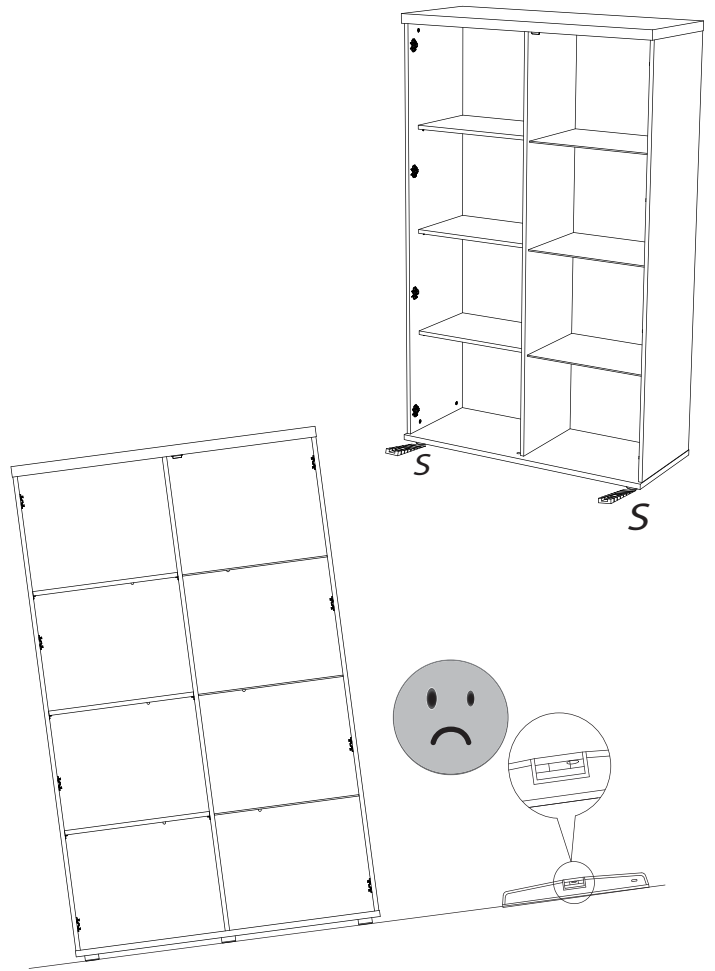
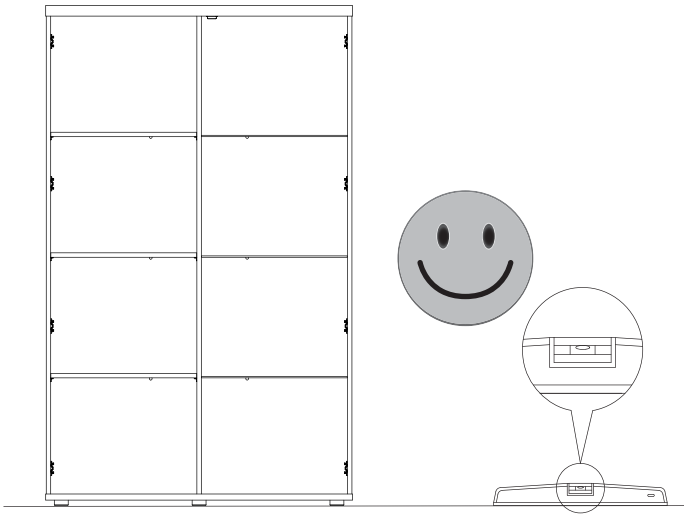
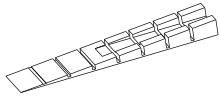

20

N - x8

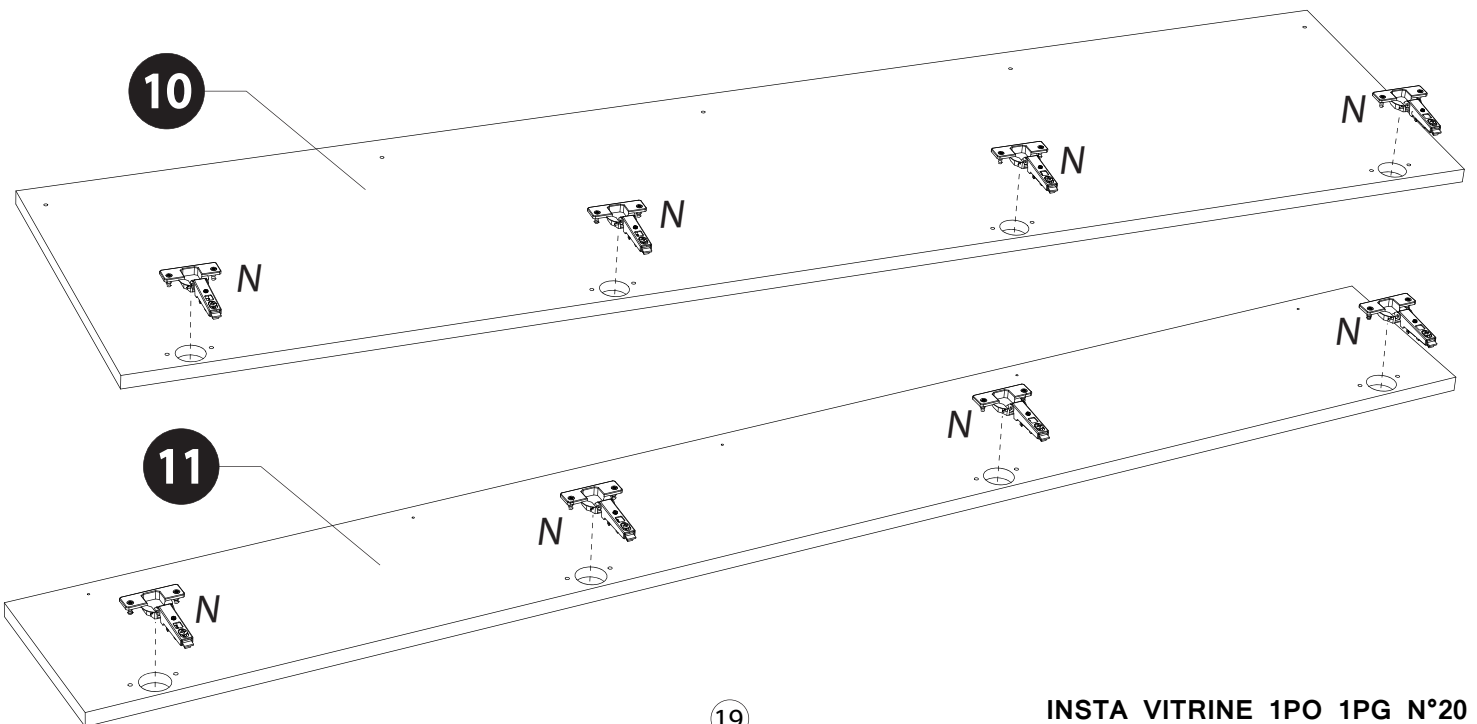
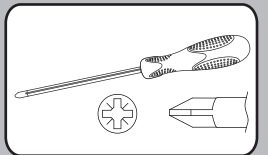
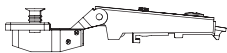

21

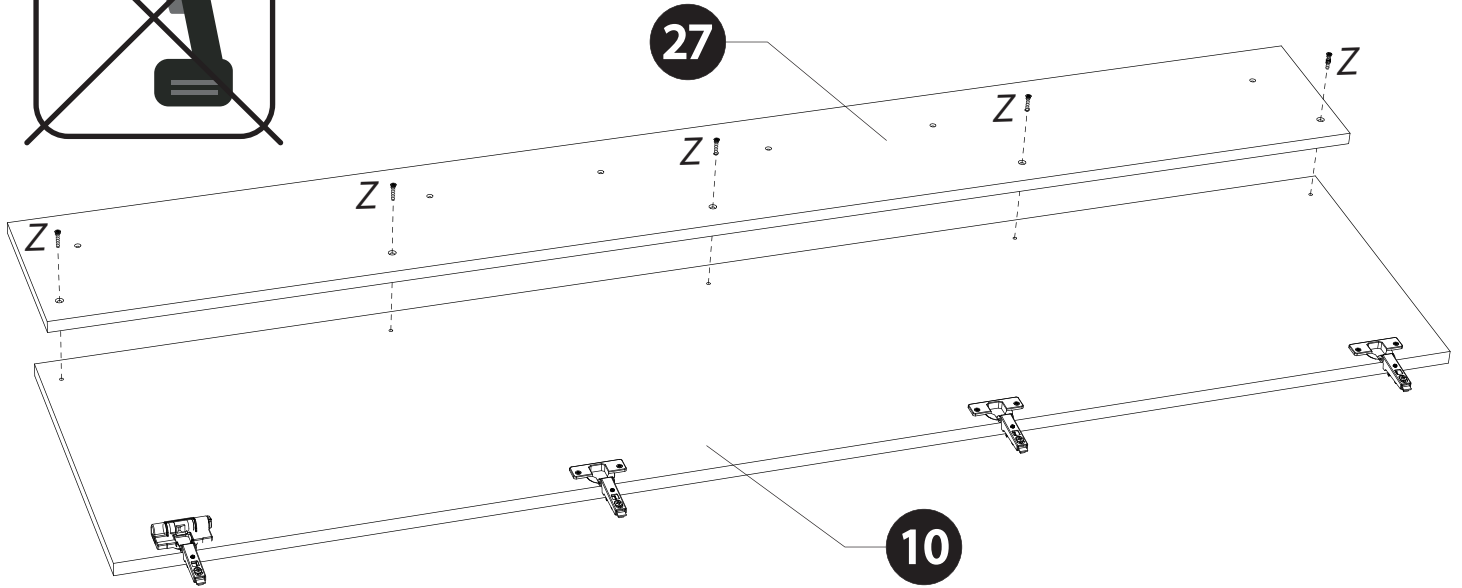
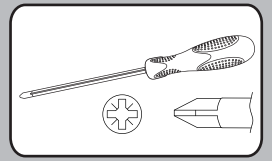
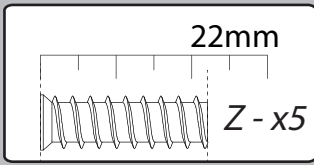

22

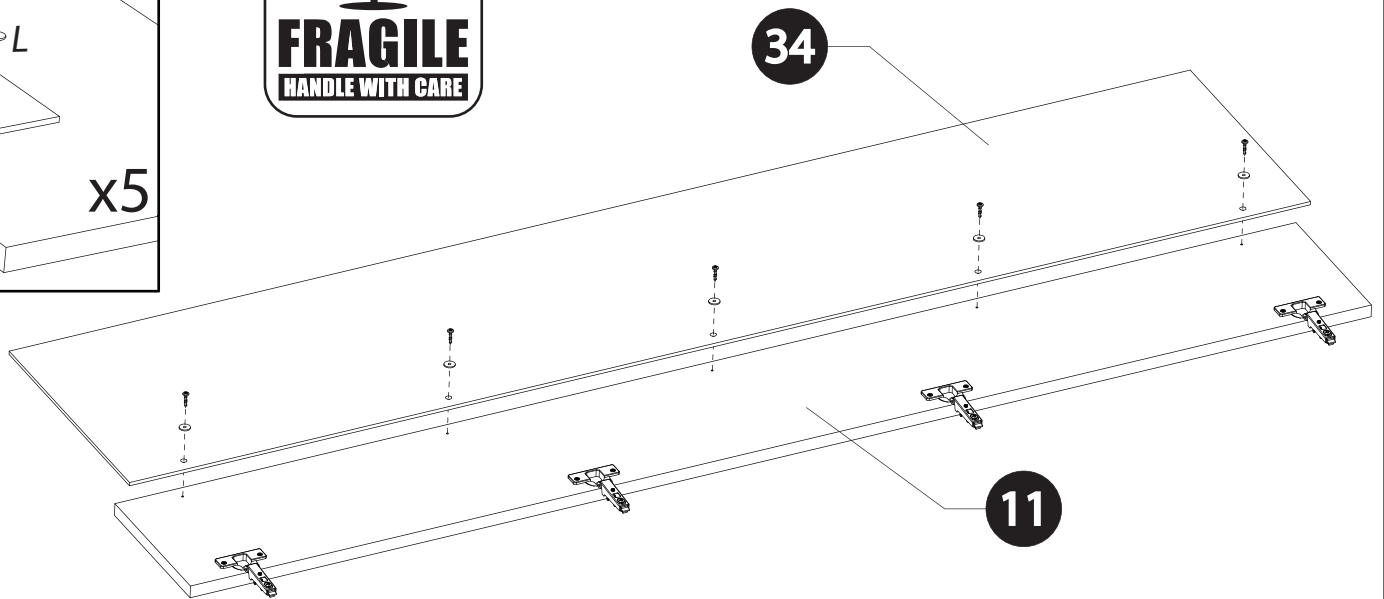
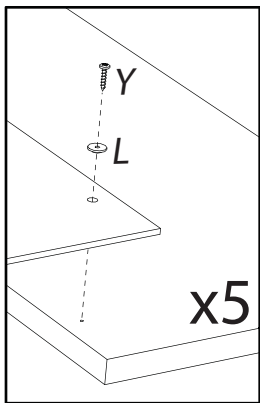
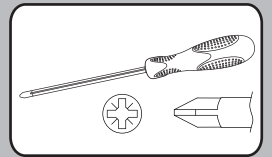
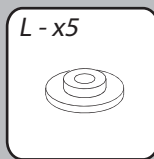
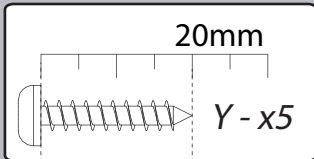

Q - x2

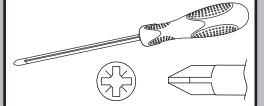
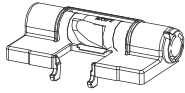

10

11

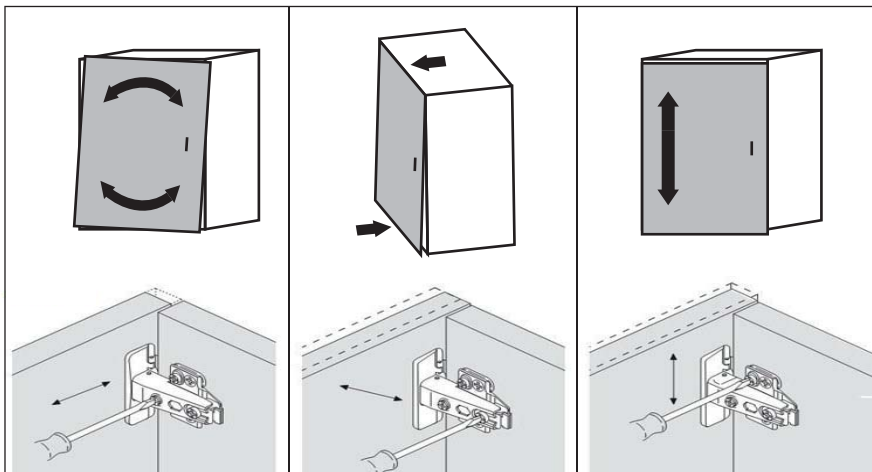
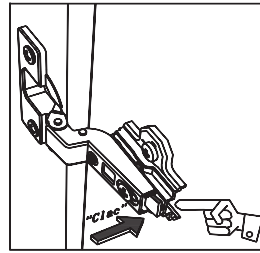
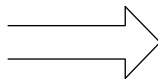
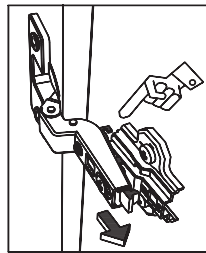
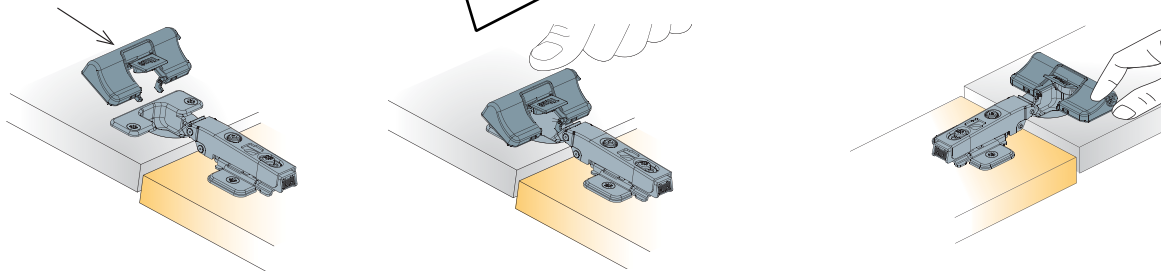
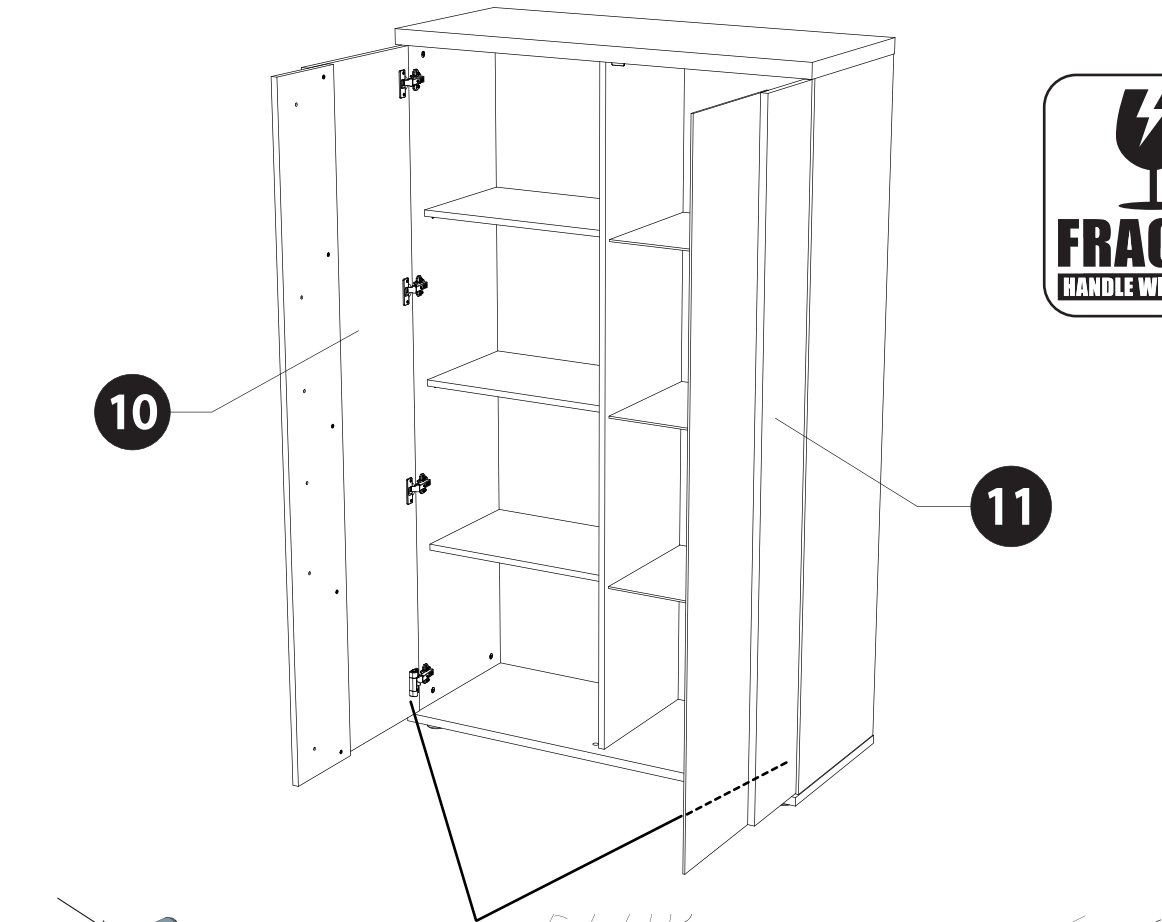

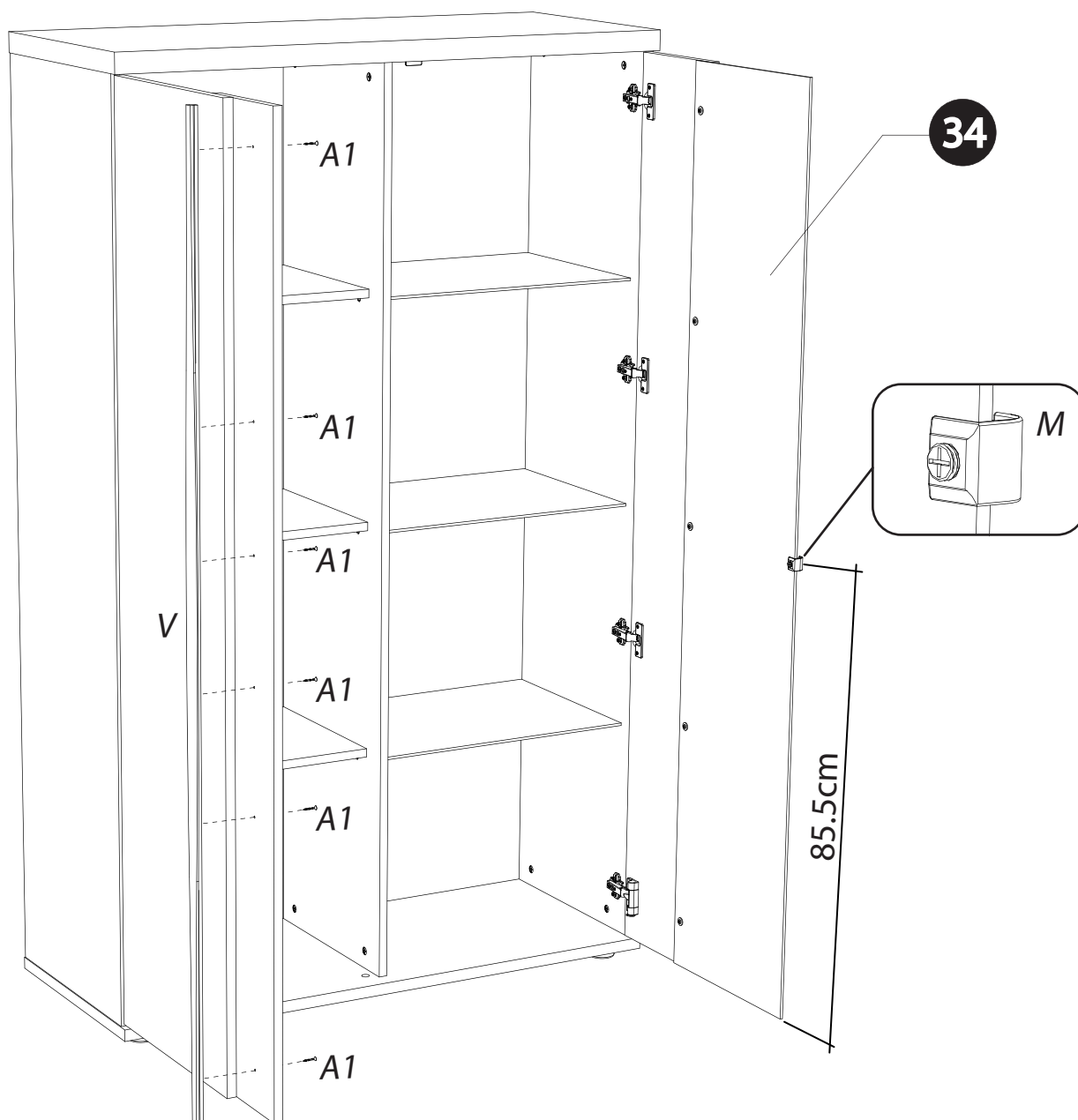
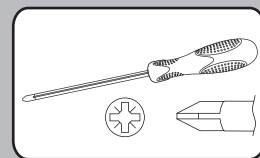
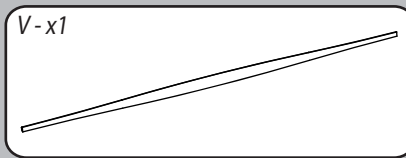
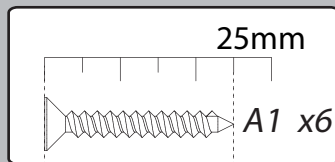
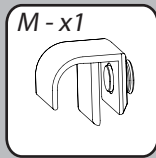

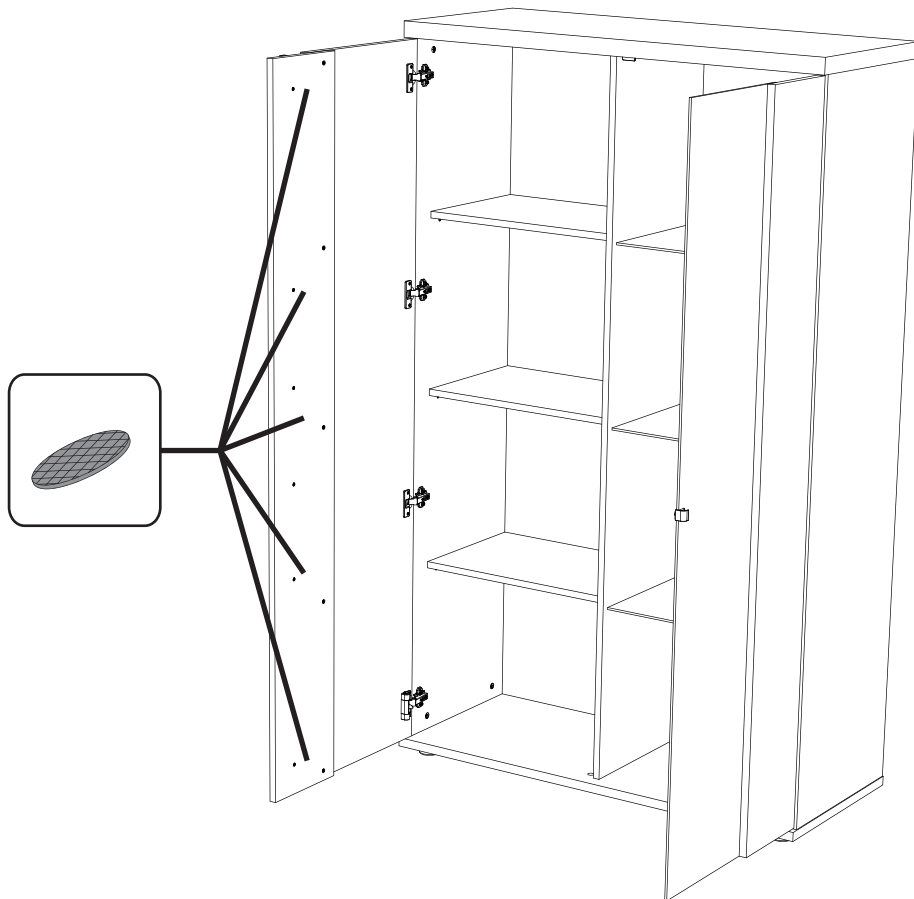
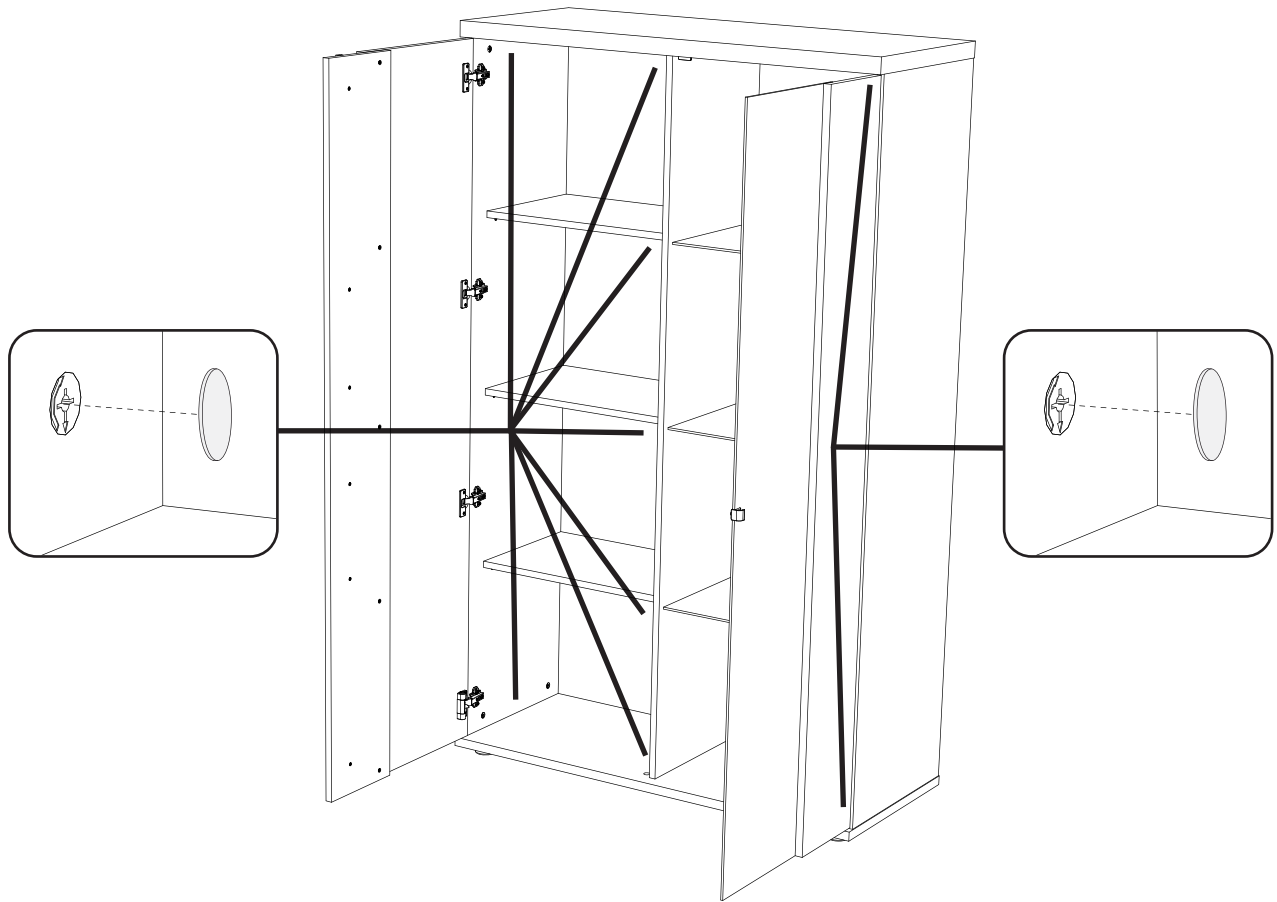
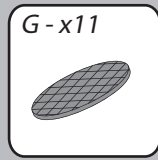
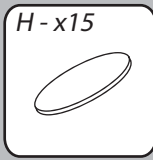

FRANCAIS

Recommandations de démontage :

En cas de déménagement, il convient de procéder au démontage de votre meuble, en ôtant toute la visserie.

ENGLISH

Disassembly advices:

In case of moving, it is needed to dismantle the furniture removing the fittings.

DEUTSCH

Empfehlungen für die Demontage:

Bei Transport bitte alle Beschläge demontieren.

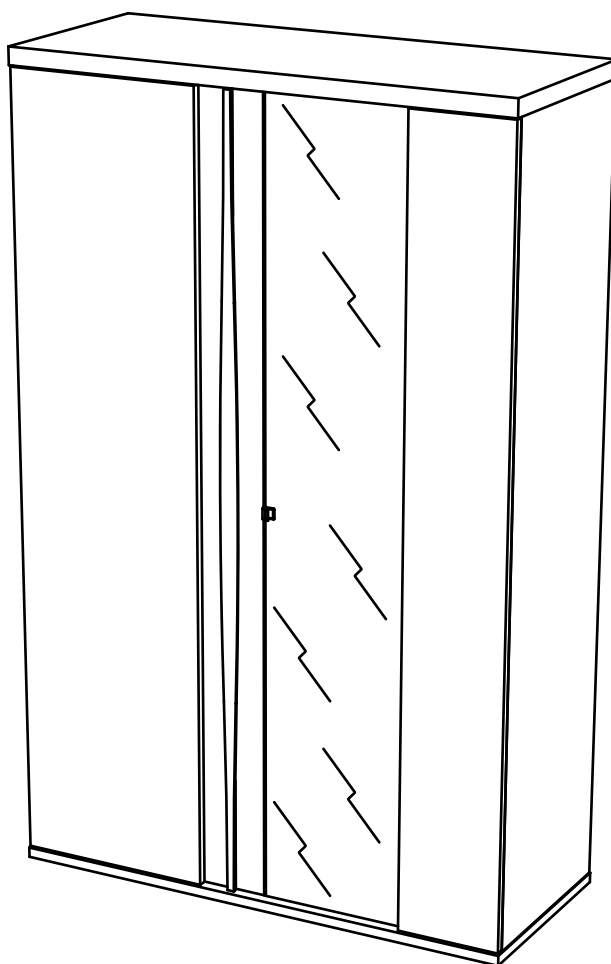

INSTA 3633 :

Vitrine 1po 1pg composé de panneaux de particules revêtus papier blanc laque blanc brillant et papier décor Grandson Oak (Chêne Blond). L'intérieur est revêtus papier blanc.

L.110.5 cm - H.180 cm - P.45.5 cm.

A monter soi-même.

"Les meubles contenant des panneaux à base de bois (panneaux de particules, panneaux de fibres, contreplaqué...) peuvent émettre des substances polluantes dans l'air intérieur. Il est ainsi recommandé, après l'installation du meuble dans son logement, d'aérer fréquemment la pièce concernée pendant au moins quatre semaines afin de réduire son exposition aux polluants émis par le meuble."