

A S387-REG2D

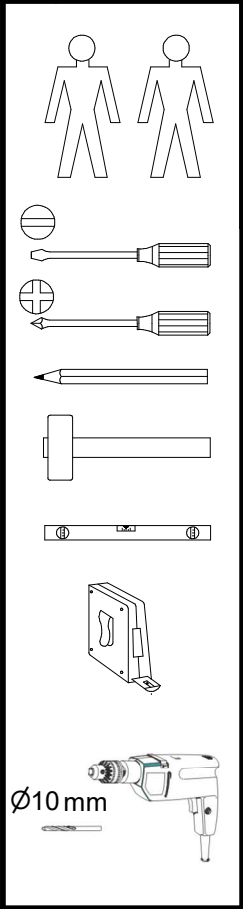

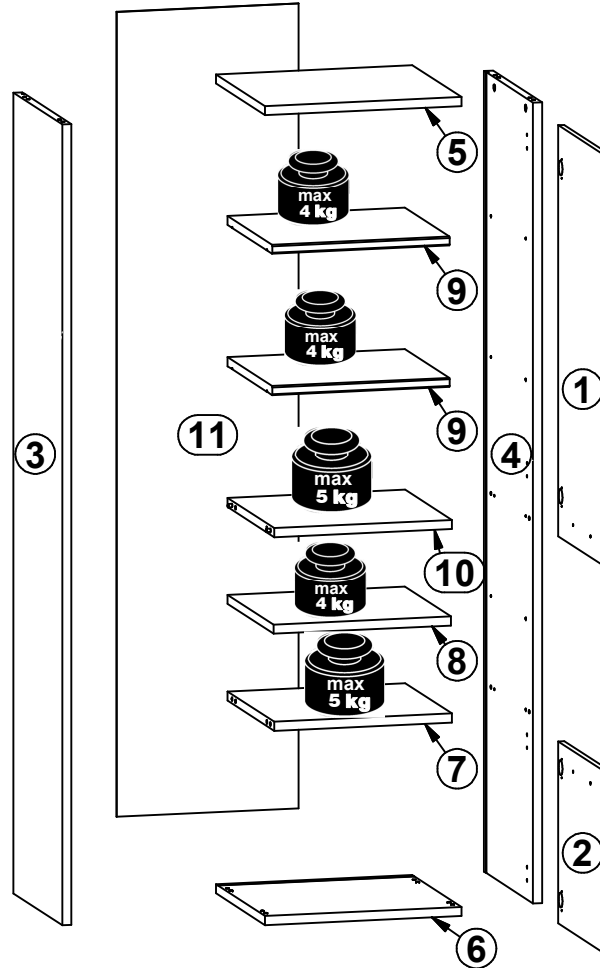



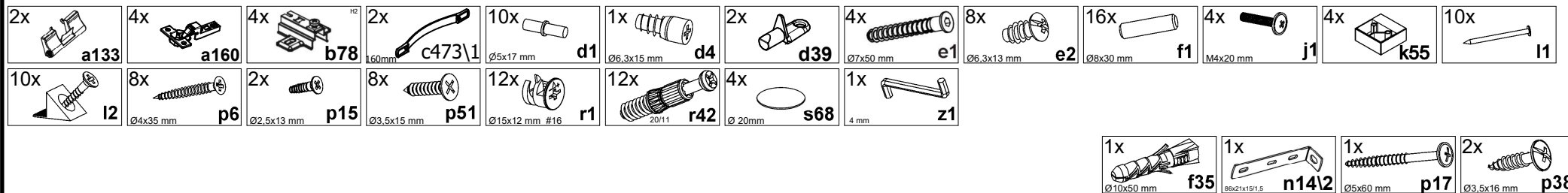
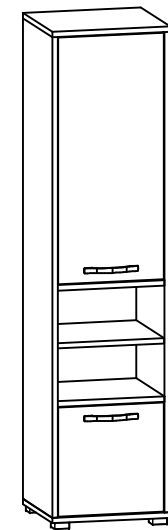

60 min

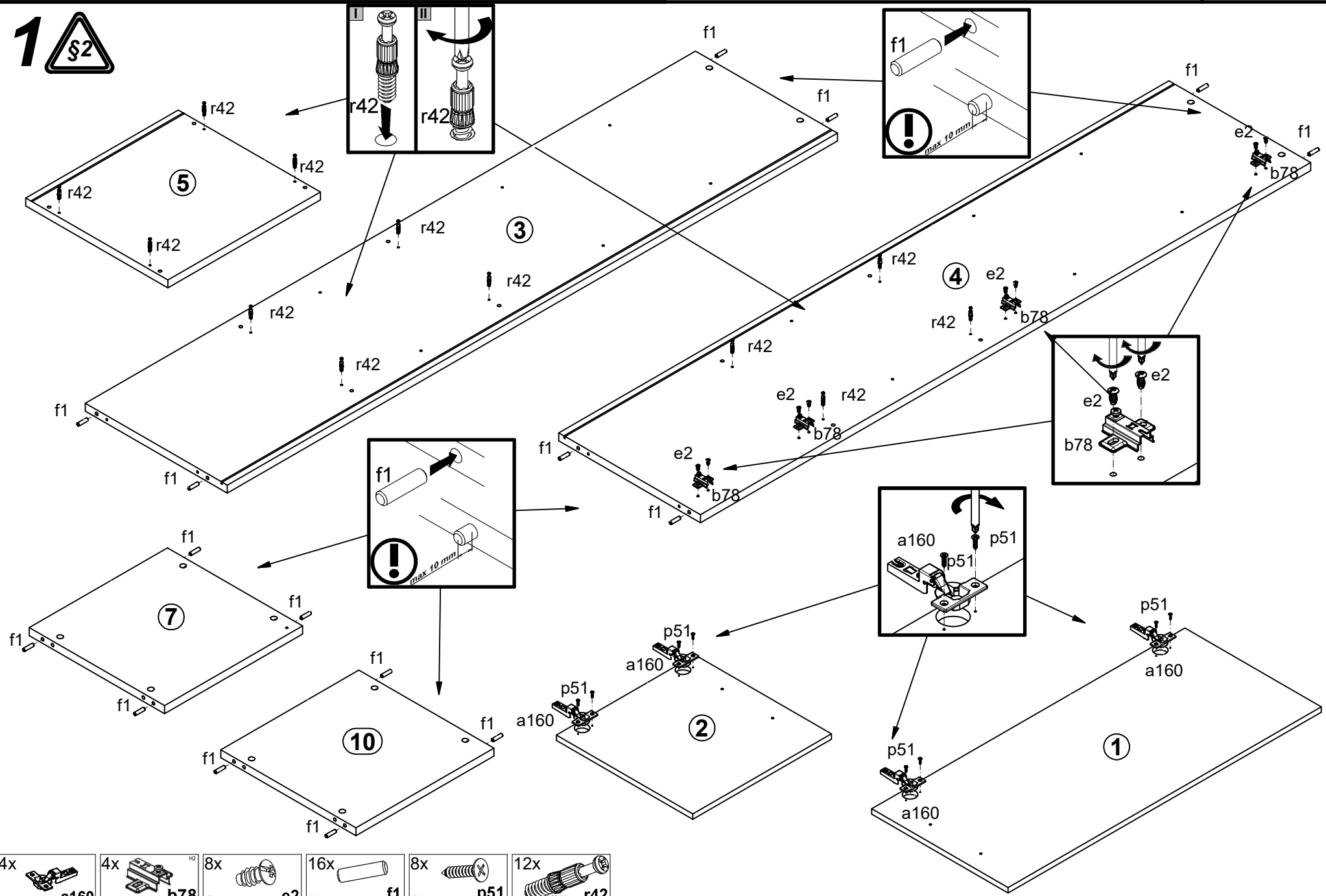

A	B	C (mm)		D
1	S387-0004	994	433	2/2
2	S387-0005	440	433	2/2
3	S387-1004	1936	450	1/2
4	S387-1005	1936	450	1/2
5	S387-2003	484	451	2/2
6	S387-2004	484	451	2/2
7	S387-3005	438	429	2/2
8	S387-3006	437	424	2/2
9	S387-3007	437	412	2/2
10	S387-3012	438	429	2/2
11	S387-9003	1946	448	1/2





- 4x  a160
- 4x  b78
- 8x  e2
Ø6.3x13 mm
- 16x  f1
Ø8x30 mm
- 8x  p51
Ø3.5x15 mm
- 12x  r42
20/11

2 

I

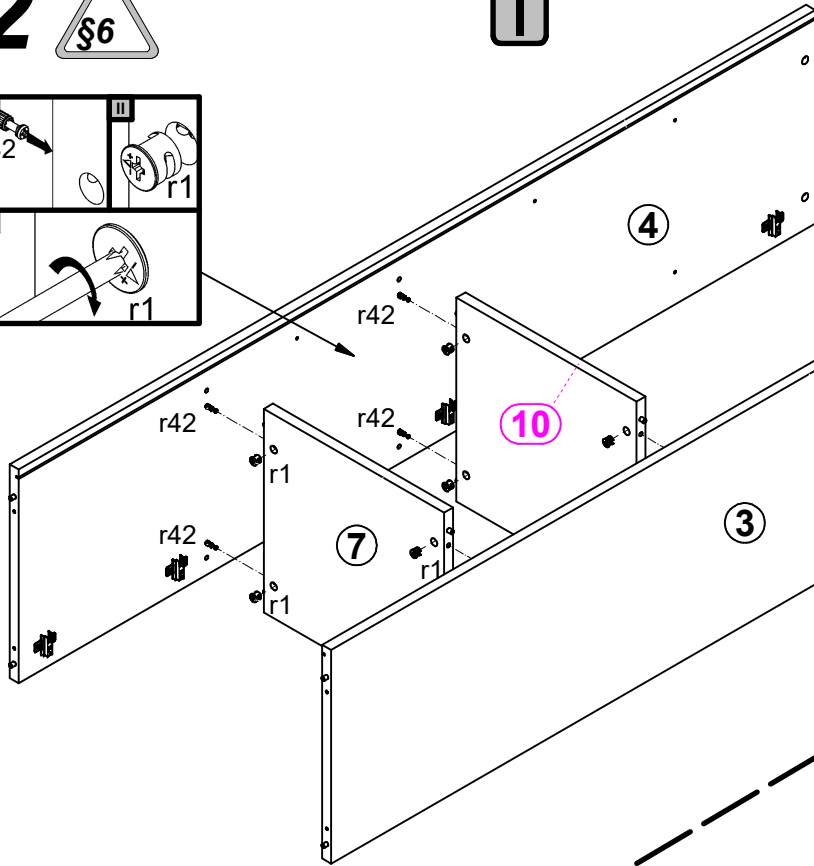
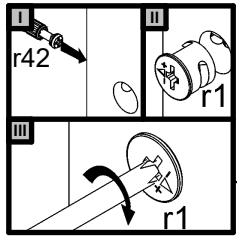

II

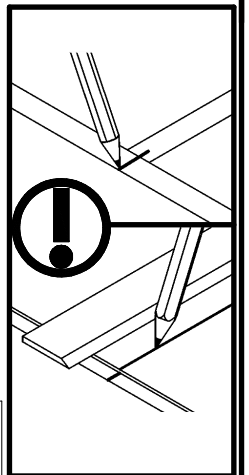
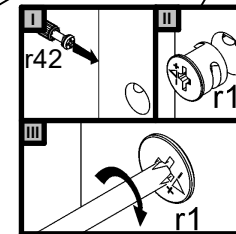
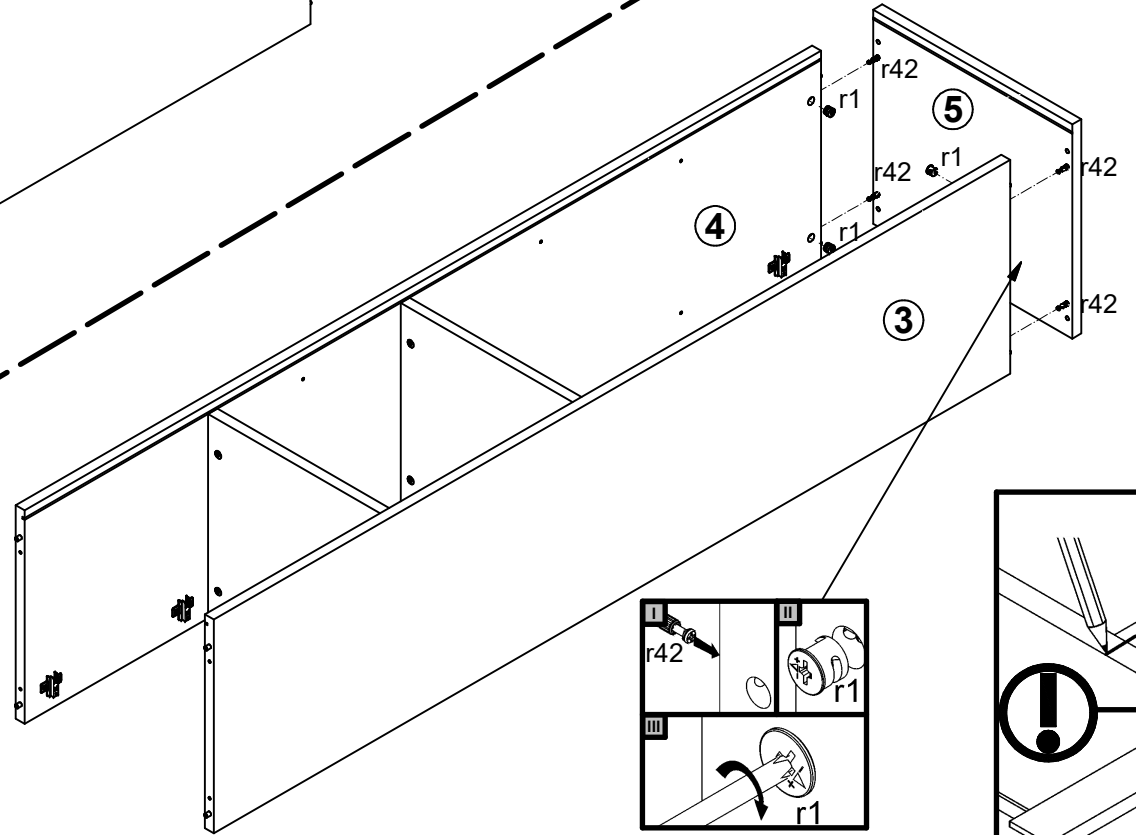

8x  r1
Ø15x12 mm #16





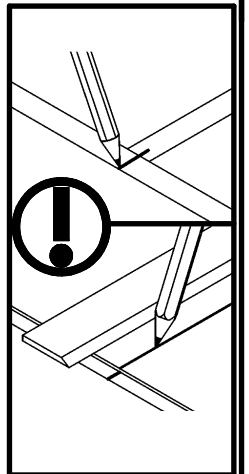
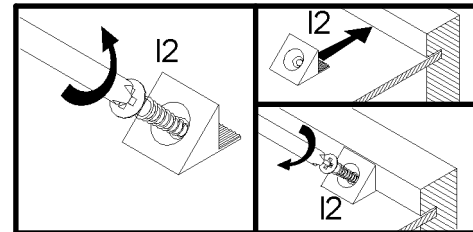
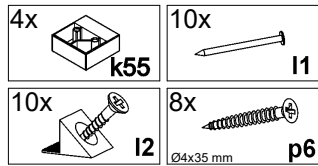
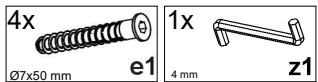
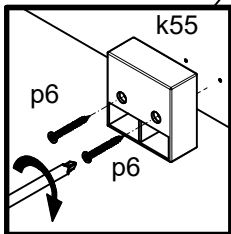
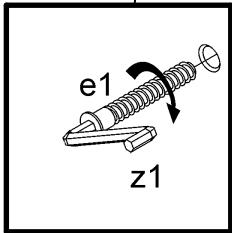
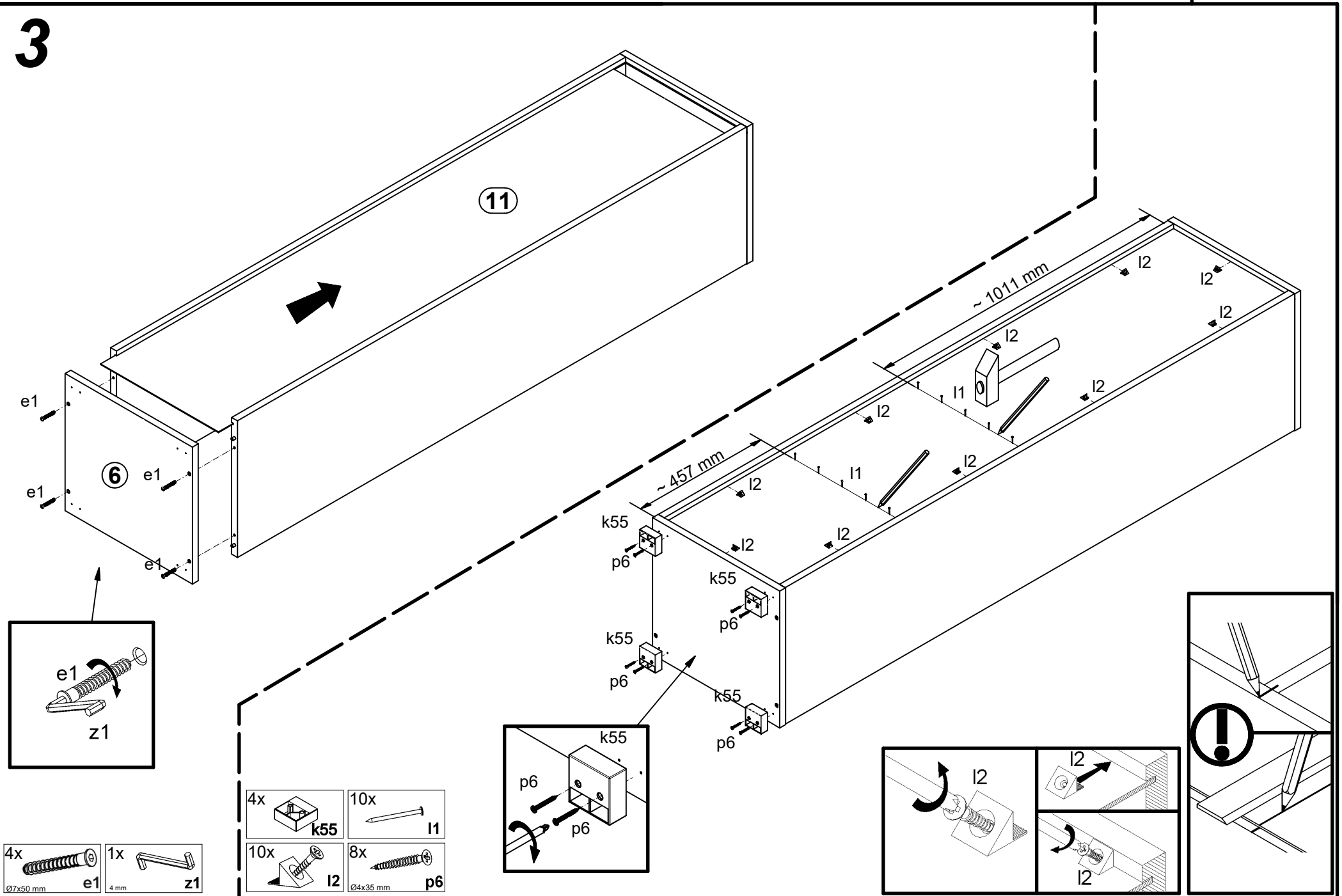

4x  r1
Ø15x12 mm #16

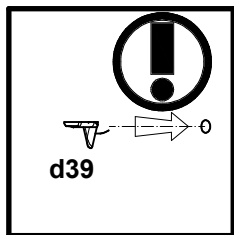
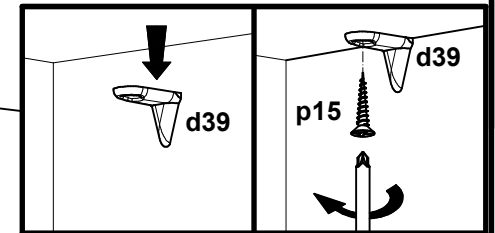
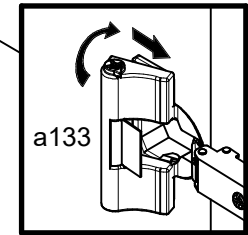
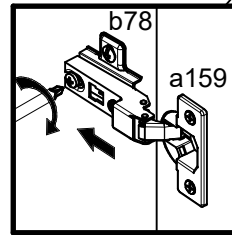
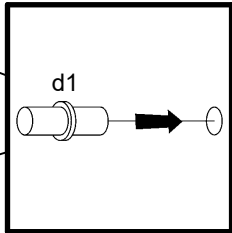
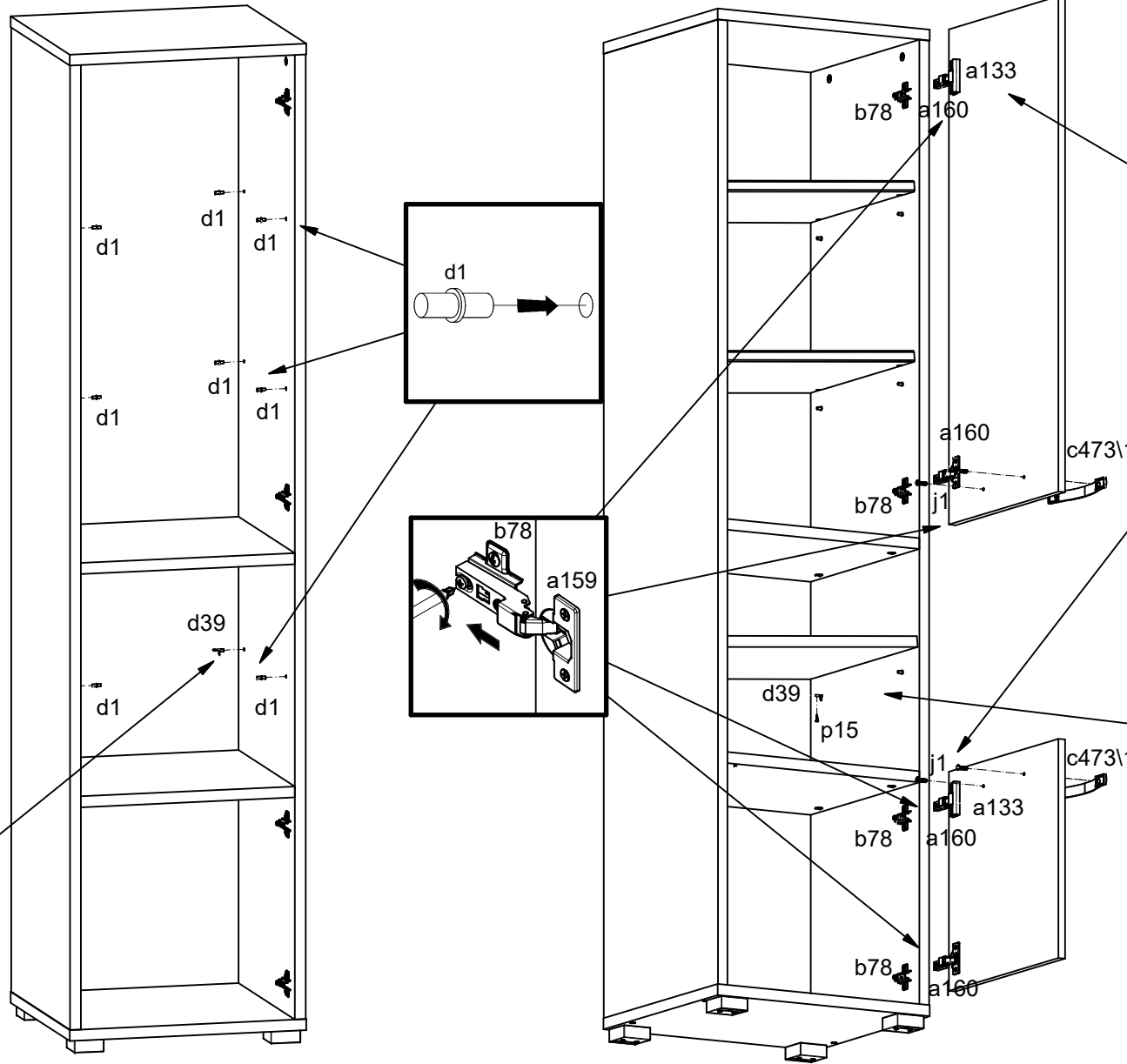
3







4

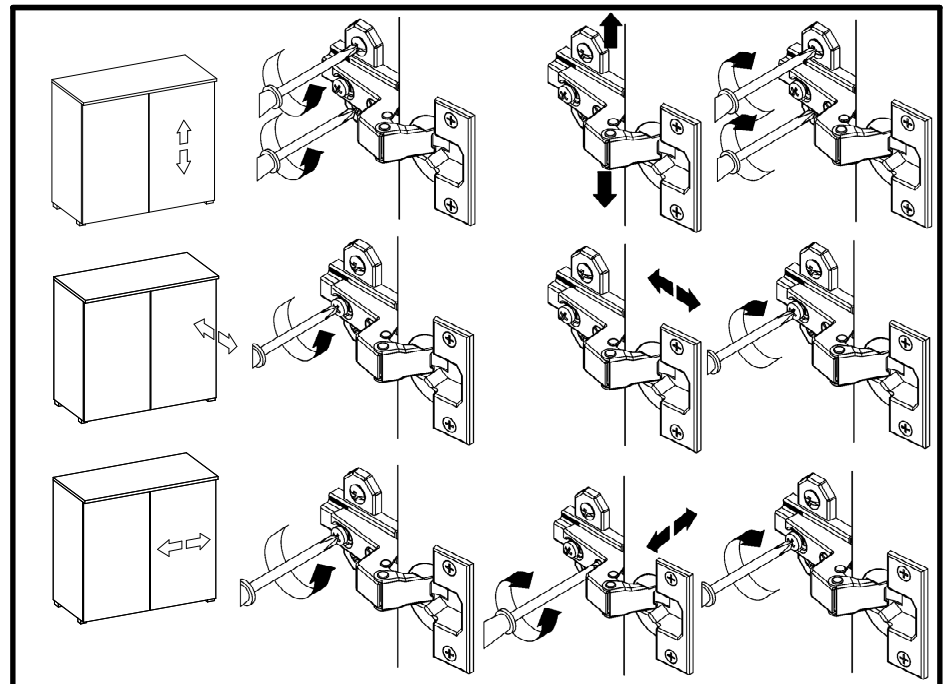
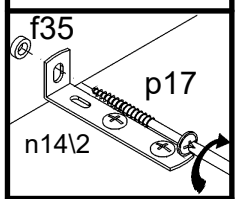
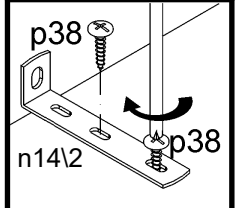
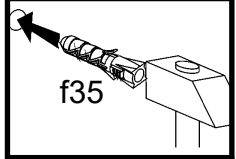
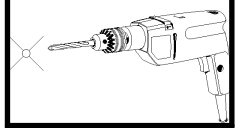
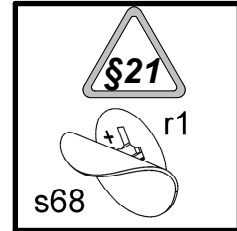
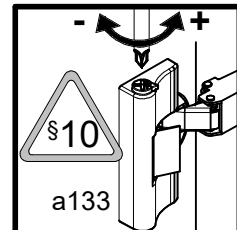
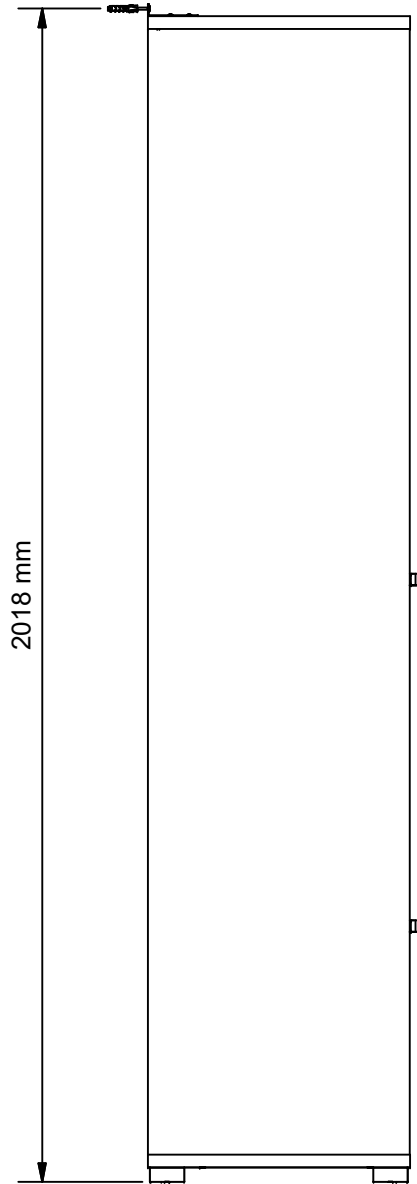
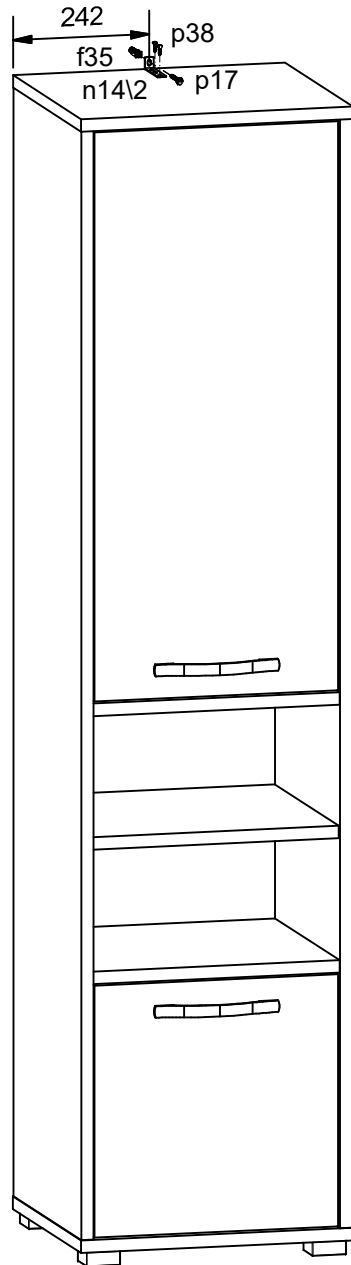

2x  a133	2x  c473\1
10x  Ø5x17 mm d1	2x  Ø2,5x13 mm d39
4x  M4x20 mm j1	2x  Ø2,5x13 mm p15

5

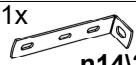
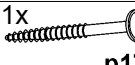
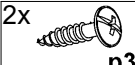

- 1x  f35
- 1x  n14\2
- 1x  p17
- 2x  p38
- 4x  s68