

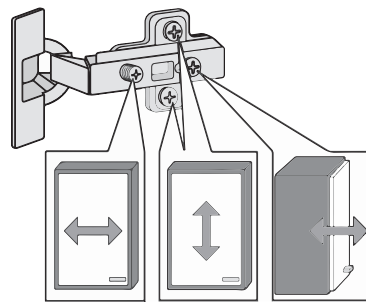

88084.531



3D-Effekt



1 4 x 2802	2 4 x 2801	gedämpft 3 3 x 1506	ungedämpft 4 3 x 1507	5 6 x 1614
6 3,5 x 15 26 x 2804	7 8 x 30 16 x 2861	8 4 x 30 4 x 2812	9 5,8 x 55 2 x 2840	10 8 x 30 2 x 2842
11 2 x 2843	12 6 x 2865	13 1 x 2863	14 24 x 2819	15 3 x 15 6 x 2803
16 3,5 x 17 20 x 2832	17 6 x 2552	18 1 x 2	19 2 x	20 1 x 4 x
21 3 x 1098				



Das beigefügte Wandbefestigungsmaterial (Dübel und Schrauben) eignet sich nur für festes Mauerwerk (z.B.: Beton- oder Ziegelwände). Für andere Wandaufbauten sind eventuell Spezialdübel und andere Schrauben notwendig. Ziehen Sie gegebenenfalls eine Fachkraft zu Rate.

De begeleidende wandmontage hardware (pluggen en schroeven) is alleen geschikt voor massief metselwerk (bijvoorbeeld beton of bakstenen muren). Voor andere muur structuren zijn eventueel bijzondere ankerbouten en andere noodzakelijke. Draai indien nodig, een deskundige.

Приложенный материал для крепления к стене (дюбели и винты) пригоден только для жестких кладок (например, бетонные или кирпичные стены). Для других настенных конструкций необходимы смотря по обстоятельствам специальные дюбели и другие винты. При необходимости проконсультируйтесь у специалиста.

Le mur d'accompagnement matériel de montage (chevilles et les vis) ne convient que pour la maçonnerie solide (par exemple en béton ou des murs de briques). Pour les structures de mur d'autres sont peut-être spéciale boulons d'ancrage et d'autres nécessaires. Serrer le cas échéant, un expert.

Załączony materiał do mocowania do ściany (kolki rozprężne i wkręty) nadaje się tylko do ścian murowanych (np. z betonu lub cegieł). Do ścian wykonanych w innych technologiach konieczne być mogą specjalne kolki rozprężne i inne wkręty. W razie potrzeby skorzystaj z fachowej pomocy

Il muro di accompagnamento hardware di montaggio (tasselli e viti) è adatto solo per muratura piena (ad esempio calcestruzzo o muratura). Per le altre strutture murarie sono forse speciali bulloni di ancoraggio e necessari di altri. Serrare se necessario, un esperto.

The accompanying wall mounting hardware (anchors and screws) is suitable only for solid masonry (eg concrete or brick walls). For other wall structures are possibly special anchor bolts and other necessary. Tighten if necessary, an expert.

Ekteki duvara sabit montaj malzemeleri (dübel ve vidalar), sadece sağlam duvarlar için (örnek: beton veya tuğla) elverişlidir. Başka duvarlar için özel dübeller ve farklı vidalar gerekebilir. Gerekliğinde bir uzmana danışınız.

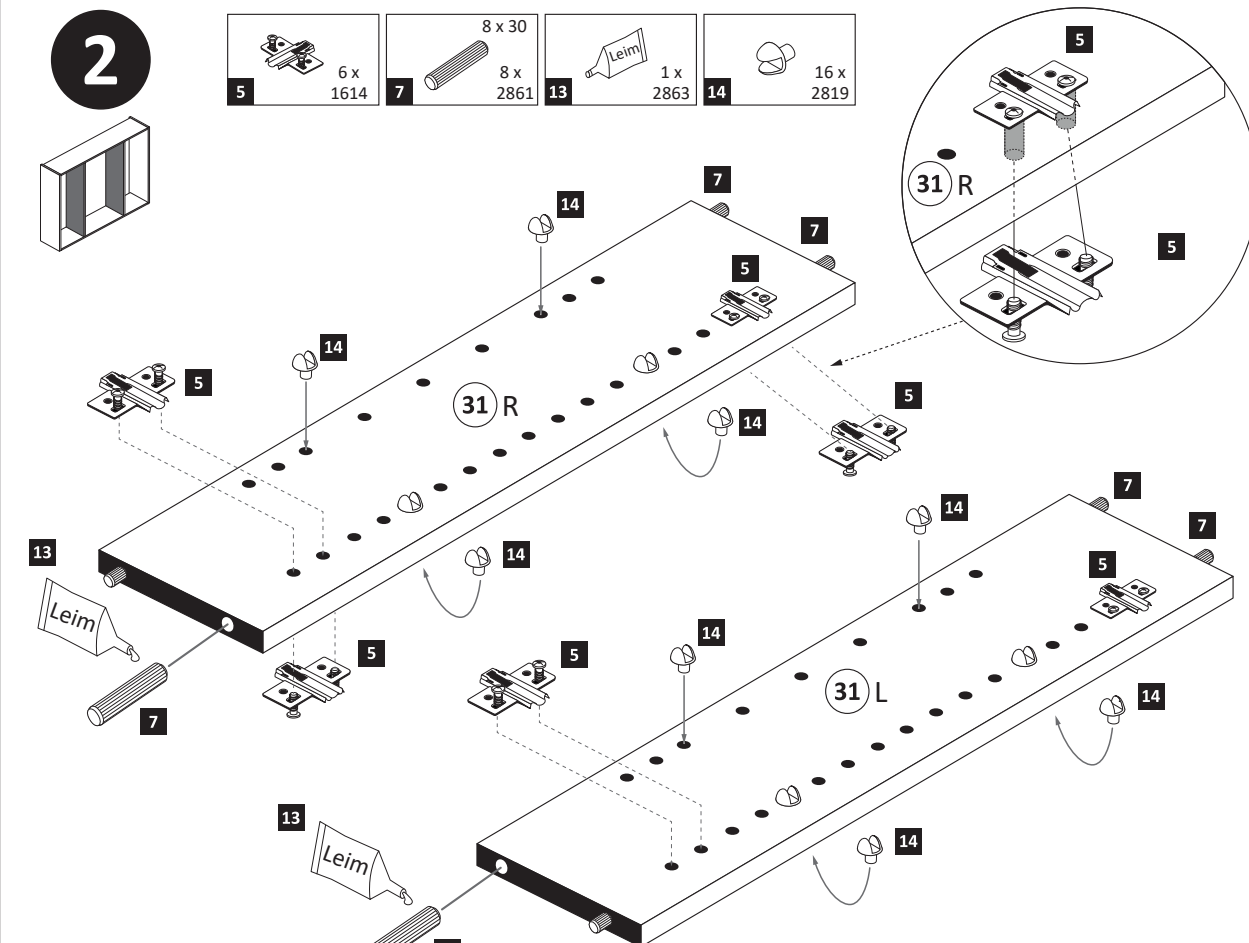
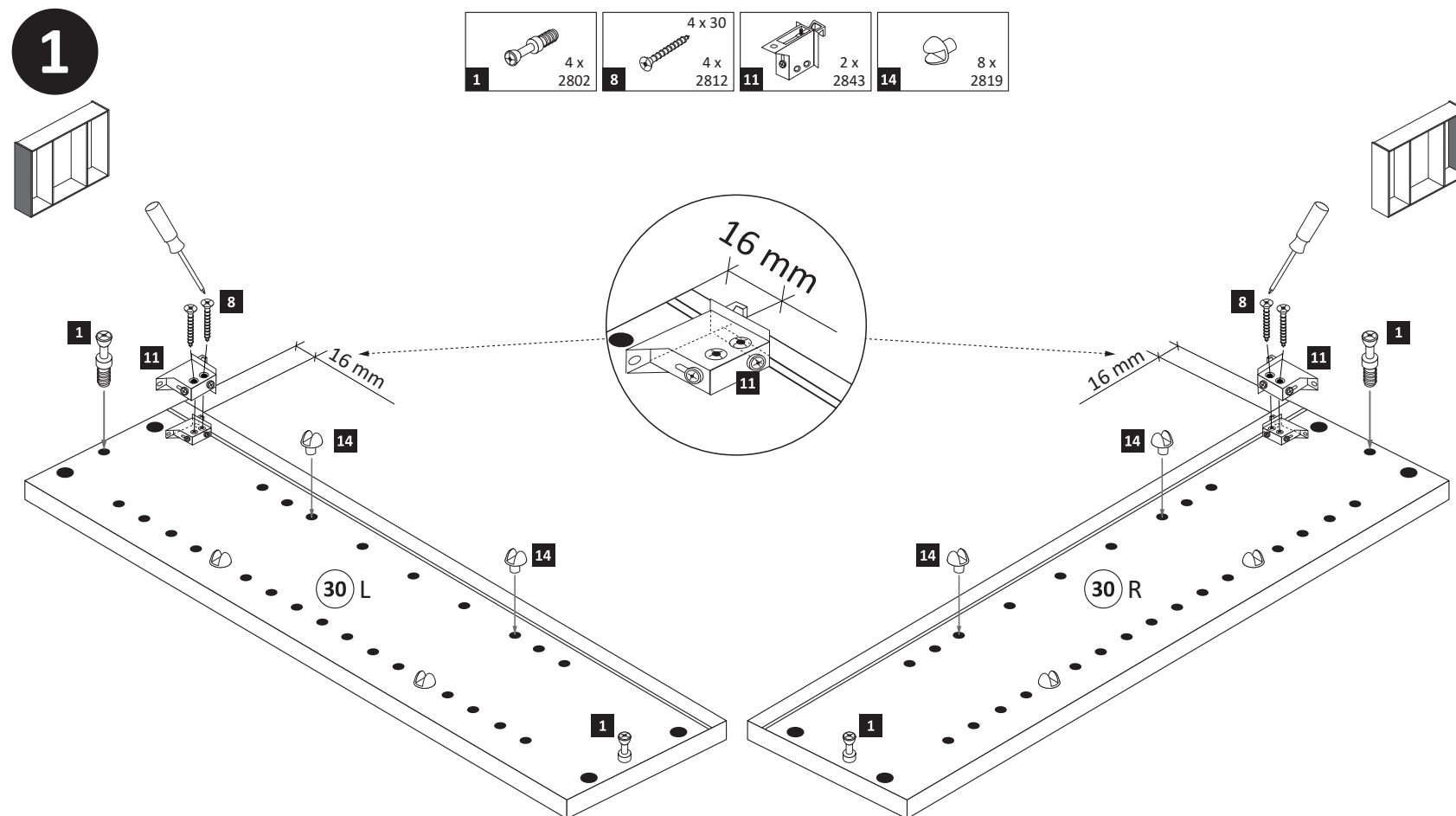
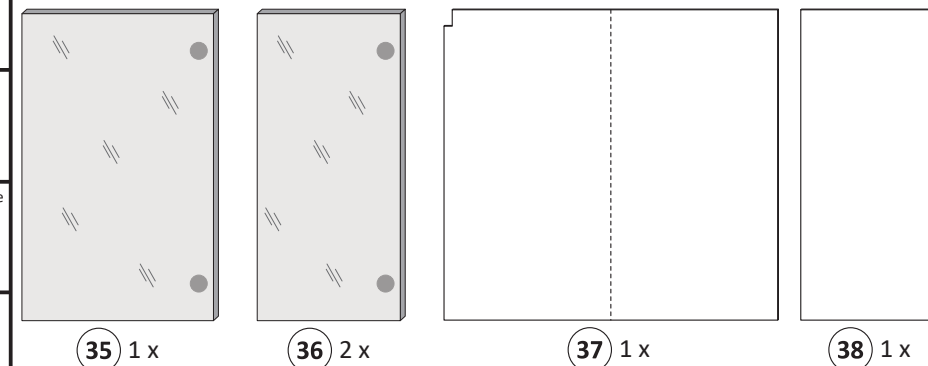
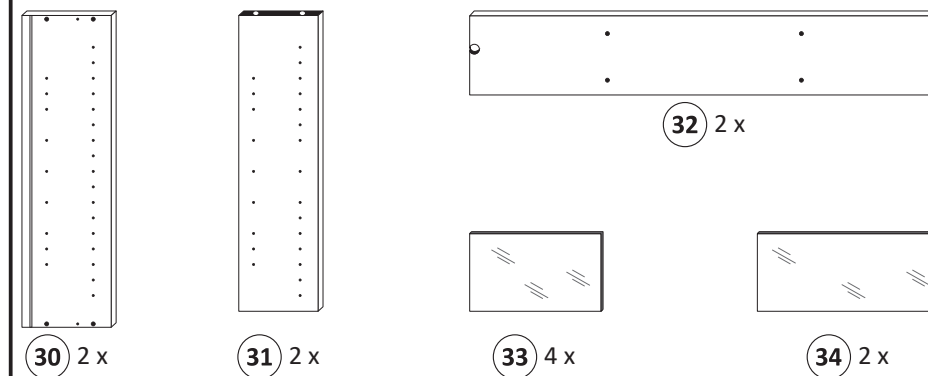

3

- 2 4 x 2801
- 7 8 x 30 2861
- 13 1 x 2863

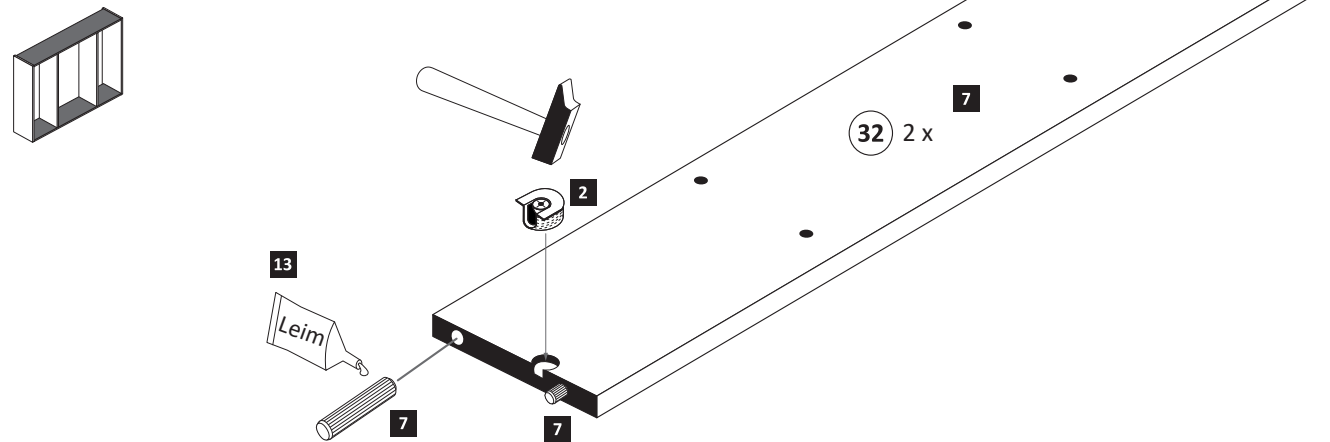

4

- 6 3,5 x 15 2804

- 13 1 x 2863
- 20 min.
- D Leim
 - GB Glue
 - NL Lijm
 - PL Klej
 - TR Tutkal
 - F Colle
 - I Colla

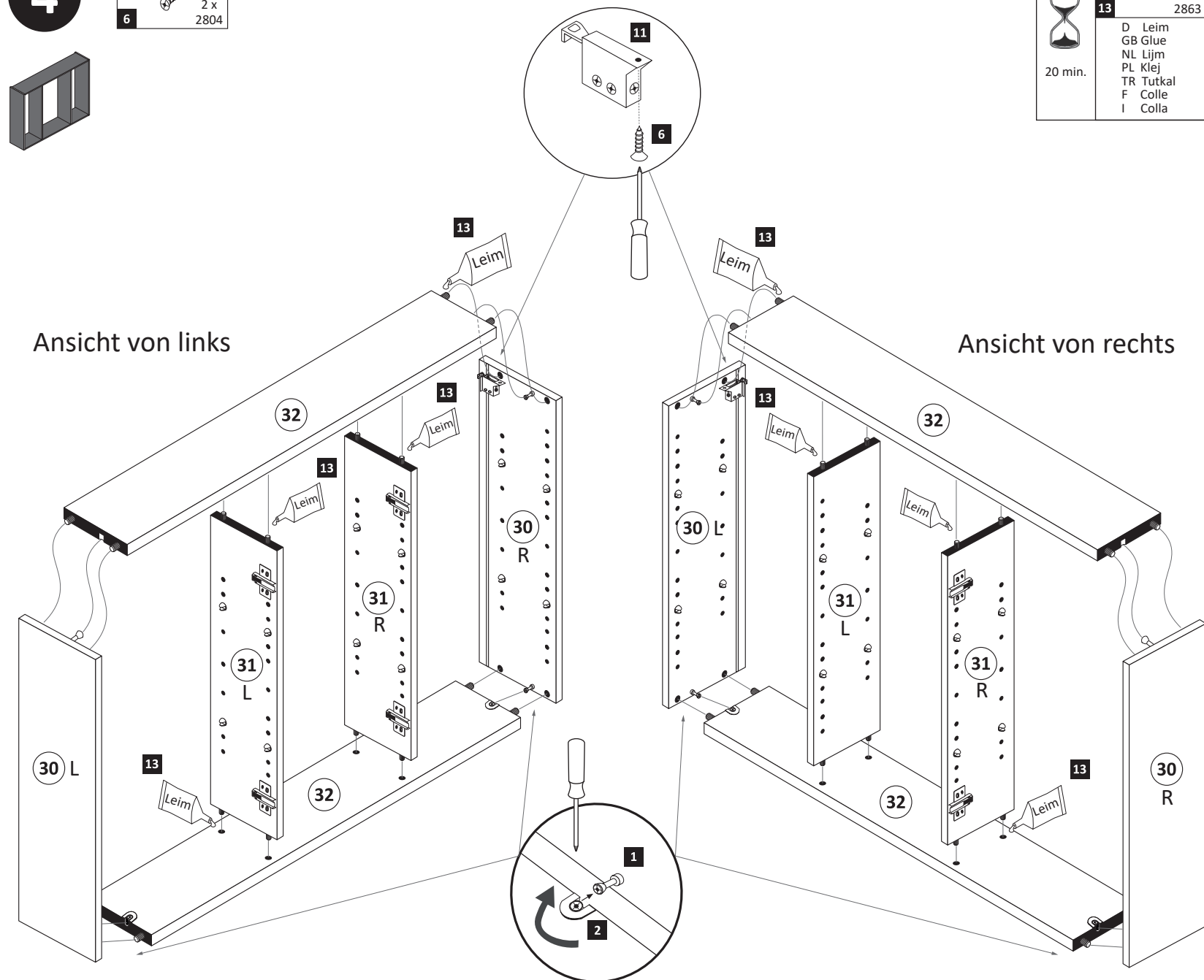

5

Bitte nur eine Variante auswählen und den entsprechenden Ausschnitt in einer Größe von maximal Trafobreite wie Trafohöhe - 10 mm aussägen. Trafomontage wird im Schritt 7 durchgeführt.

Variante 1: Trafomontage unten

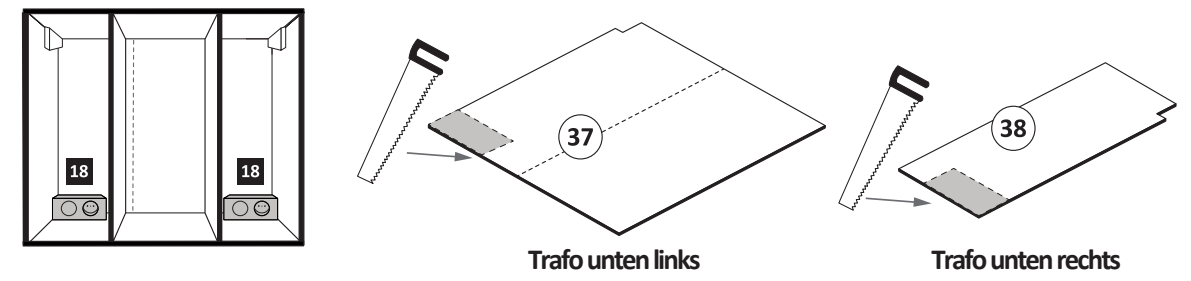

Variante 2: Trafomontage oben

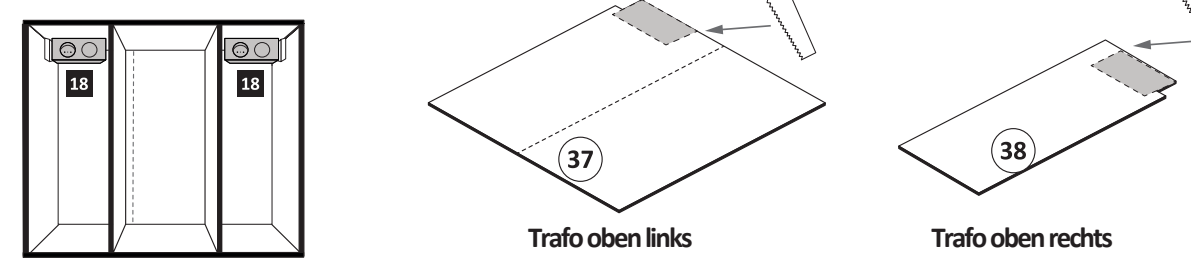

6

- 16 3,5 x 17 2832
- 17 6 x 2552

ACHTUNG !
Folgende Montageschritte mit dem Beispiel „Trafomontage Variante unten links“ !

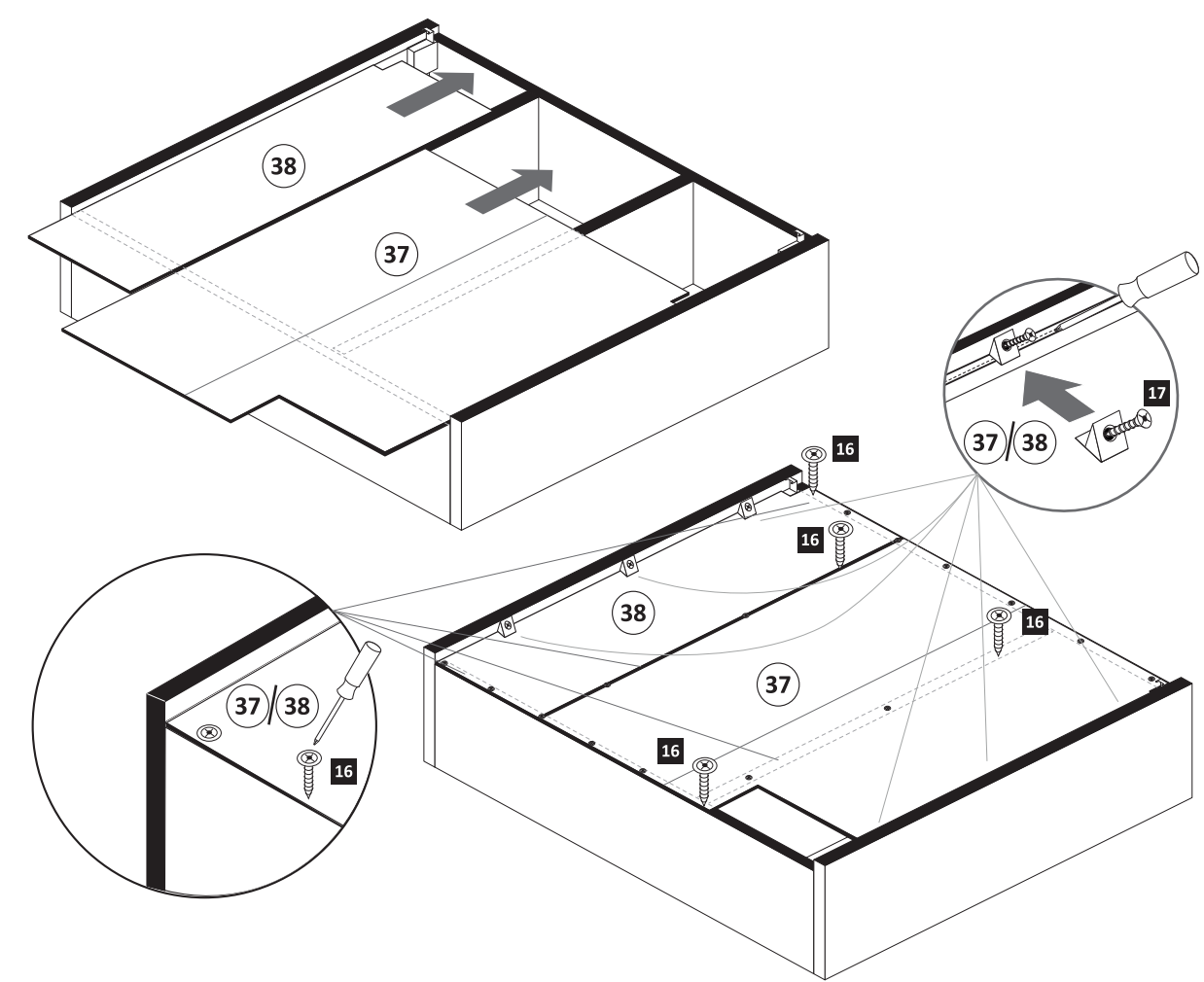

7

18 1x 2x

Achtung !!
Die Distanzhülsen sind optional im Lieferumfang.
Nur bei Bedarf nutzen.

8

33 34 33 34 33

10

35 36 36

Scharniermontage

1. 2.

Scharnier lösen 2. 1. (drücken)

9

gedämpft 3 x 1506 3
ungedämpft 3 x 1507 4
3,5 x 15 12 x 2804 6
6 x 2865 12

3 4 6 12 35 36 2 x 12

Scharnieransichten von unten

3 4

11

3 x 15 15 6 x 2803 21 3 x 1098 21

15 21 3 x 1098 21

8 mm 5 mm

Unten

12

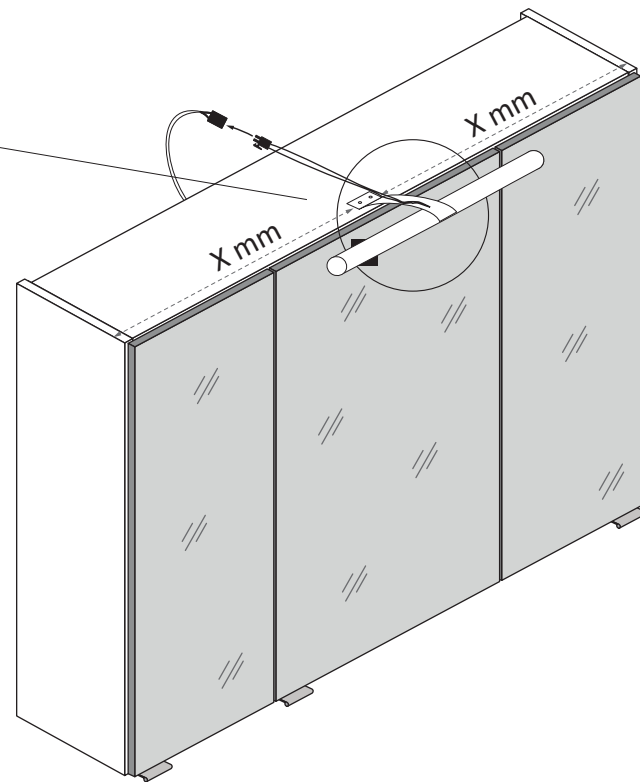
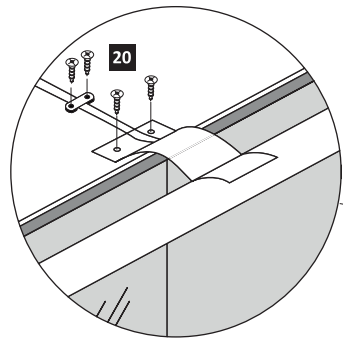
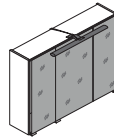
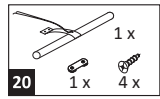

13

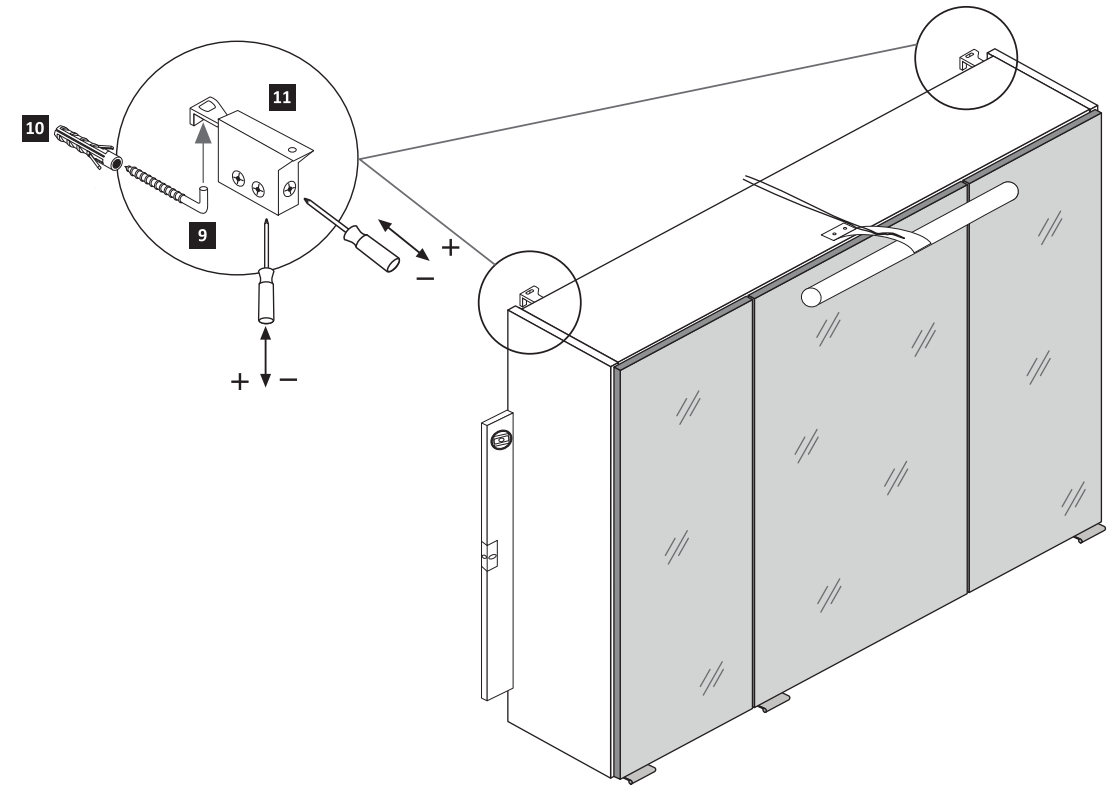
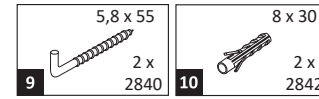

14

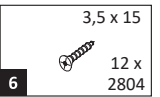

1. Türen einstellen.

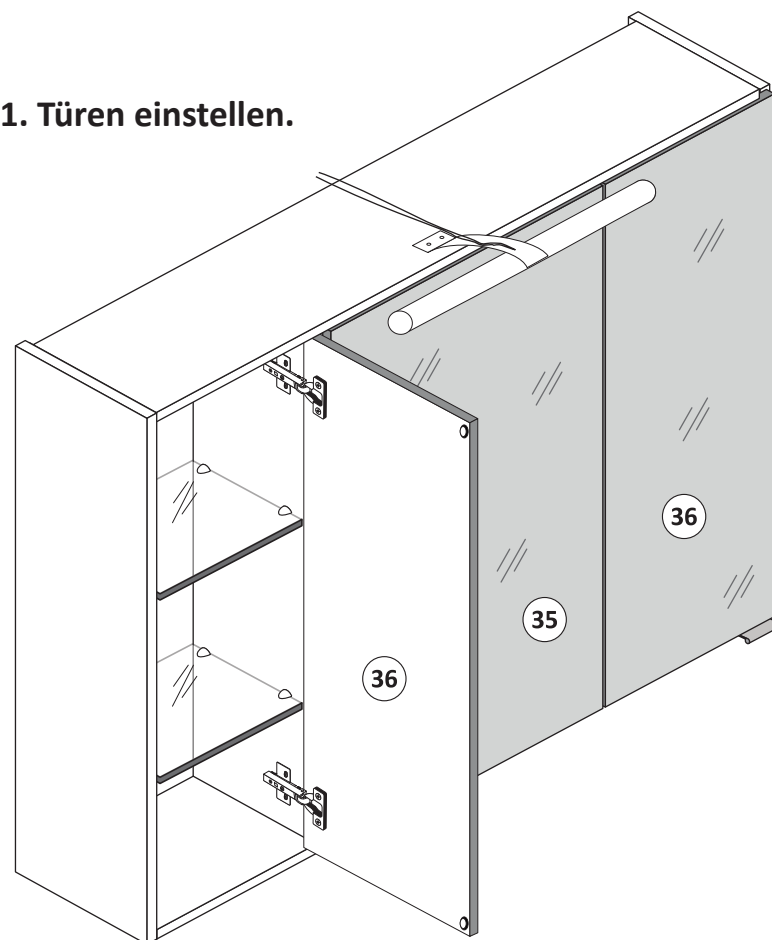
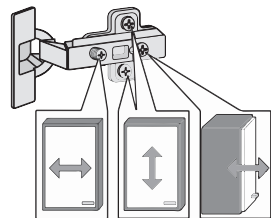

Achtung !!
Aus Sicherheitsgründen ist die Montage der Sicherungsschrauben zwingend notwendig. Nachdem montieren der Sicherungsschrauben ist die Höheneinstellung der Türen nicht mehr möglich!

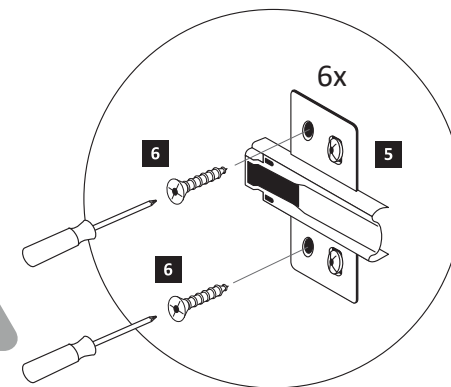

2. Sicherungsschrauben montieren.

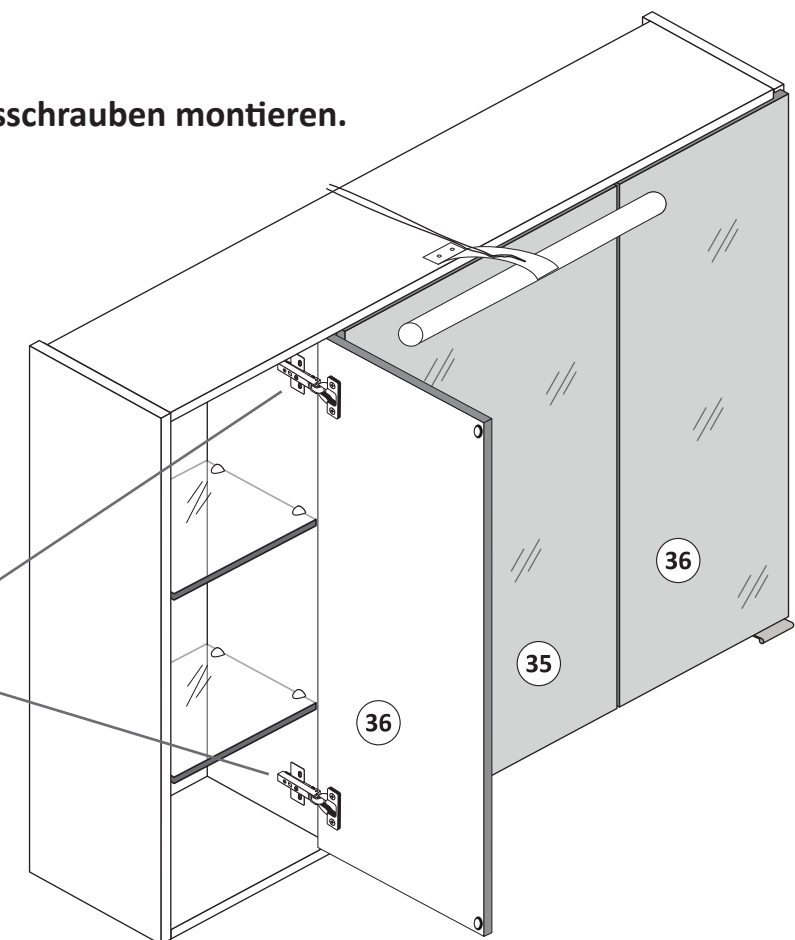



88084.531

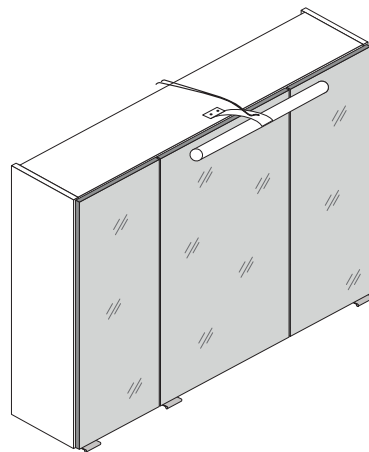

3D-Effekt

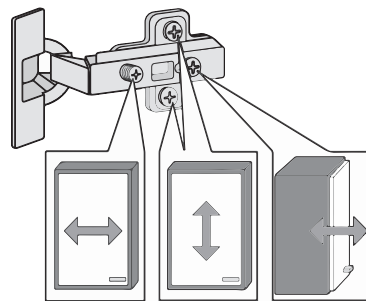
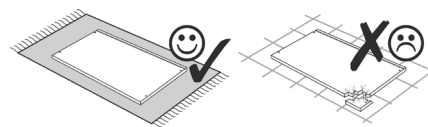
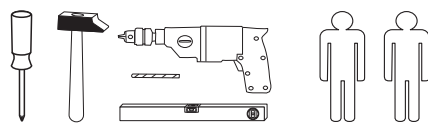
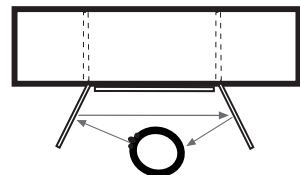

1 4 x 2802	2 4 x 2801	gedämpft 3 x 1506	ungedämpft 3 x 1507	6 x 1614
3,5 x 15 26 x 2804	8 x 30 16 x 2861	4 x 30 4 x 2812	5,8 x 55 2 x 2840	8 x 30 2 x 2842
11 2 x 2843	12 6 x 2865	Leim 1 x 2863	14 24 x 2819	15 3 x 15 6 x 2803
3,5 x 17 20 x 2832	17 6 x 2552	18 1 x 2 x	20 1 x 4 x	3 x 15 6 x 2803
21 3 x 1098				

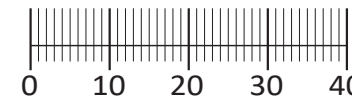

Das beigefügte Wandbefestigungsmaterial (Dübel und Schrauben) eignet sich nur für festes Mauerwerk (z.B.: Beton- oder Ziegelwände). Für andere Wandaufbauten sind eventuell Spezialdübel und andere Schrauben notwendig. Ziehen Sie gegebenenfalls eine Fachkraft zu Rate.

Приложенный материал для крепления к стене (дюбели и винты) пригоден только для жестких кладок (например, бетонные или кирпичные стены). Для других настенных конструкций необходимы смотря по обстоятельствам специальные дюбели и другие винты. При необходимости проконсультируйтесь у специалиста.

Załączony materiał do mocowania do ściany (kolki rozprężne i wkręty) nadaje się tylko do ścian murowanych (np. z betonu lub cegieł). Do ścian wykonanych w innych technologiach konieczne być mogą specjalne kolki rozprężne i inne wkręty. W razie potrzeby skorzystaj z fachowej pomocy.

The accompanying wall mounting hardware (anchors and screws) is suitable only for solid masonry (eg concrete or brick walls). For other wall structures are possibly special anchor bolts and other necessary. Tighten if necessary, an expert.

De begeleidende wandmontage hardware (pluggen en schroeven) is alleen geschikt voor massief metselwerk (bijvoorbeeld beton of bakstenen muren). Voor andere muur structuren zijn eventueel bijzondere ankerbouten en andere noodzakelijke. Draai indien nodig, een deskundige.

Le mur d'accompagnement matériel de montage (chevilles et les vis) ne convient que pour la maçonnerie solide (par exemple en béton ou des murs de briques). Pour les structures de mur d'autres sont peut-être spéciale boulons d'ancrage et d'autres nécessaires. Serrer le cas échéant, un expert.

Il muro di accompagnamento hardware di montaggio (tasselli e viti) è'e adatto solo per muratura piena (ad esempio calcestruzzo o muratura). Per le altre strutture murarie sono forse speciali bulloni di ancoraggio e necessari di altri. Serrare se necessario, un esperto.

Ekteki duvara sabit montaj malzemeleri (dübel ve vidalar), sadece sağlam duvarlar için (örnek: beton veya tuğla) elverişlidir. Başka duvarlar için özel dübeller ve farklı vidalar gerekebilir. Gerekliğinde bir uzmana danışınız.

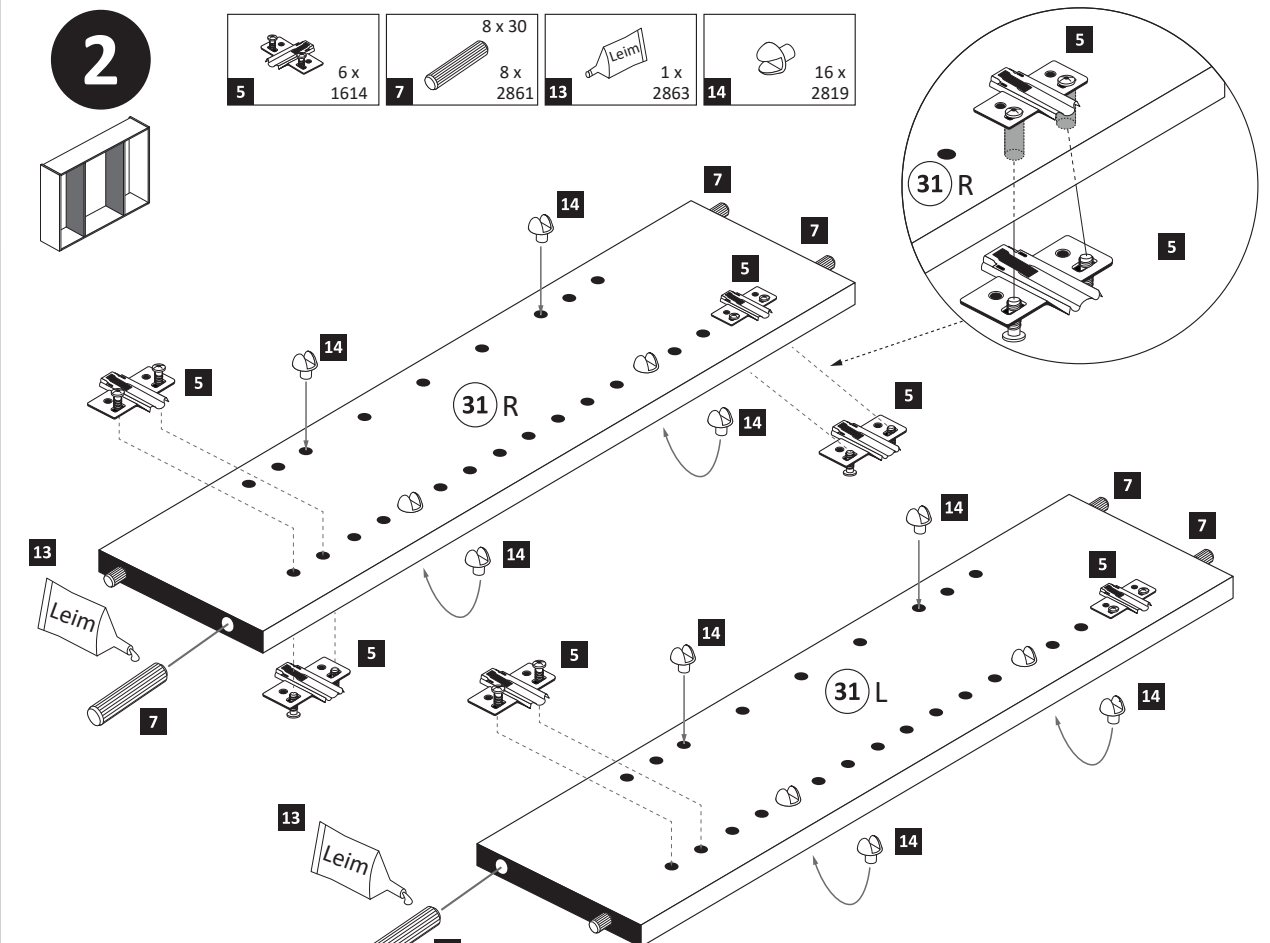
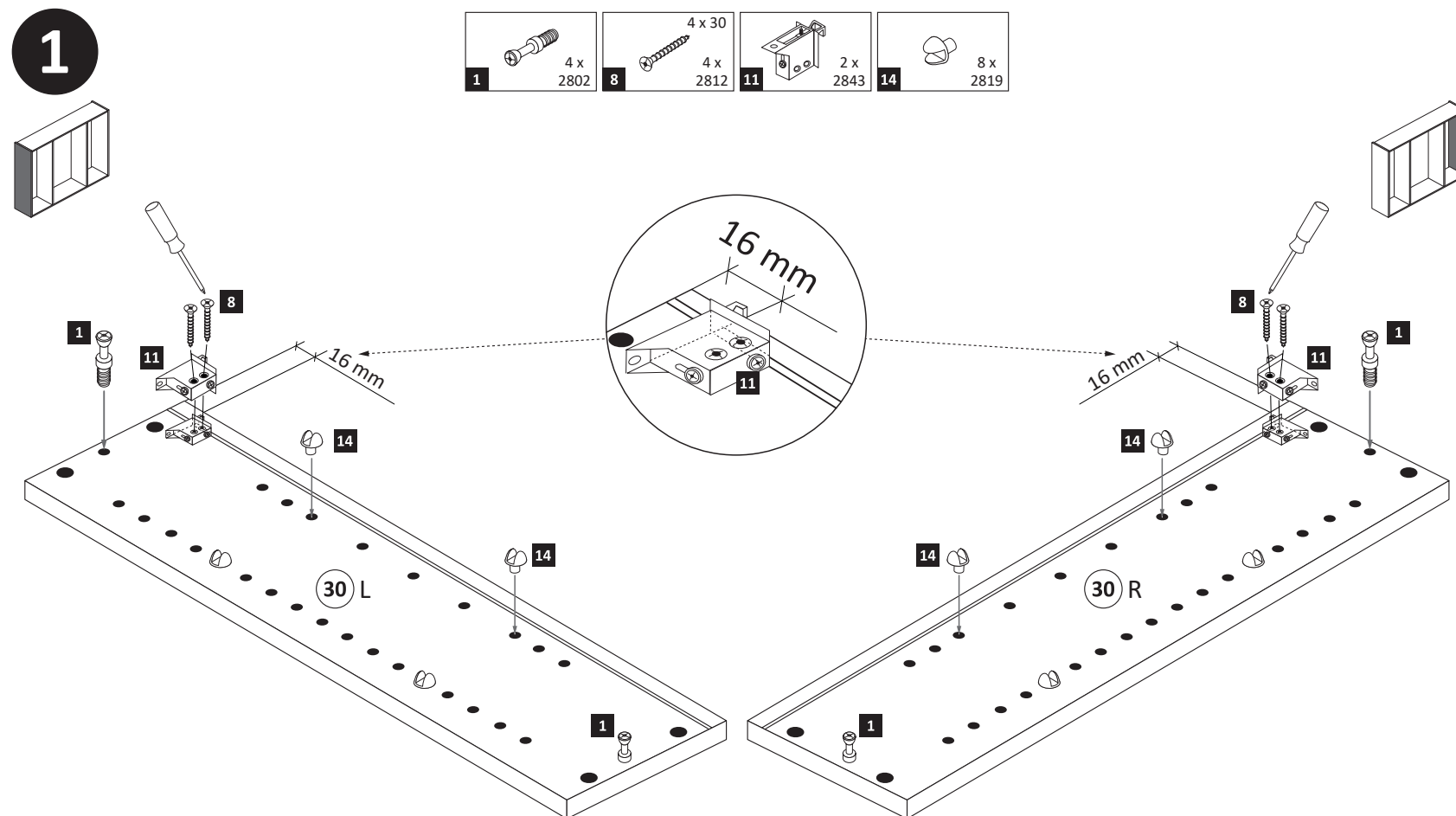
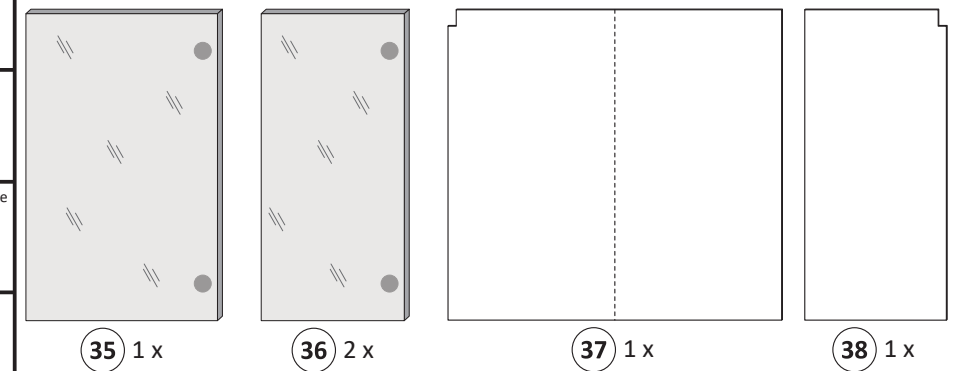
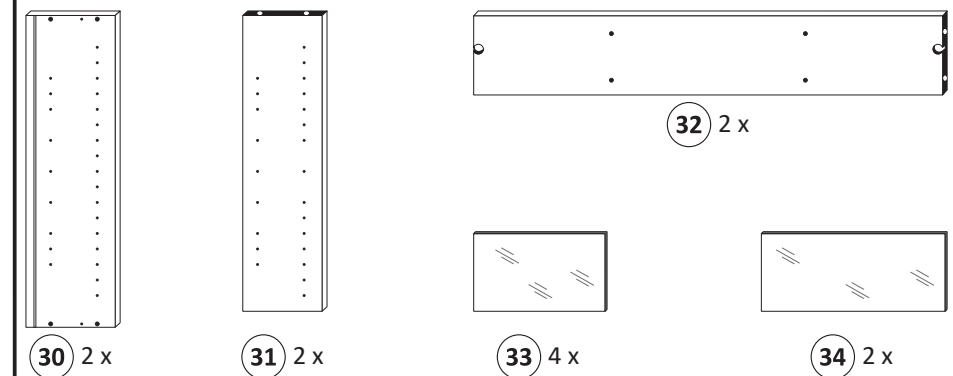

3

- 2** 4 x 2801
- 7** 8 x 30 2861
- 13** 1 x 2863

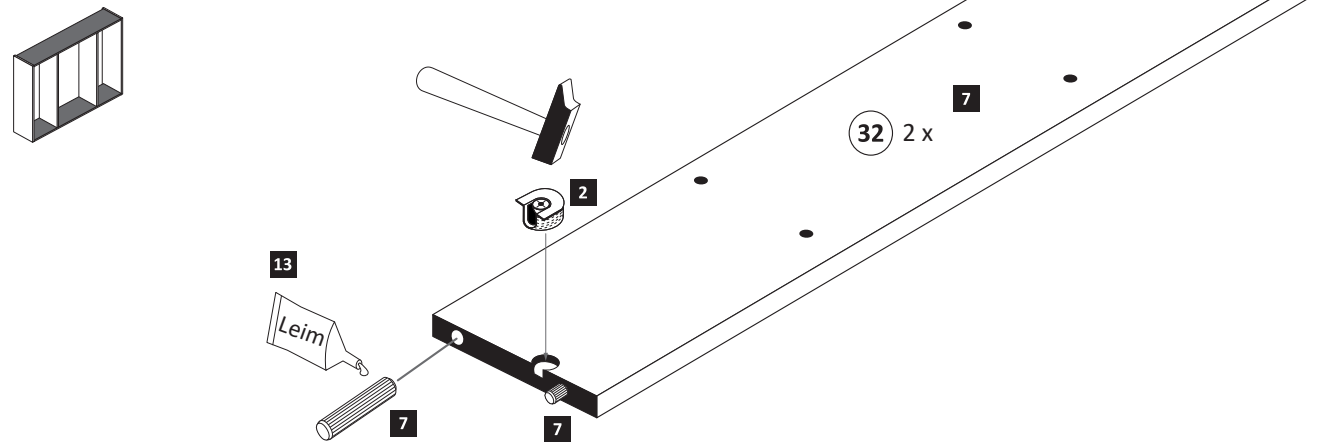

4

- 3,5 x 15
- 6** 2 x 2804

- 13** 1 x 2863
- 20 min.
- D Leim
- GB Glue
- NL Lijm
- PL Klej
- TR Tutkal
- F Colle
- I Colla

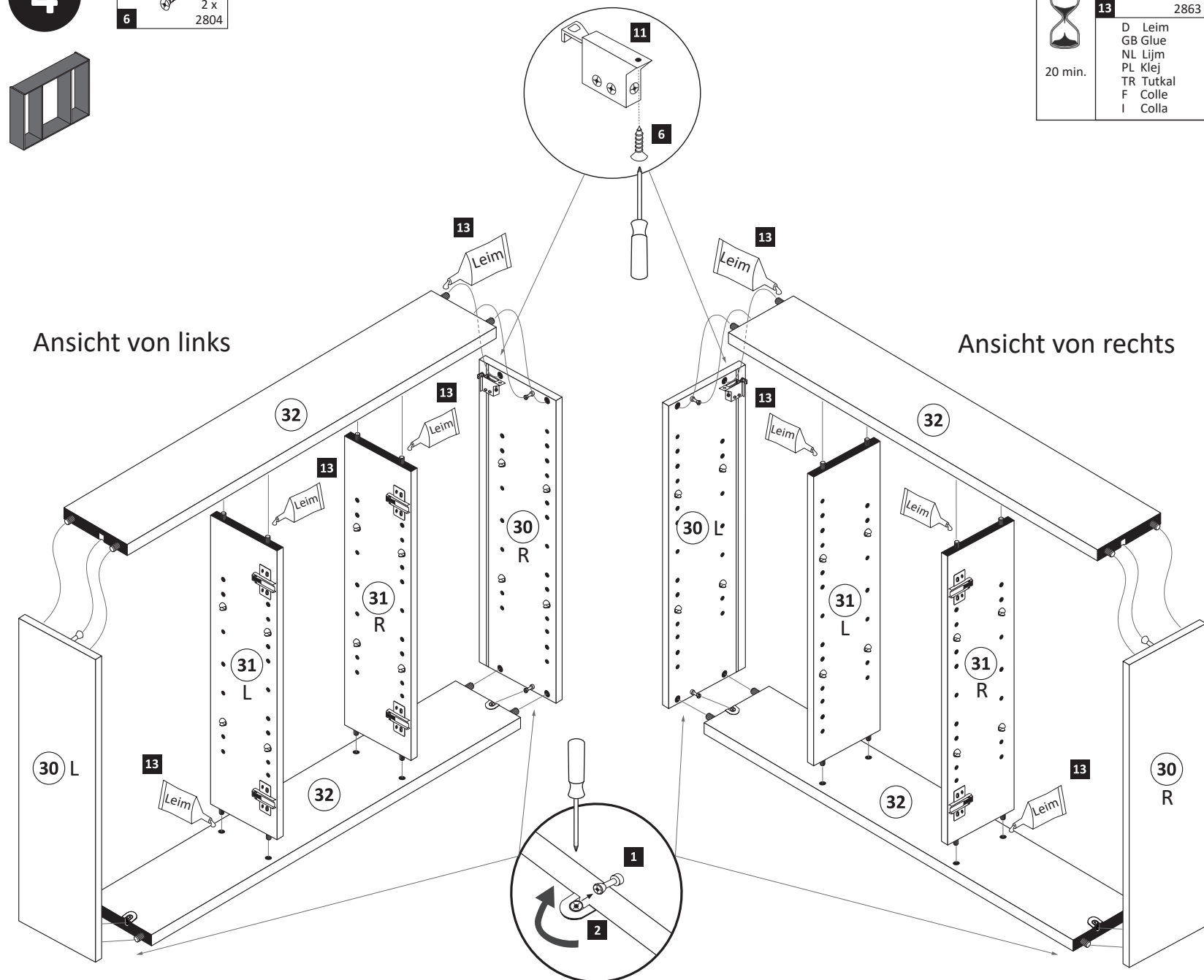

5

Bitte nur eine Variante auswählen und den entsprechenden Ausschnitt in einer Größe von maximal Trafobreite wie Trafohöhe - 10 mm aussägen. Trafomontage wird im Schritt **7** durchgeführt.

Variante 1: Trafomontage unten

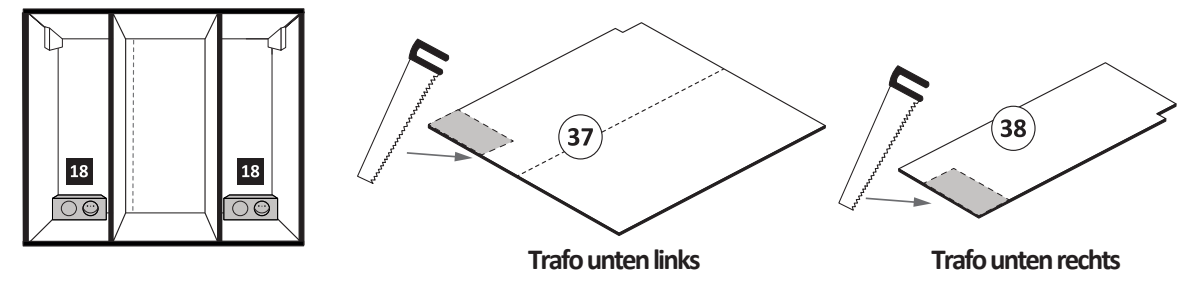

Variante 2: Trafomontage oben

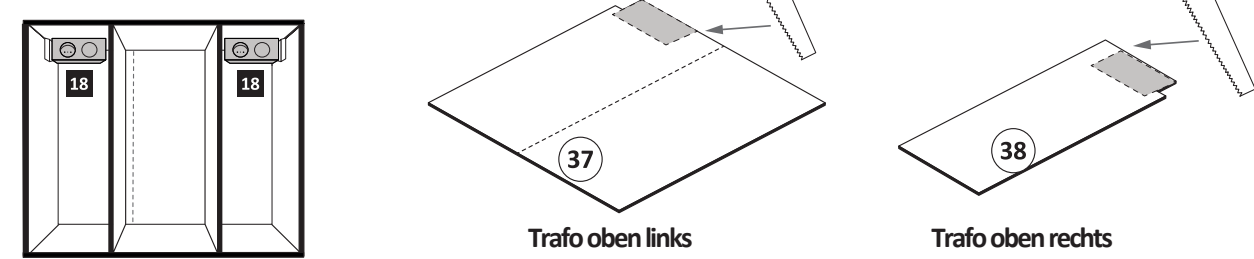

6

- 3,5 x 17
- 16** 20 x 2832
- 17** 6 x 2552

ACHTUNG !
Folgende Montageschritte mit dem Beispiel „Trafomontage Variante unten links“ !

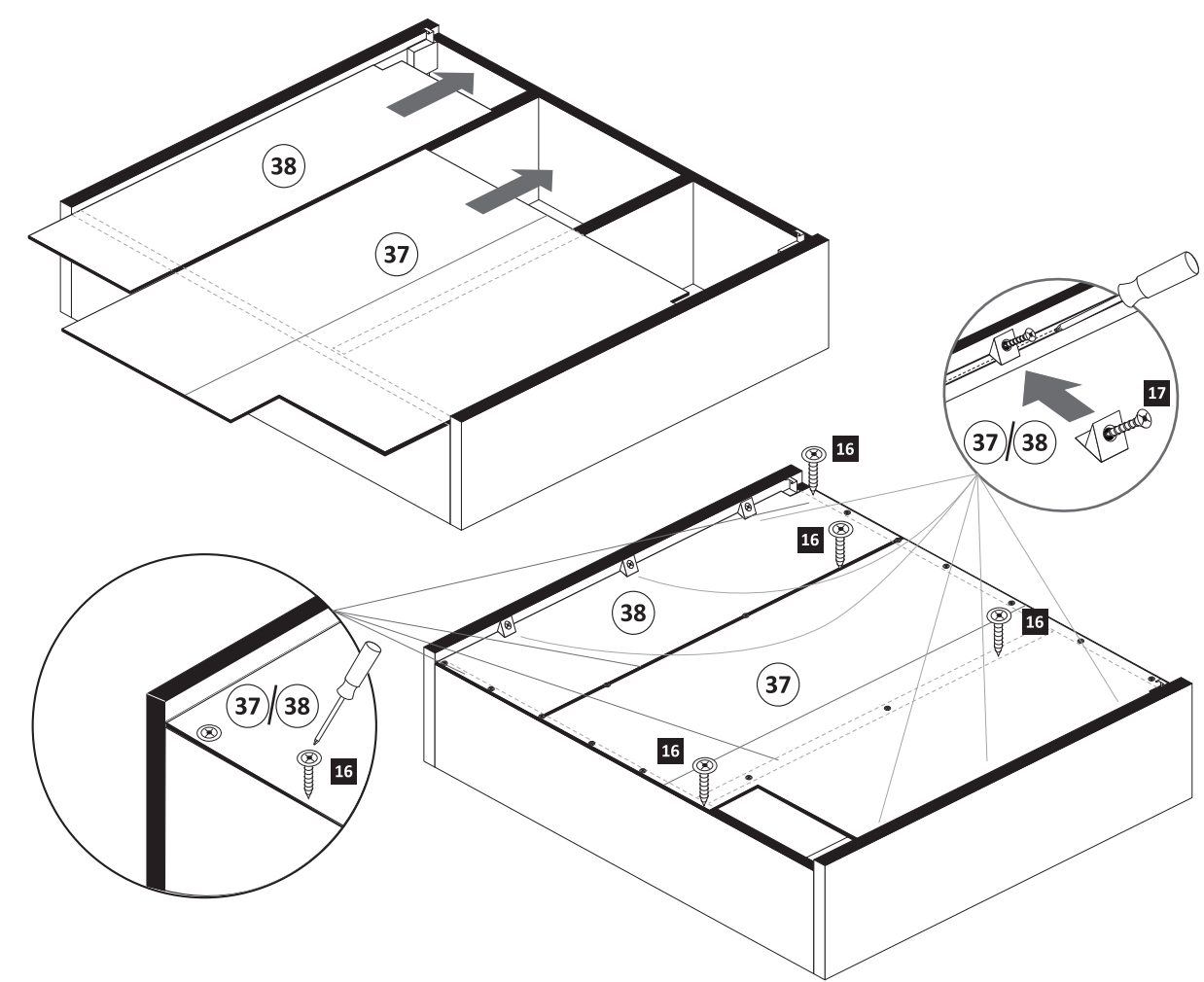

7

18 1x 2x

Achtung !!
Die Distanzhülsen sind optional im Lieferumfang.
Nur bei Bedarf nutzen.

8

33 34 33 34 33

10

35 36 36

Scharniermontage

1. 2.

Scharnier lösen 2. 1. (drücken)

9

gedämpft 3 x 1506 3
ungedämpft 3 x 1507 4
3,5 x 15 12 x 2804 6
6 x 2865 12

3 4 6 12 35 36 2 x 12

Scharnieransichten von unten

11

3 x 15 6 x 2803 21 3 x 1098

15 21 8 mm 5 mm

Unten

12

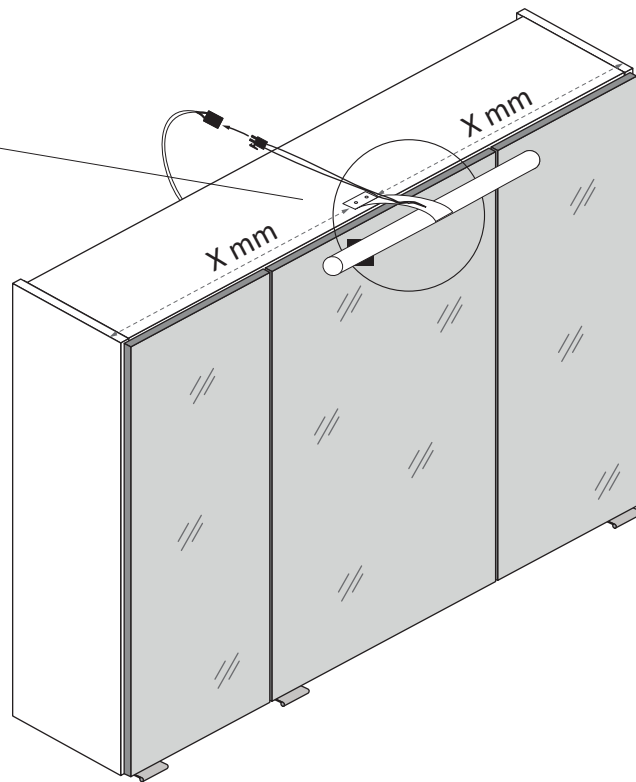
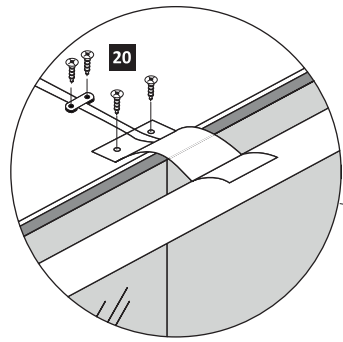
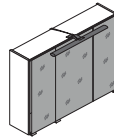
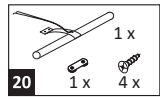

13

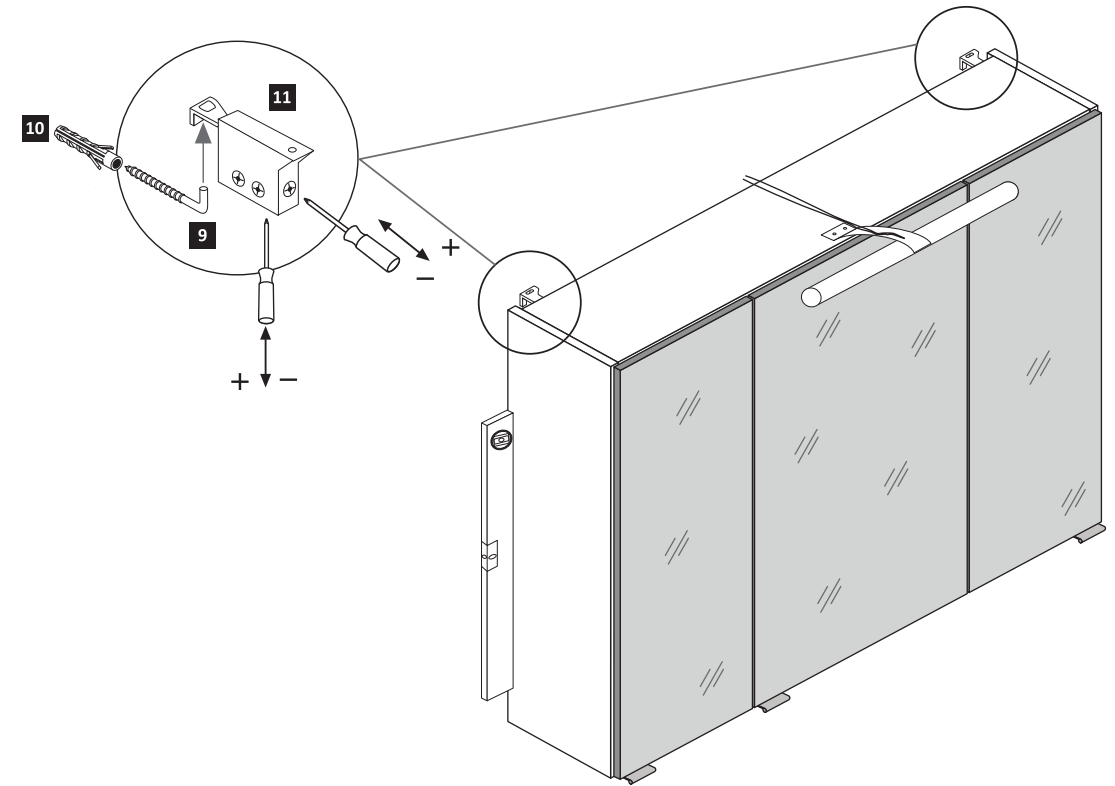
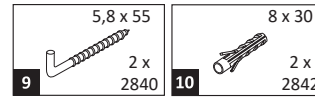

14

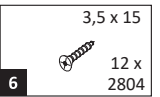

1. Türen einstellen.

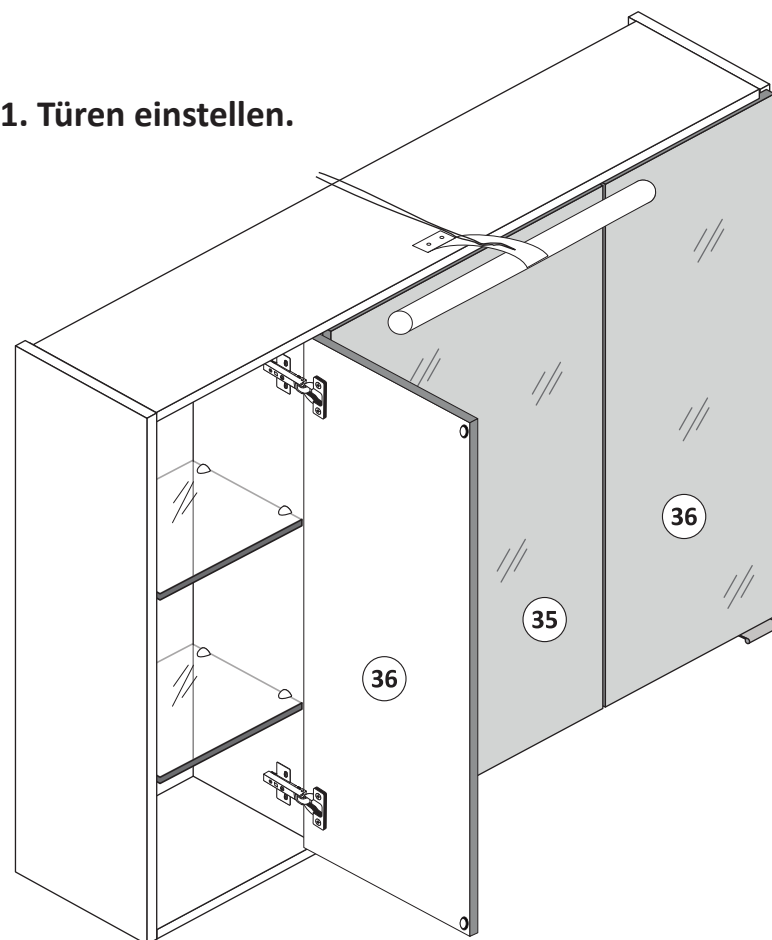
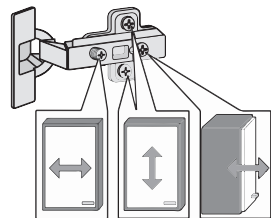

Achtung !!
Aus Sicherheitsgründen ist die Montage der Sicherungsschrauben zwingend notwendig. Nachdem montieren der Sicherungsschrauben ist die Höheneinstellung der Türen nicht mehr möglich!

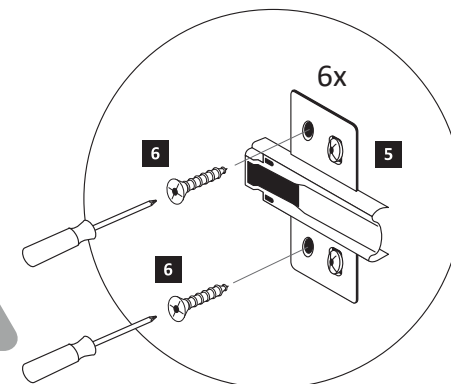

2. Sicherungsschrauben montieren.

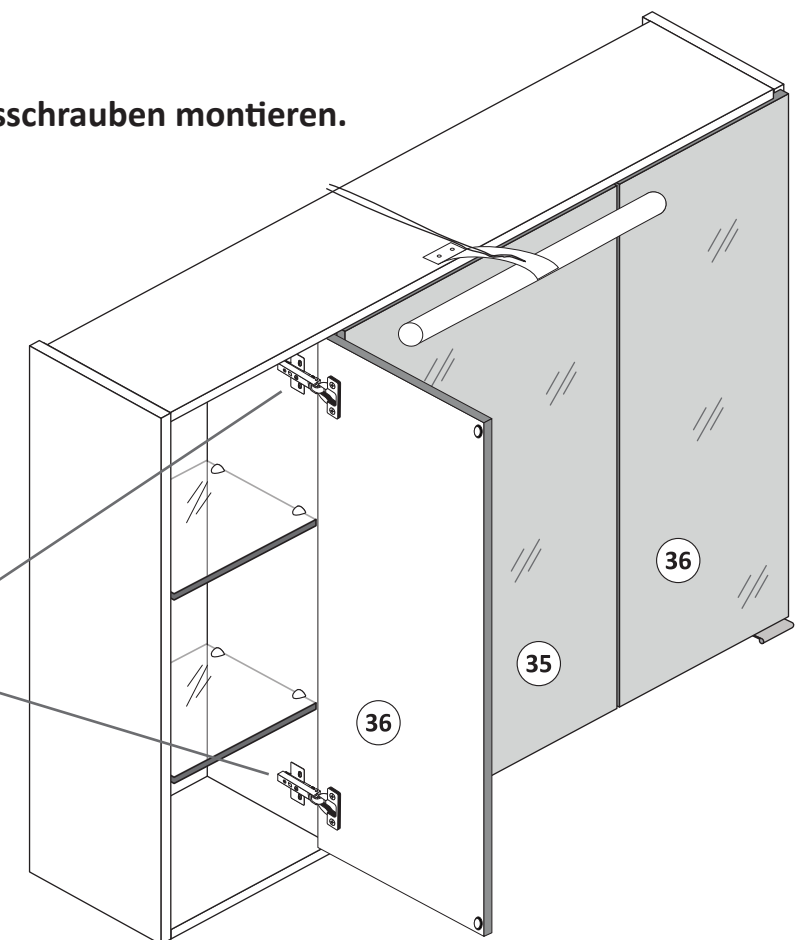



88084.531



3D-Effekt



1 4 x 2802	2 4 x 2801	gedämpft 3 x 1506	ungedämpft 3 x 1507	6 x 1614
3,5 x 15 26 x 2804	8 x 30 16 x 2861	4 x 30 4 x 2812	5,8 x 55 2 x 2840	8 x 30 2 x 2842
11 2 x 2843	12 6 x 2865	Leim 1 x 2863	14 24 x 2819	15 3 x 15 6 x 2803
3,5 x 17 20 x 2832	17 6 x 2552	18 1 x 2 x	20 1 x 4 x	3 x 15 6 x 2803
21 3 x 1098				

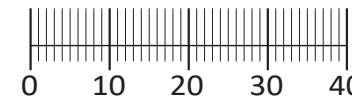

Das beigefügte Wandbefestigungsmaterial (Dübel und Schrauben) eignet sich nur für festes Mauerwerk (z.B.: Beton- oder Ziegelwände). Für andere Wandaufbauten sind eventuell Spezialdübel und andere Schrauben notwendig. Ziehen Sie gegebenenfalls eine Fachkraft zu Rate.

Приложенный материал для крепления к стене (дюбели и винты) пригоден только для жестких кладок (например, бетонные или кирпичные стены). Для других настенных конструкций необходимы смотря по обстоятельствам специальные дюбели и другие винты. При необходимости проконсультируйтесь у специалиста.

Załączony materiał do mocowania do ściany (kolki rozprężne i wkręty) nadaje się tylko do ścian murowanych (np. z betonu lub cegiel). Do ścian wykonanych w innych technologiach konieczne być mogą specjalne kolki rozprężne i inne wkręty. W razie potrzeby skorzystaj z fachowej pomocy

The accompanying wall mounting hardware (anchors and screws) is suitable only for solid masonry (eg concrete or brick walls). For other wall structures are possibly special anchor bolts and other necessary. Tighten if necessary, an expert.

De begeleidende wandmontage hardware (pluggen en schroeven) is alleen geschikt voor massief metselwerk (bijvoorbeeld beton of bakstenen muren). Voor andere muur structuren zijn eventueel bijzondere ankerbouten en andere noodzakelijke. Draai indien nodig, een deskundige.

Le mur d'accompagnement matériel de montage (chevilles et les vis) ne convient que pour la maçonnerie solide (par exemple en béton ou des murs de briques). Pour les structures de mur d'autres sont peut-être spéciale boulons d'ancrage et d'autres nécessaires. Serrer le cas échéant, un expert.

Il muro di accompagnamento hardware di montaggio (tasselli e viti) è'e adatto solo per muratura piena (ad esempio calcestruzzo o muratura). Per le altre strutture murarie sono forse speciali bulloni di ancoraggio e necessari di altri. Serrare se necessario, un esperto.

Ekteki duvara sabit montaj malzemeleri (dübel ve vidalar), sadece sağlam duvarlar için (örnek: beton veya tuğla) elverişlidir. Başka duvarlar için özel dübeller ve farklı vidalar gerekebilir. Gerekliğinde bir uzmana danışınız.

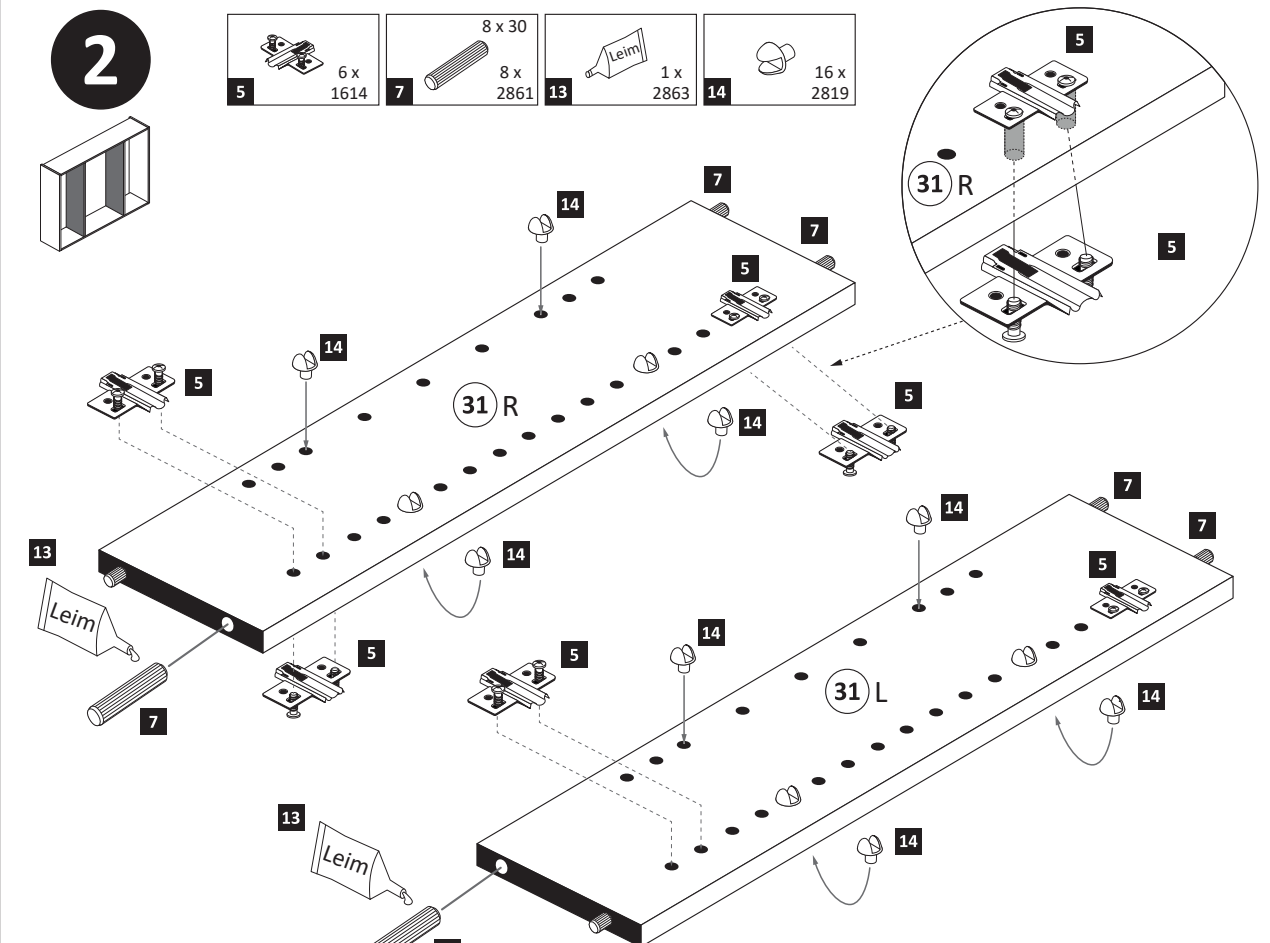
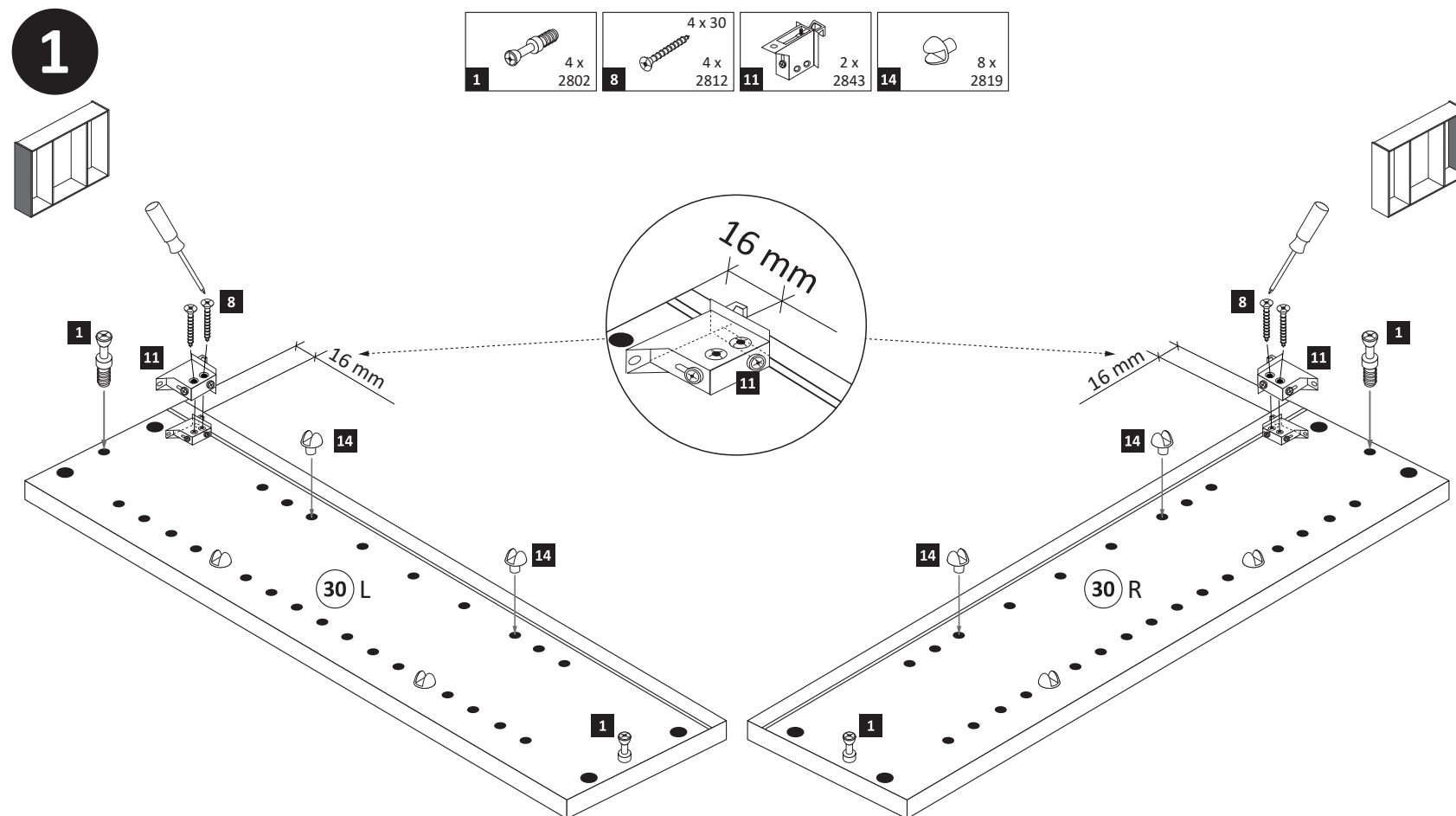
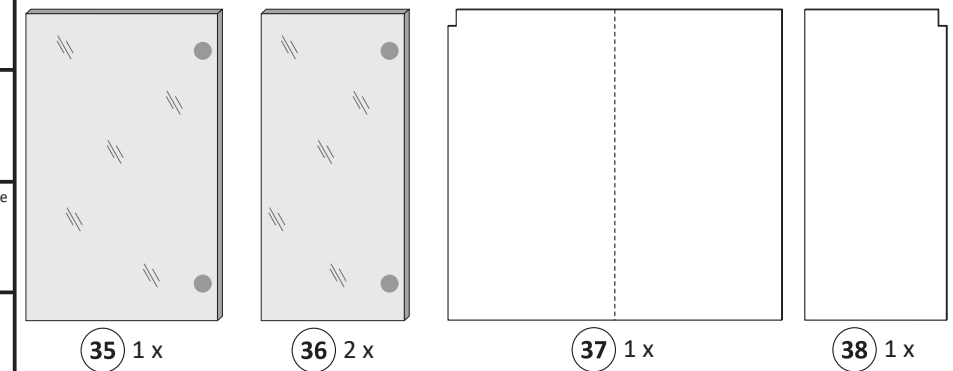
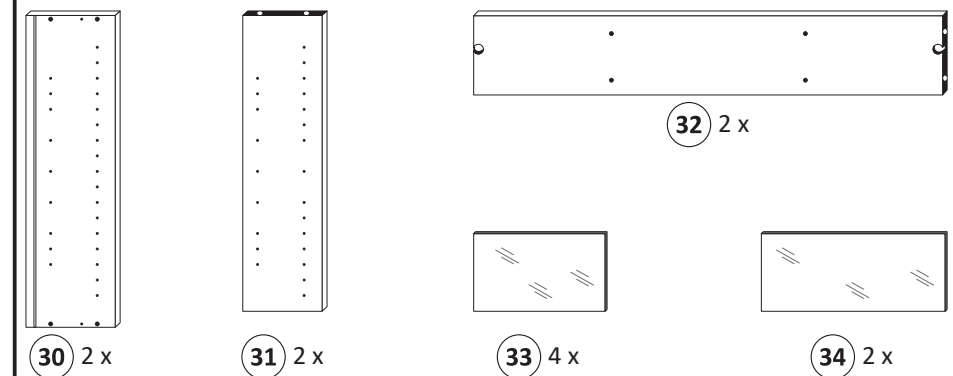

3

- 2 4 x 2801
- 7 8 x 30 2861
- 13 1 x 2863

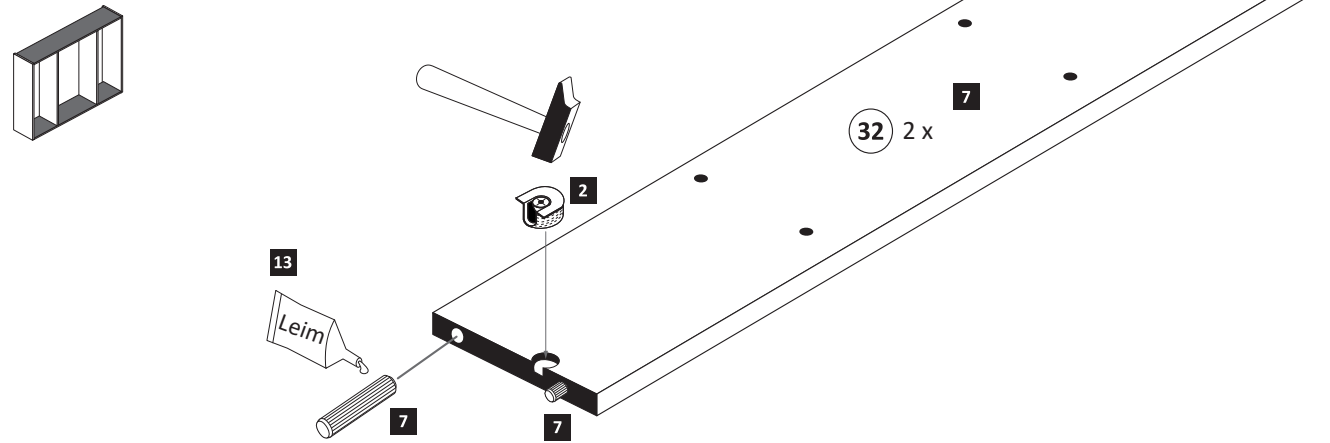

4

- 6 3,5 x 15 2804

- 13 1 x 2863
- 20 min.
- D Leim
- GB Glue
- NL Lijm
- PL Klej
- TR Tutkal
- F Colle
- I Colla

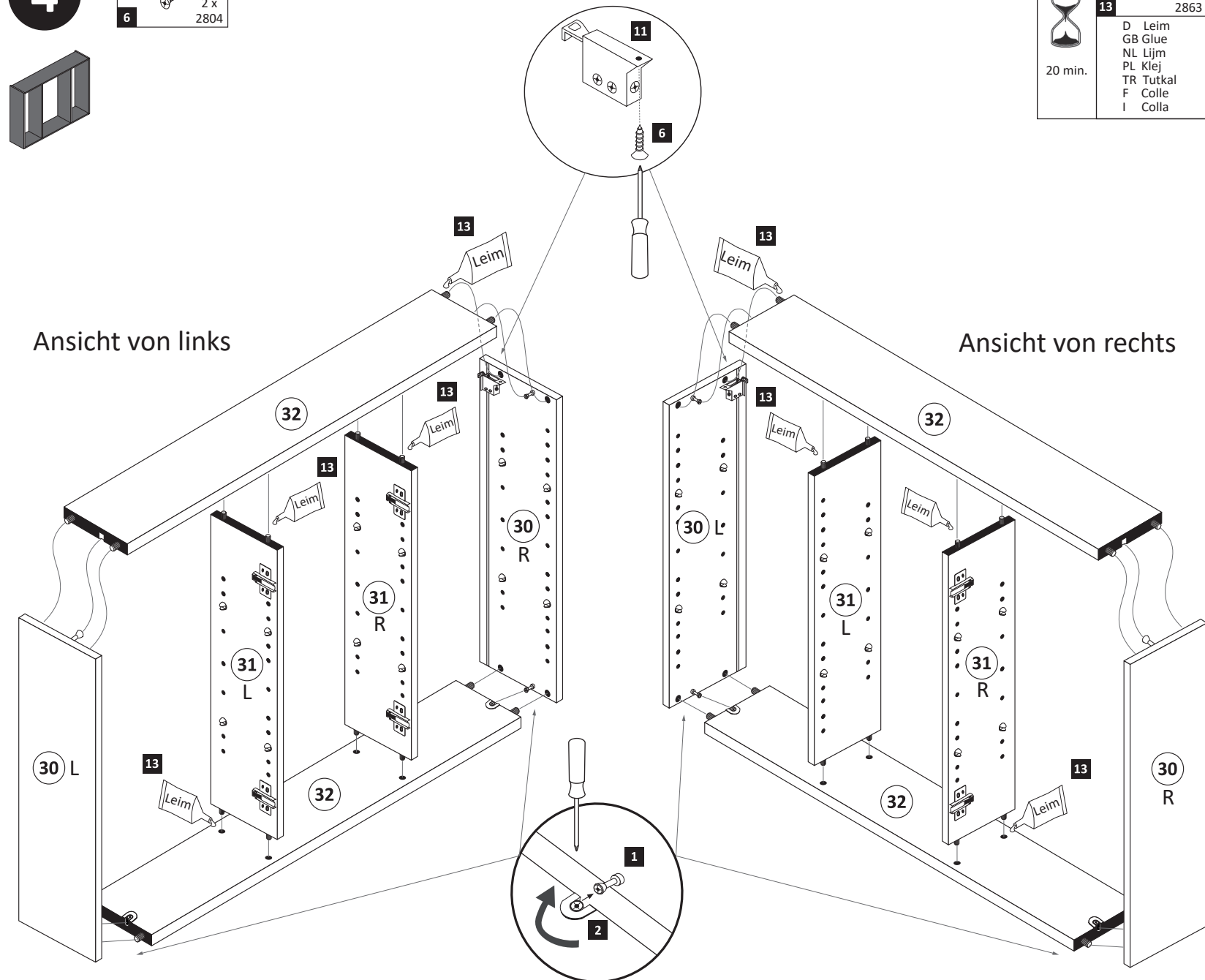

5

Bitte nur eine Variante auswählen und den entsprechenden Ausschnitt in einer Größe von maximal Trafobreite wie Trafohöhe - 10 mm aussägen. Trafomontage wird im Schritt 7 durchgeführt.

Variante 1: Trafomontage unten

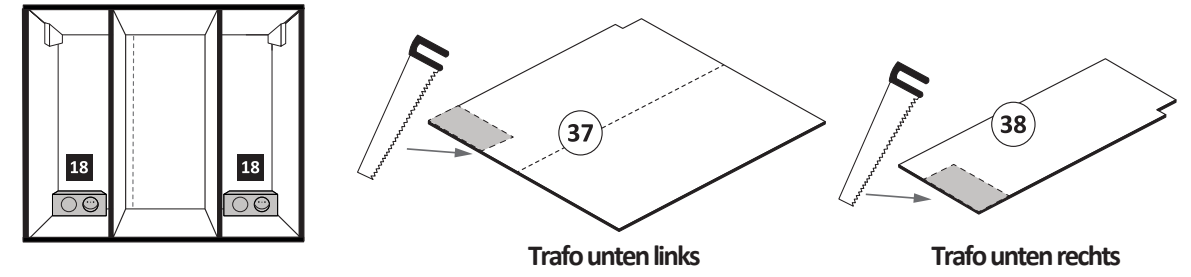

Variante 2: Trafomontage oben

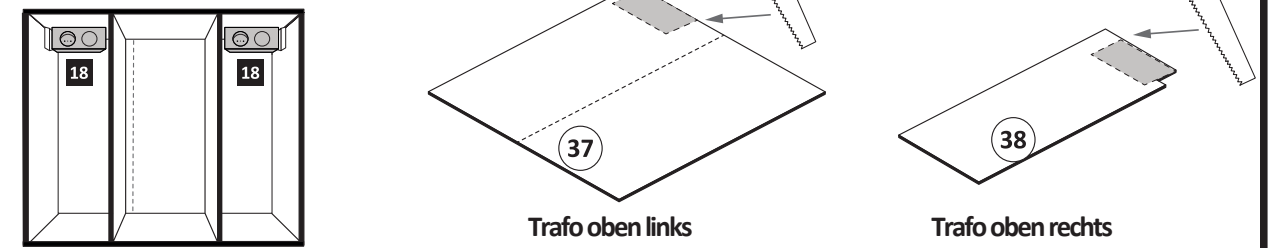

6

- 16 3,5 x 17 2832
- 17 6 x 2552

ACHTUNG !
Folgende Montageschritte mit dem Beispiel „Trafomontage Variante unten links“ !

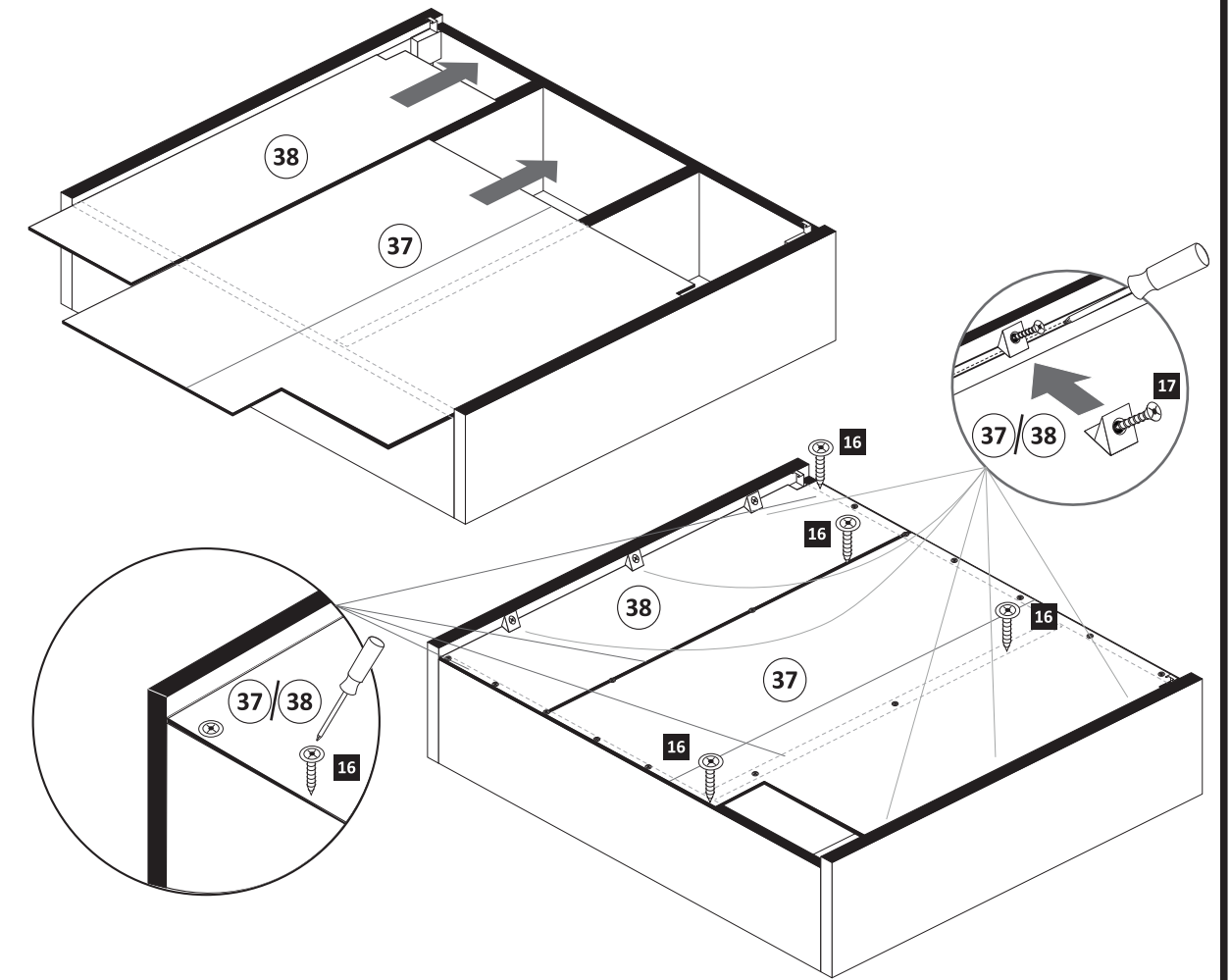

7

18 1x 2x

Achtung !!
Die Distanzhülsen
sind optional im
Lieferumfang.
Nur bei Bedarf nutzen.

8

33 34 33 34 33

10

35 36

Scharniermontage
1. 2.

Scharnier lösen 2.
1. (drücken)

9

gedämpft 3 x 1506 3
ungedämpft 3 x 1507 4
3,5 x 15 12 x 2804 6
6 x 2865 12

Scharnieransichten von unten

3 4 35 12 36 2 x 12

11

3 x 15 15 6 x 2803 21 3 x 1098

Unten

8 mm 21 15 5 mm

12

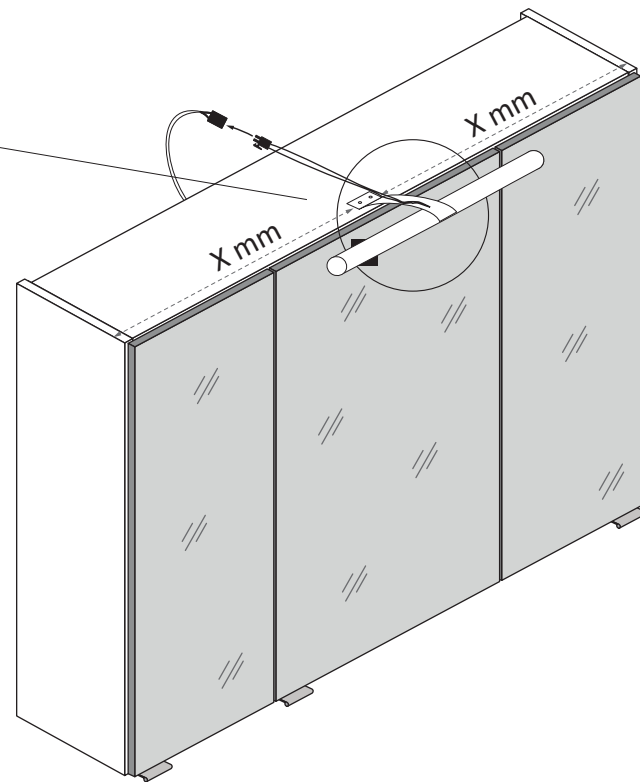
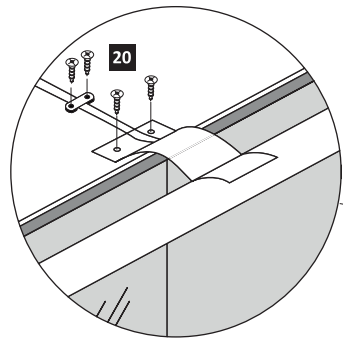
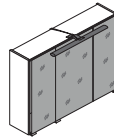
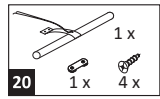

13

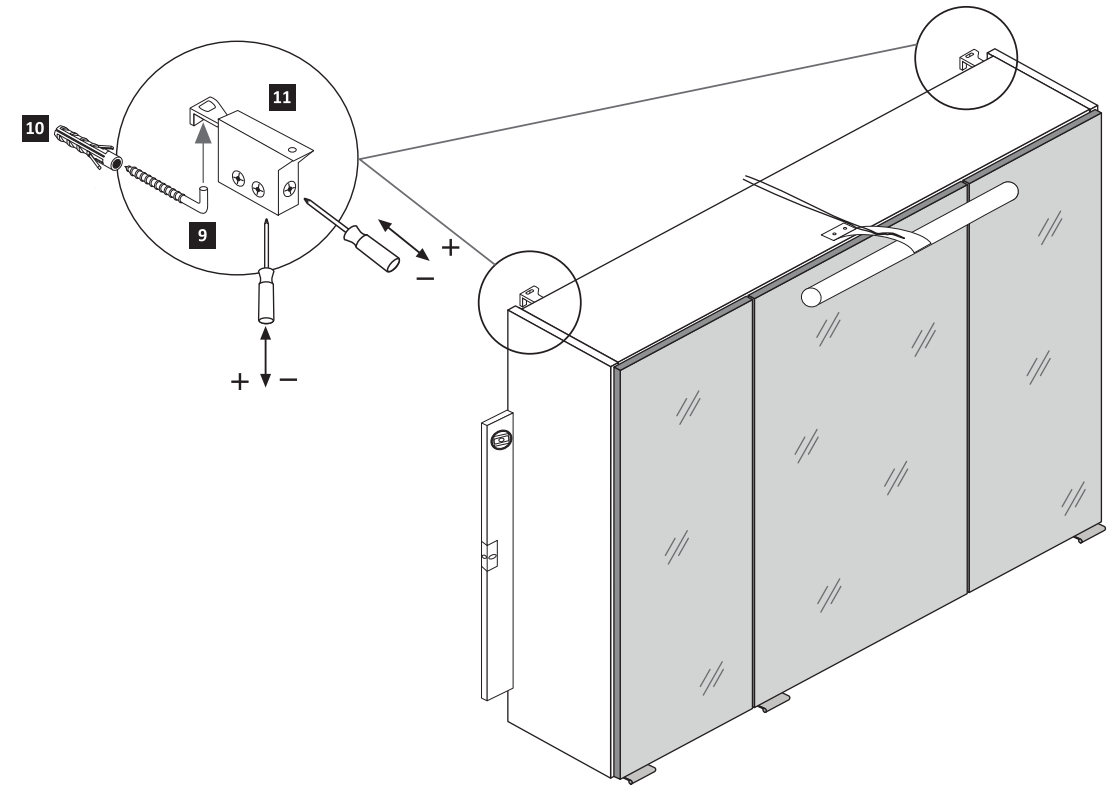
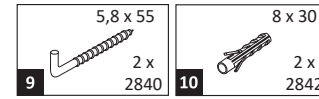

14

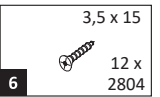

1. Türen einstellen.

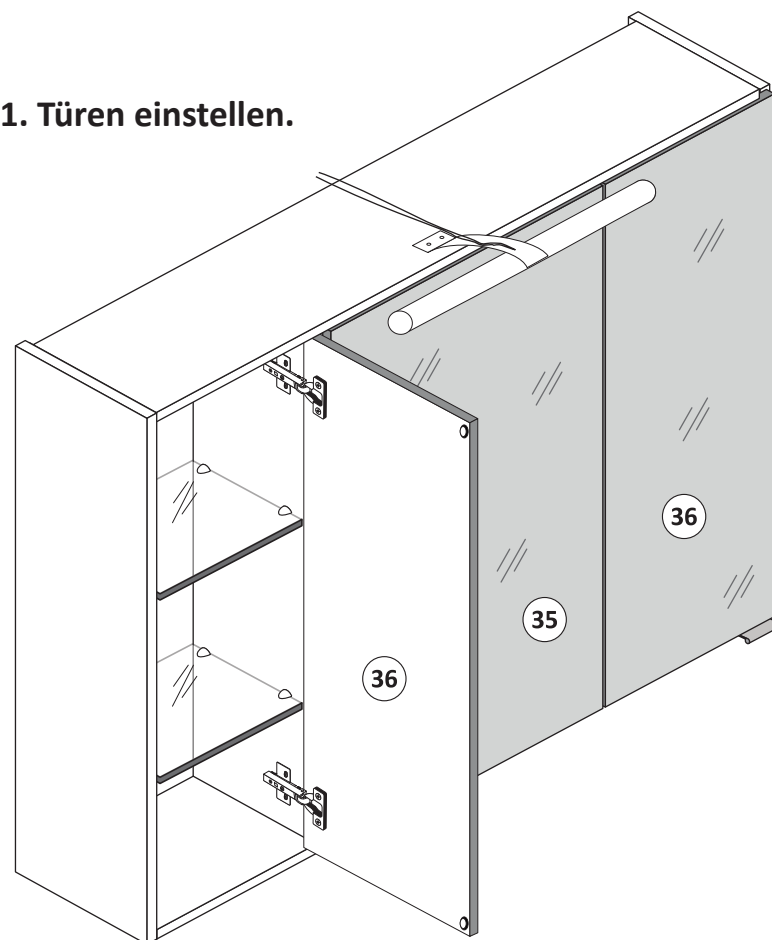
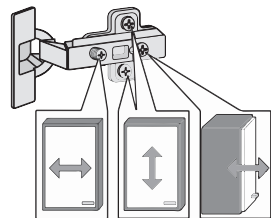

Achtung !!
Aus Sicherheitsgründen ist die Montage der Sicherungsschrauben zwingend notwendig. Nachdem montieren der Sicherungsschrauben ist die Höheneinstellung der Türen nicht mehr möglich!

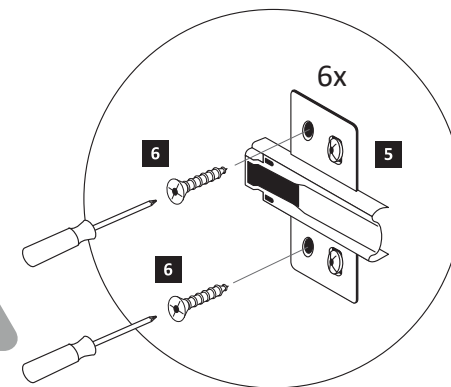

2. Sicherungsschrauben montieren.

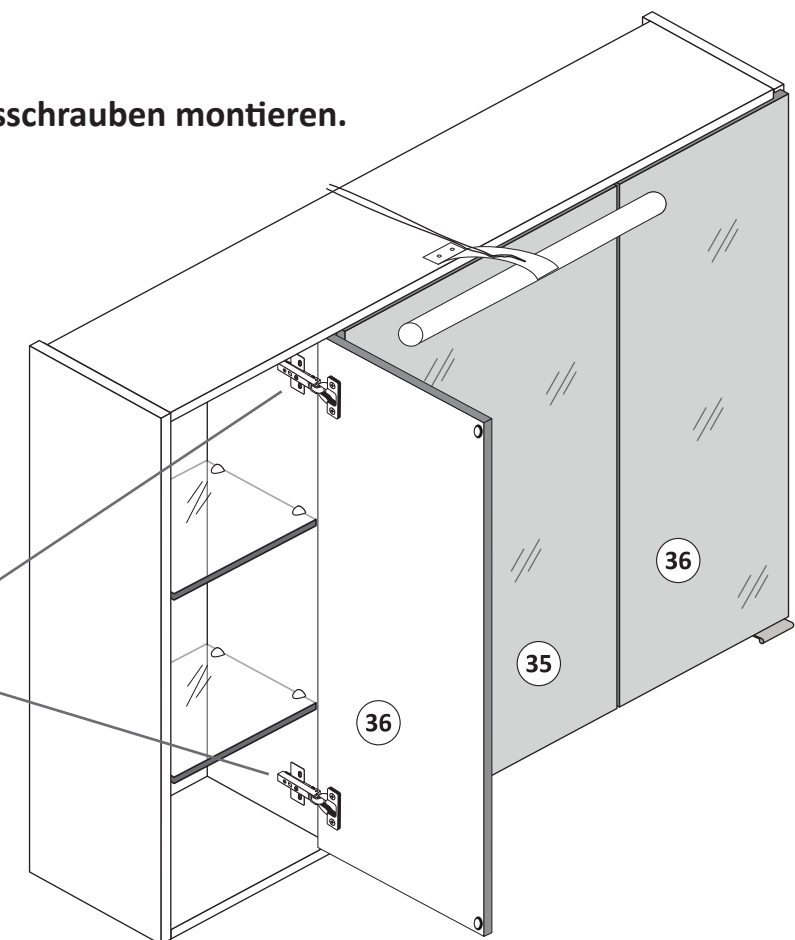



88084.531

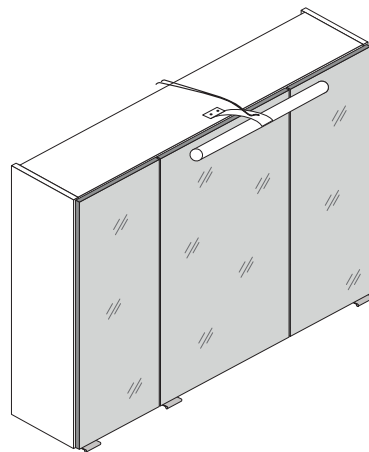

3D-Effekt

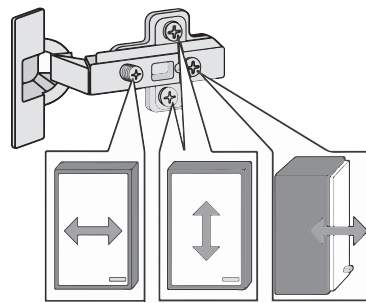
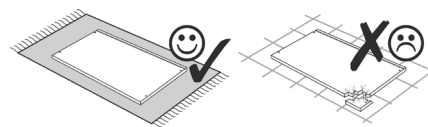
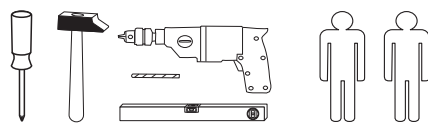
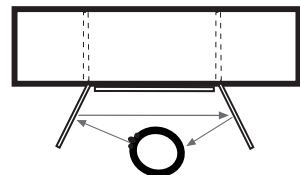

1 4 x 2802	2 4 x 2801	gedämpft 3 x 1506	ungedämpft 3 x 1507	6 x 1614
3,5 x 15 26 x 2804	8 x 30 16 x 2861	4 x 30 4 x 2812	5,8 x 55 2 x 2840	8 x 30 2 x 2842
11 2 x 2843	12 6 x 2865	Leim 1 x 2863	14 24 x 2819	15 3 x 15 6 x 2803
3,5 x 17 20 x 2832	17 6 x 2552	18 1 x 2 x	20 1 x 4 x	21 3 x 1098

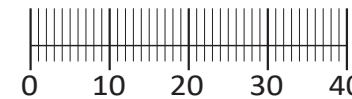

Das beigefügte Wandbefestigungsmaterial (Dübel und Schrauben) eignet sich nur für festes Mauerwerk (z.B.: Beton- oder Ziegelwände). Für andere Wandaufbauten sind eventuell Spezialdübel und andere Schrauben notwendig. Ziehen Sie gegebenenfalls eine Fachkraft zu Rate.

De begeleidende wandmontage hardware (pluggen en schroeven) is alleen geschikt voor massief metselwerk (bijvoorbeeld beton of bakstenen muren). Voor andere muur structuren zijn eventueel bijzondere ankerbouten en andere noodzakelijke. Draai indien nodig, een deskundige.

Приложенный материал для крепления к стене (дюбели и винты) пригоден только для жестких кладок (например, бетонные или кирпичные стены). Для других настенных конструкций необходимы смотря по обстоятельствам специальные дюбели и другие винты. При необходимости проконсультируйтесь у специалиста.

Le mur d'accompagnement matériel de montage (chevilles et les vis) ne convient que pour la maçonnerie solide (par exemple en béton ou des murs de briques). Pour les structures de mur d'autres sont peut-être spéciale boulons d'ancrage et d'autres nécessaires. Serrer le cas échéant, un expert.

Załączony materiał do mocowania do ściany (kolki rozprężne i wkręty) nadaje się tylko do ścian murowanych (np. z betonu lub cegieł). Do ścian wykonanych w innych technologiach konieczne być mogą specjalne kolki rozprężne i inne wkręty. W razie potrzeby skorzystaj z fachowej pomocy

Il muro di accompagnamento hardware di montaggio (tasselli e viti) è'e adatto solo per muratura piena (ad esempio calcestruzzo o muratura). Per le altre strutture murarie sono forse speciali bulloni di ancoraggio e necessari di altri. Serrare se necessario, un esperto.

The accompanying wall mounting hardware (anchors and screws) is suitable only for solid masonry (eg concrete or brick walls). For other wall structures are possibly special anchor bolts and other necessary. Tighten if necessary, an expert.

Ekteki duvara sabit montaj malzemeleri (dübel ve vidalar), sadece sağlam duvarlar için (örnek: beton veya tuğla) elverişlidir. Başka duvarlar için özel dübeller ve farklı vidalar gerekebilir. Gerektiğinde bir uzmana danışınız.

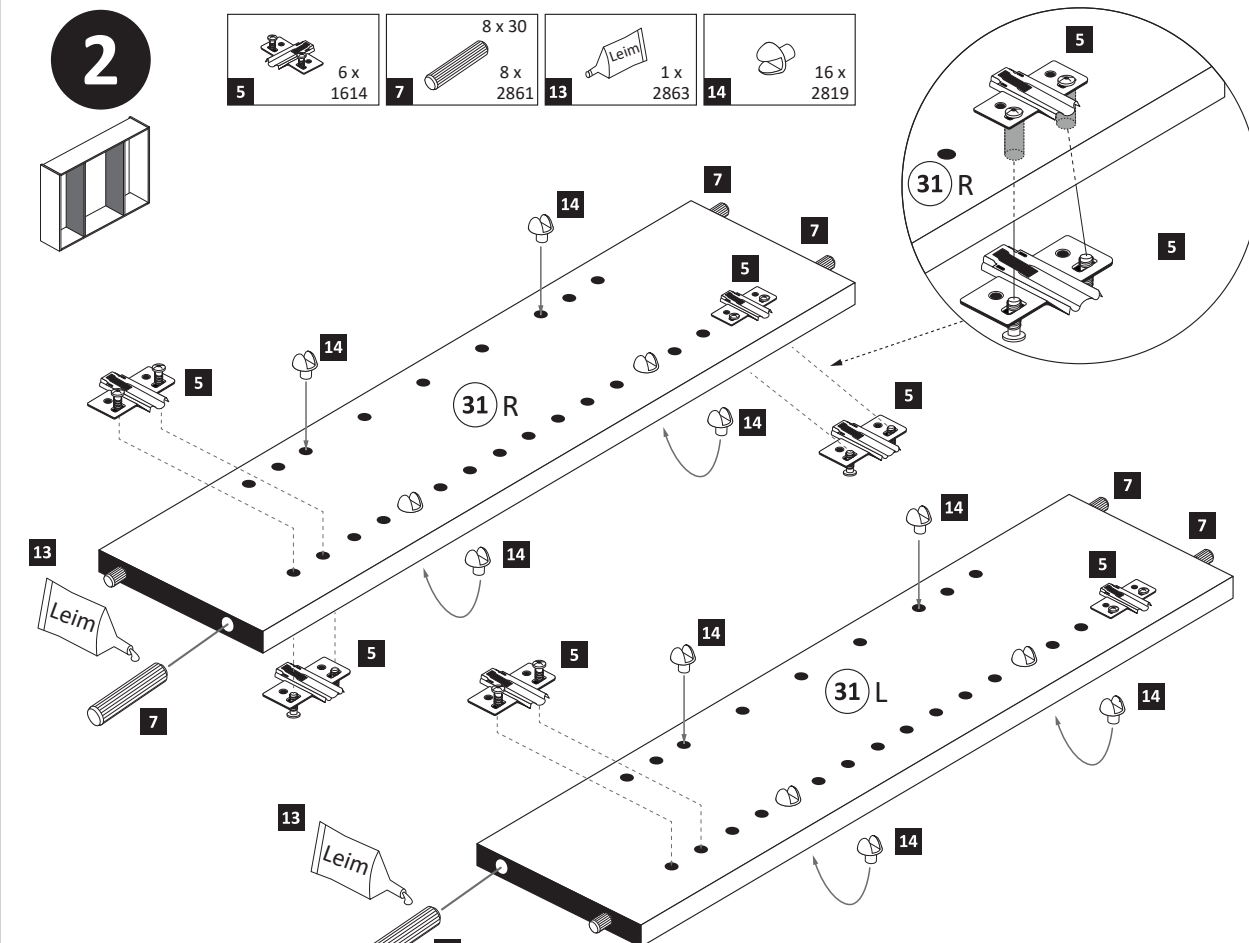
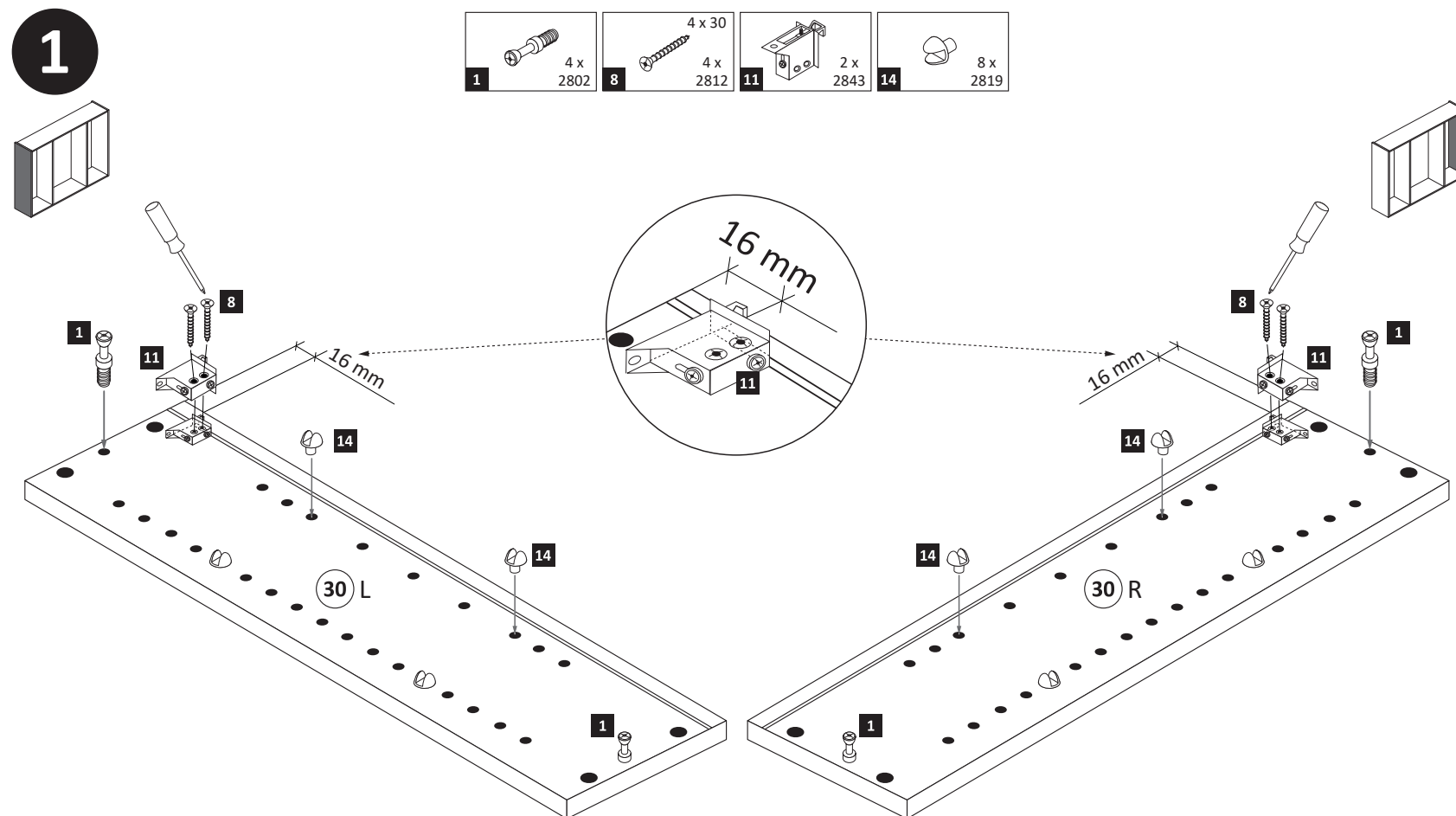
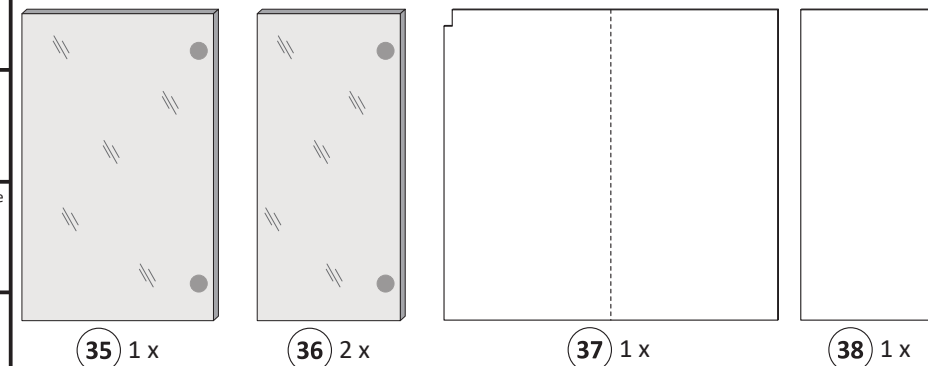
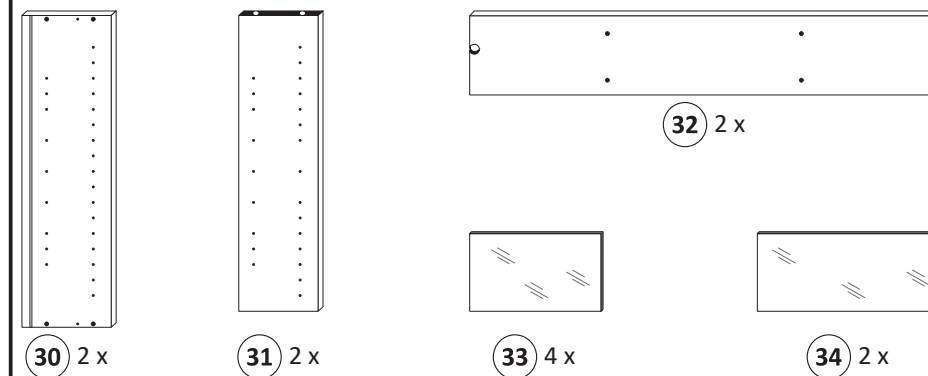

3

- 2 4 x 2801
- 7 8 x 30 2861
- 13 1 x 2863

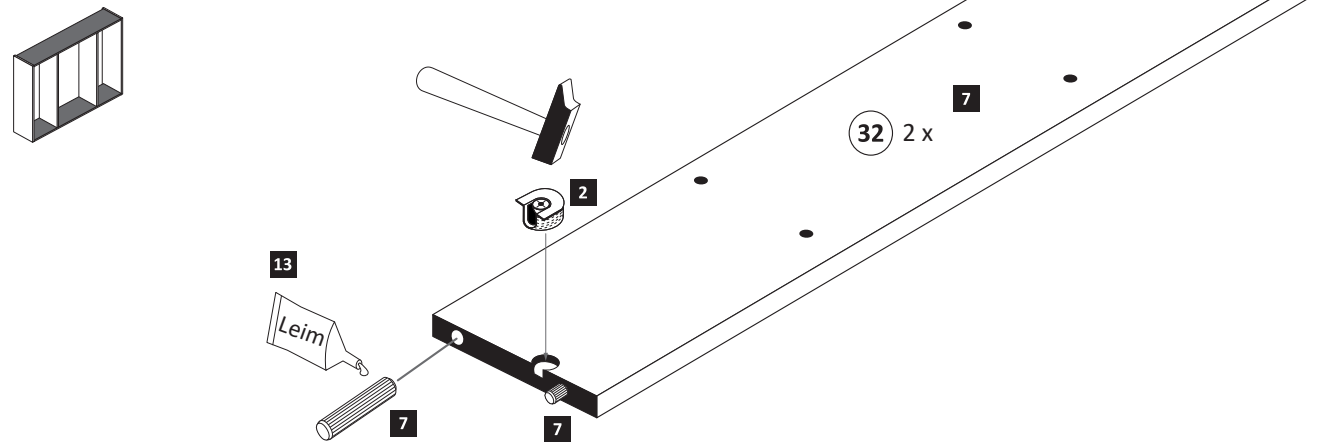

4

- 6 3,5 x 15 2804

- 13 1 x 2863
- 20 min.
- D Leim
 - GB Glue
 - NL Lijm
 - PL Klej
 - TR Tutkal
 - F Colle
 - I Colla

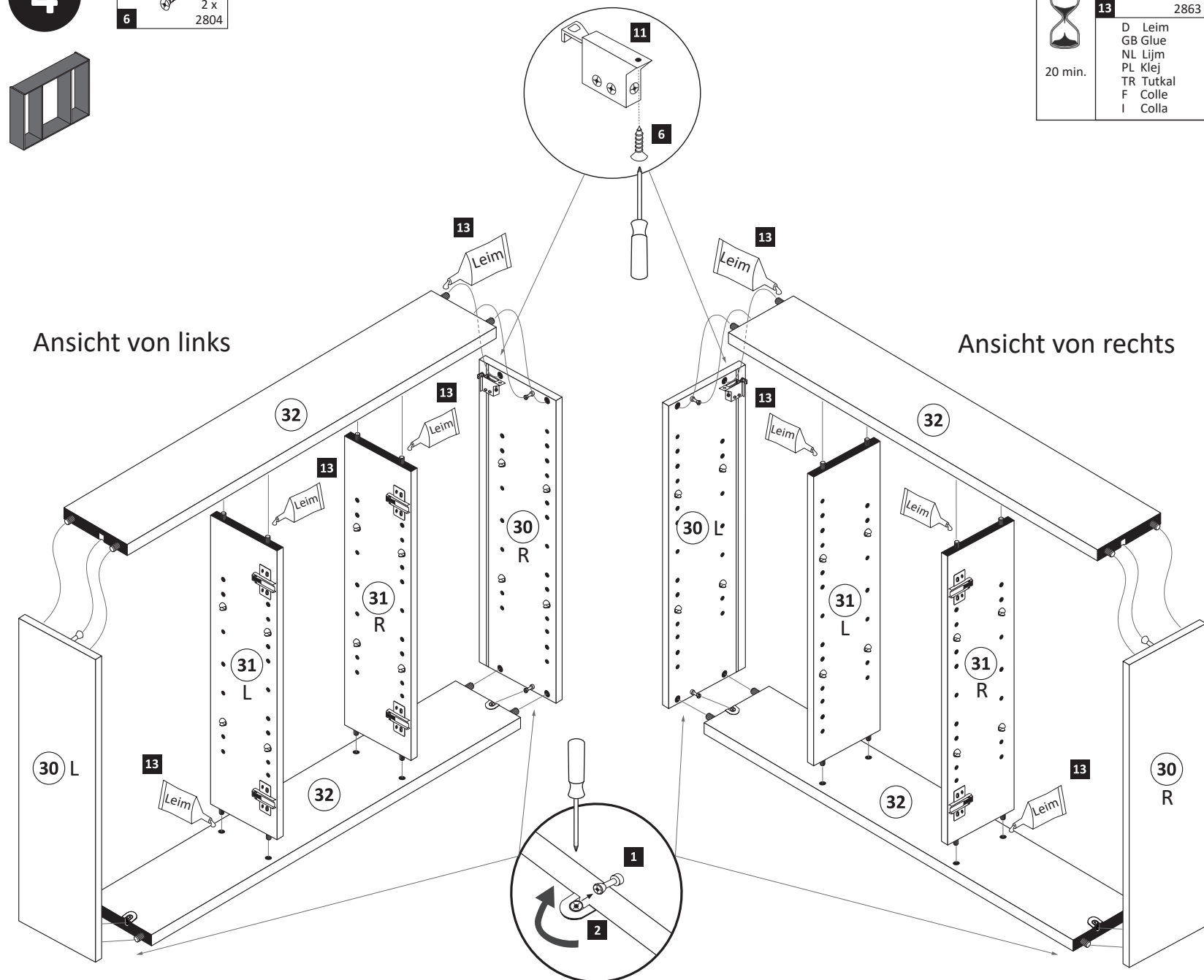

5

Bitte nur eine Variante auswählen und den entsprechenden Ausschnitt in einer Größe von maximal Trafobreite wie Trafohöhe - 10 mm aussägen. Trafomontage wird im Schritt 7 durchgeführt.

Variante 1: Trafomontage unten

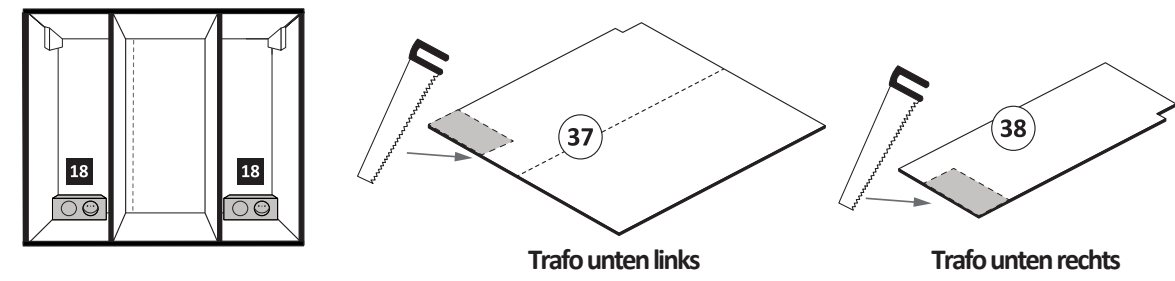

Variante 2: Trafomontage oben

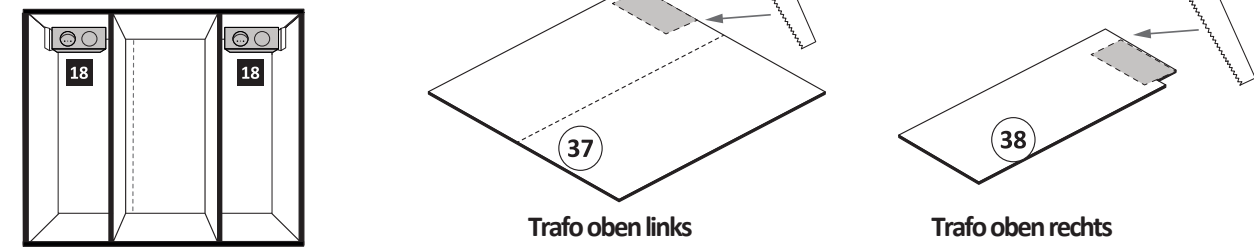

6

- 16 3,5 x 17 2832
- 17 6 x 2552

ACHTUNG !
Folgende Montageschritte mit dem Beispiel „Trafomontage Variante unten links“ !

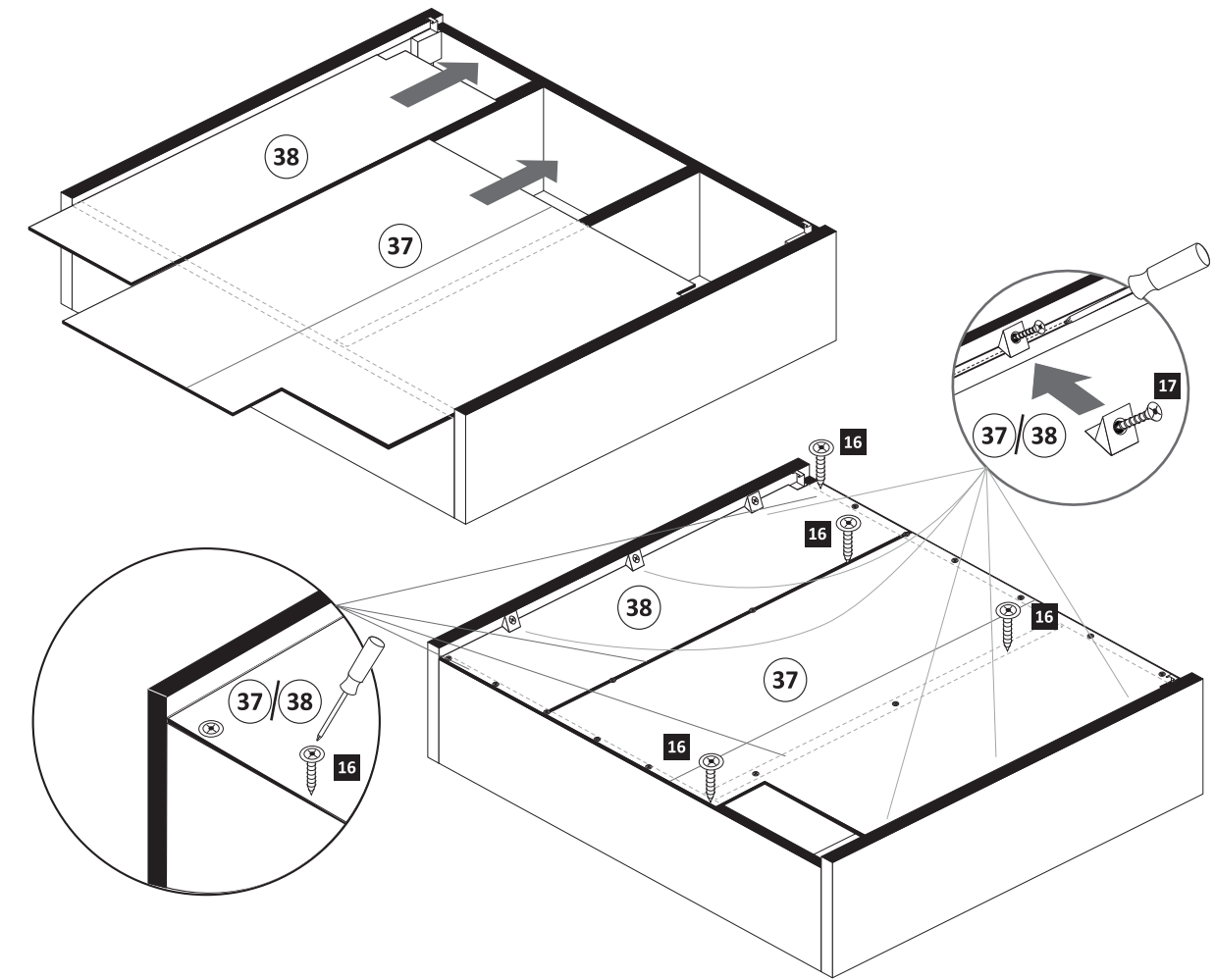

7

18 1x 2x

Achtung !!
Die Distanzhülsen sind optional im Lieferumfang.
Nur bei Bedarf nutzen.

8

33 34 33 34 33

10

35 36 36

Scharniermontage

1. 2.

Scharnier lösen 2. 1. (drücken)

9

gedämpft 3 x 1506 3
ungedämpft 3 x 1507 4
3,5 x 15 12 x 2804 6
6 x 2865 12

3 4 6 12 35 36 2 x 12

Scharnieransichten von unten

11

3 x 15 15 6 x 2803 21 3 x 1098

15 21 3 x 1098

8 mm 5 mm

Unten

12

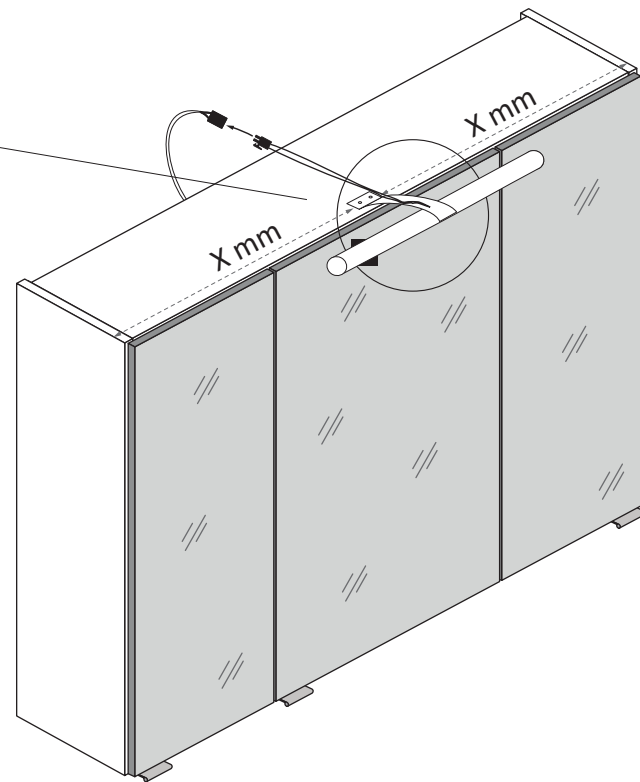
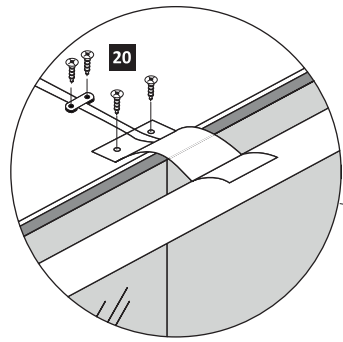
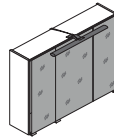
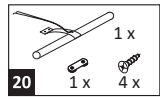

13

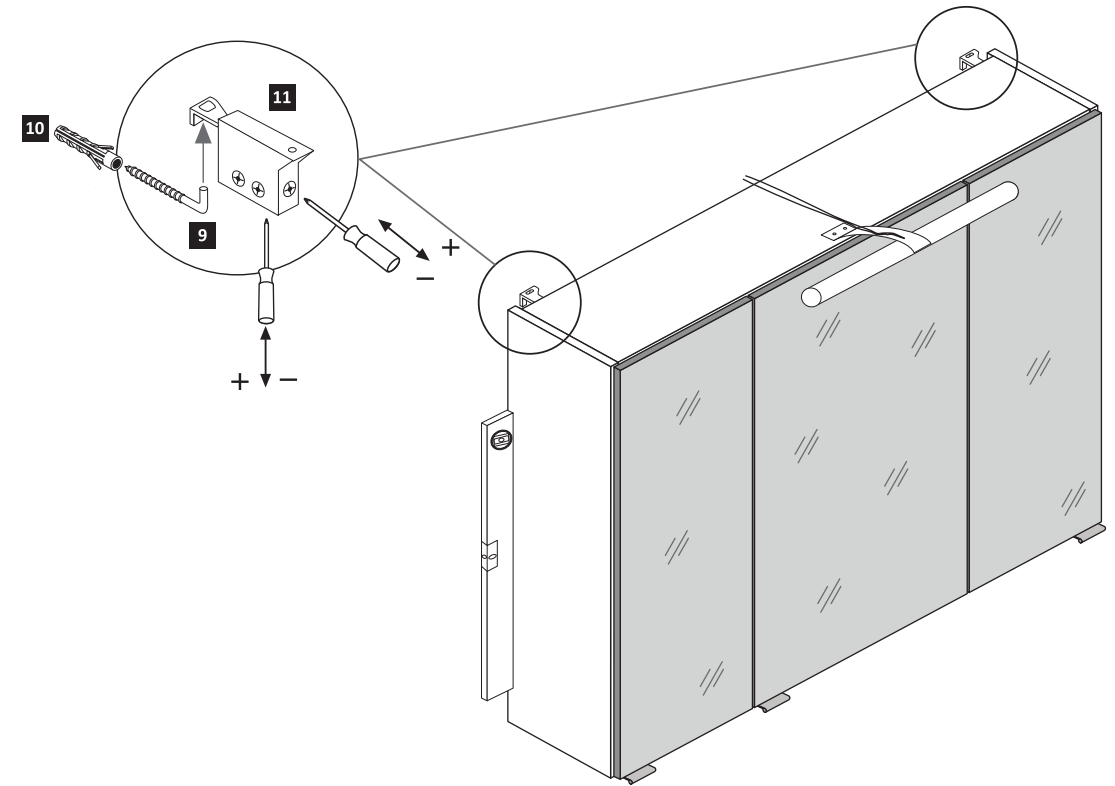
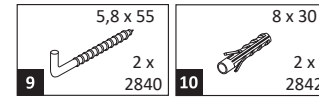

14

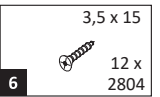

1. Türen einstellen.

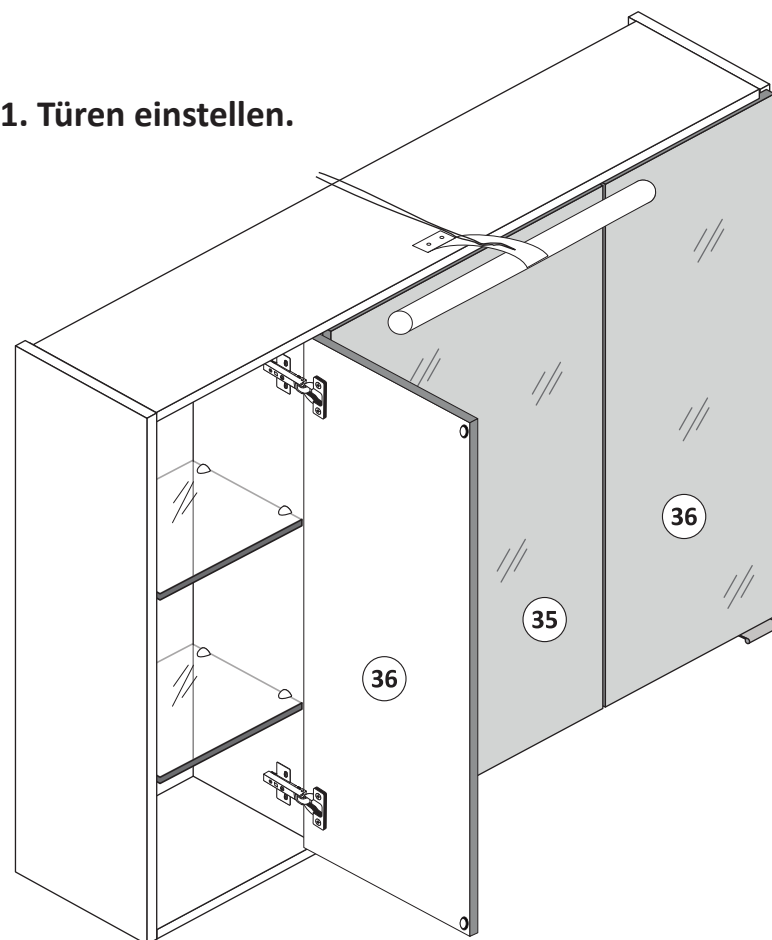
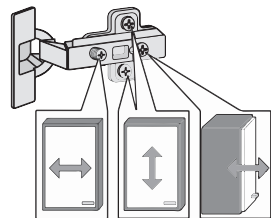

Achtung !!
Aus Sicherheitsgründen ist die Montage der Sicherungsschrauben zwingend notwendig. Nachdem montieren der Sicherungsschrauben ist die Höheneinstellung der Türen nicht mehr möglich!

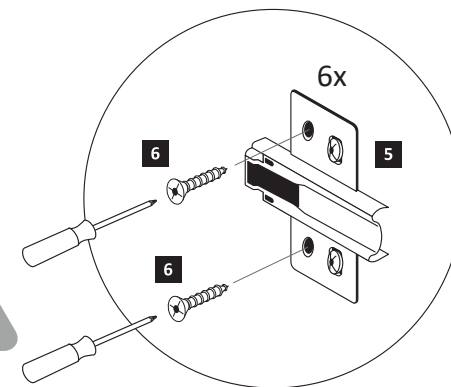

2. Sicherungsschrauben montieren.

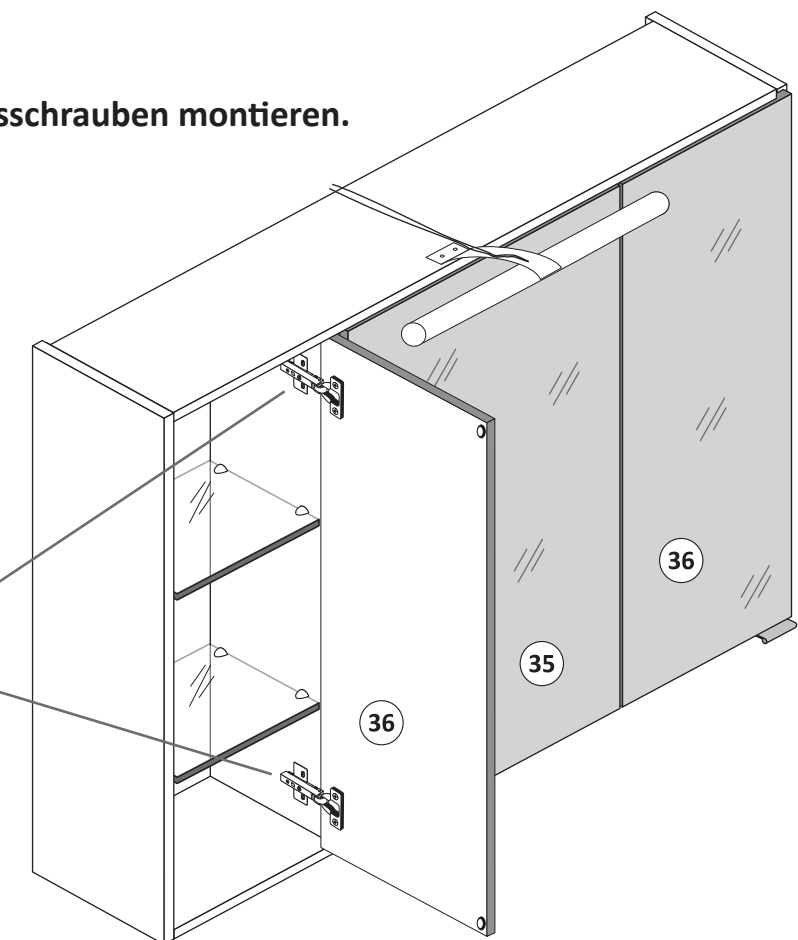



88084.531



3D-Effekt



1 4 x 2802	2 4 x 2801	gedämpft 3 x 1506	ungedämpft 3 x 1507	6 x 1614
3,5 x 15 26 x 2804	8 x 30 16 x 2861	4 x 30 4 x 2812	5,8 x 55 2 x 2840	8 x 30 2 x 2842
2 x 2843	6 x 2865	Leim 1 x 2863	24 x 2819	3 x 15 6 x 2803
3,5 x 17 20 x 2832	6 x 2552	1 x 2	1 x 4 x	1 x
3 x 1098				

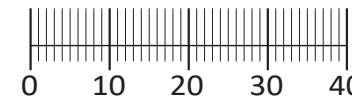

Das beigefügte Wandbefestigungsmaterial (Dübel und Schrauben) eignet sich nur für festes Mauerwerk (z.B.: Beton- oder Ziegelwände). Für andere Wandaufbauten sind eventuell Spezialdübel und andere Schrauben notwendig. Ziehen Sie gegebenenfalls eine Fachkraft zu Rate.

Приложенный материал для крепления к стене (дюбели и винты) пригоден только для жестких кладок (например, бетонные или кирпичные стены). Для других настенных конструкций необходимы смотря по обстоятельствам специальные дюбели и другие винты. При необходимости проконсультируйтесь у специалиста.

Załączony materiał do mocowania do ściany (kolki rozprężne i wkręty) nadaje się tylko do ścian murowanych (np. z betonu lub cegieł). Do ścian wykonanych w innych technologiach konieczne być mogą specjalne kolki rozprężne i inne wkręty. W razie potrzeby skorzystaj z fachowej pomocy.

The accompanying wall mounting hardware (anchors and screws) is suitable only for solid masonry (eg concrete or brick walls). For other wall structures are possibly special anchor bolts and other necessary. Tighten if necessary, an expert.

De begeleidende wandmontage hardware (pluggen en schroeven) is alleen geschikt voor massief metselwerk (bijvoorbeeld beton of bakstenen muren). Voor andere muur structuren zijn eventueel bijzondere ankerbouten en andere noodzakelijke. Draai indien nodig, een deskundige.

Le mur d'accompagnement matériel de montage (chevilles et les vis) ne convient que pour la maçonnerie solide (par exemple en béton ou des murs de briques). Pour les structures de mur d'autres sont peut-être spéciale boulons d'ancrage et d'autres nécessaires. Serrer le cas échéant, un expert.

Il muro di accompagnamento hardware di montaggio (tasselli e viti) è adatto solo per muratura piena (ad esempio calcestruzzo o muratura). Per le altre strutture murarie sono forse speciali bulloni di ancoraggio e necessari di altri. Serrare se necessario, un esperto.

Ekteki duvara sabit montaj malzemeleri (dübel ve vidalar), sadece sağlam duvarlar için (örnek: beton veya tuğla) elverişlidir. Başka duvarlar için özel dübeller ve farklı vidalar gerekebilir. Gerekliğinde bir uzmana danışınız.

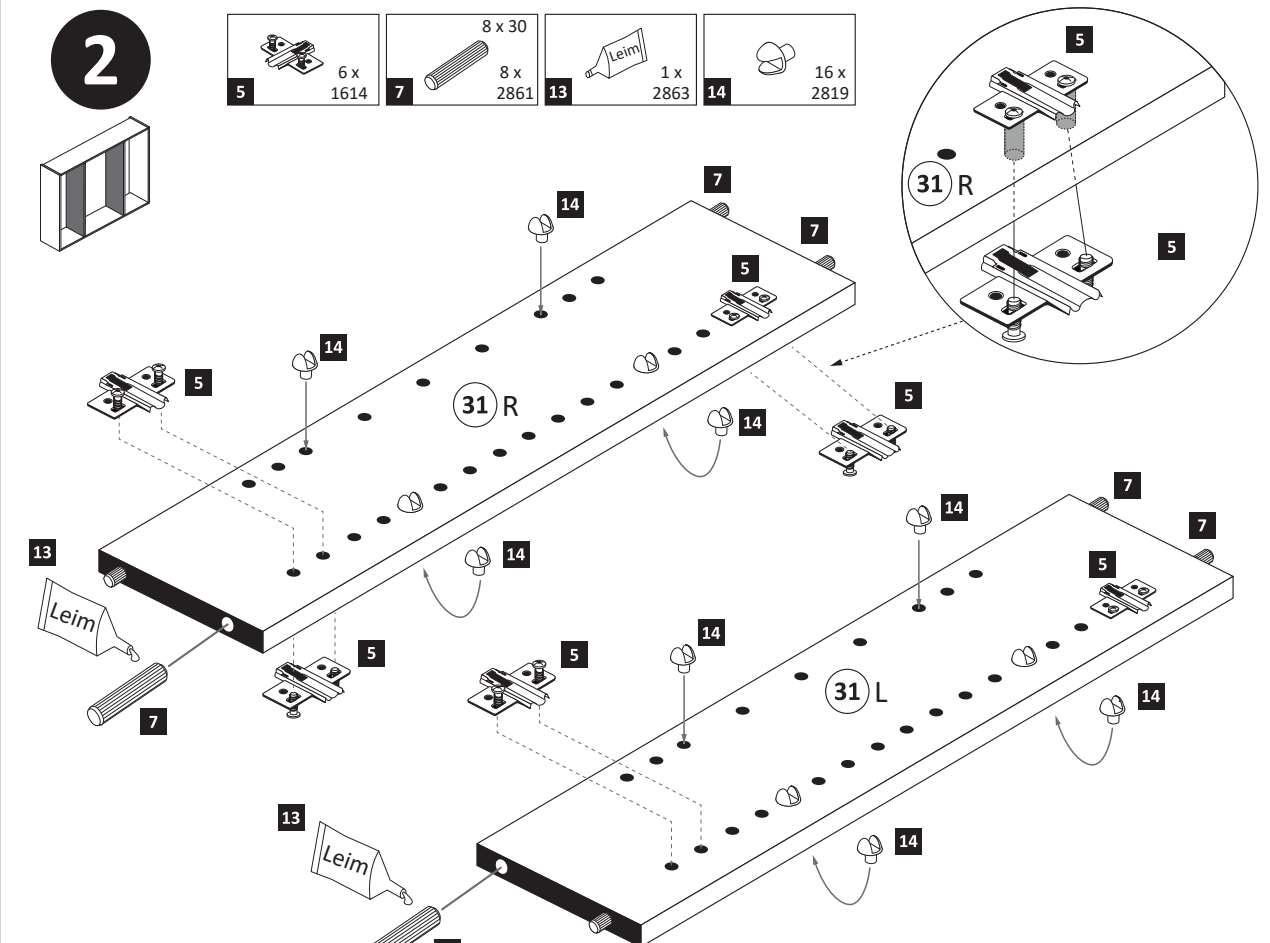
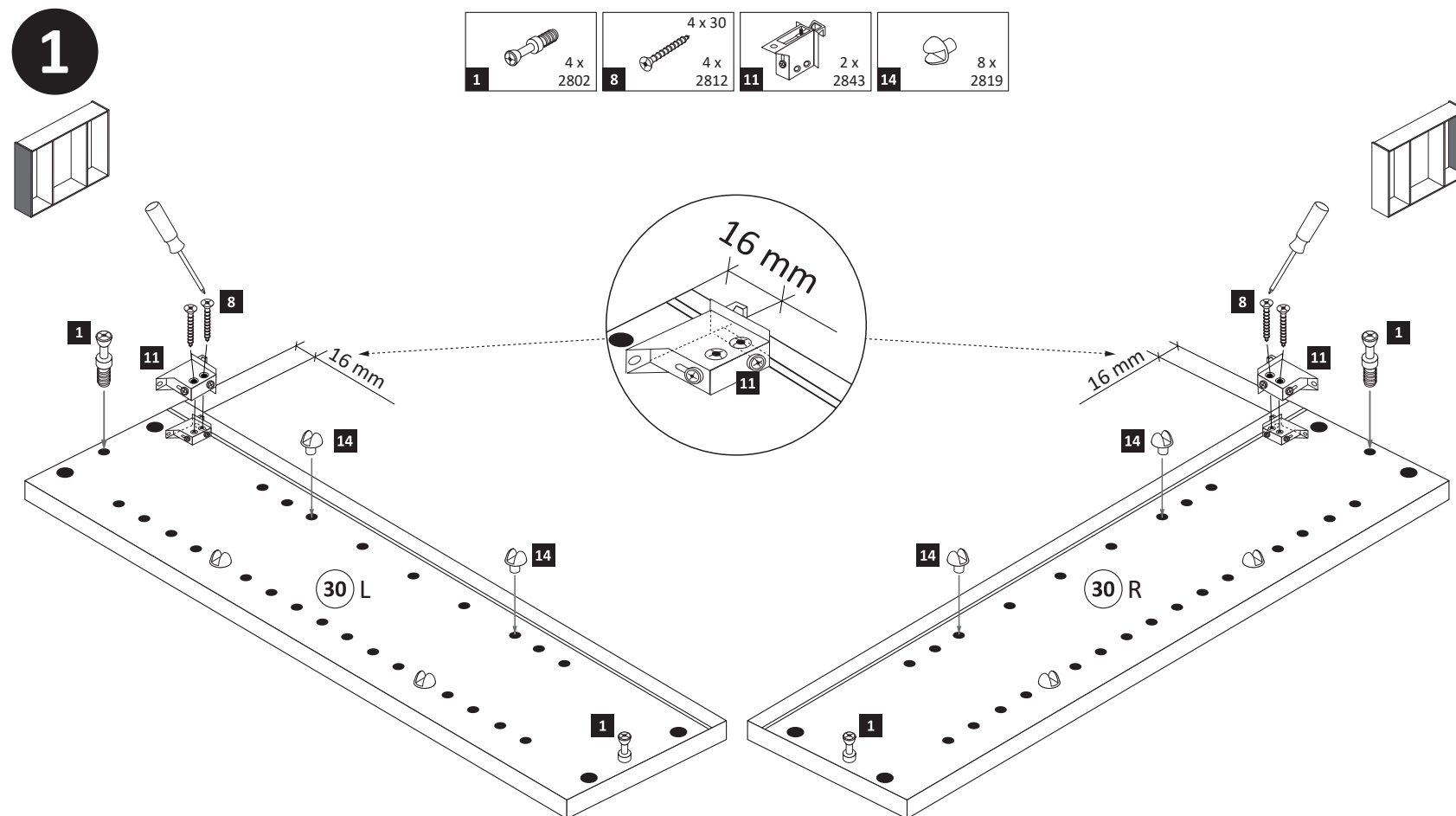
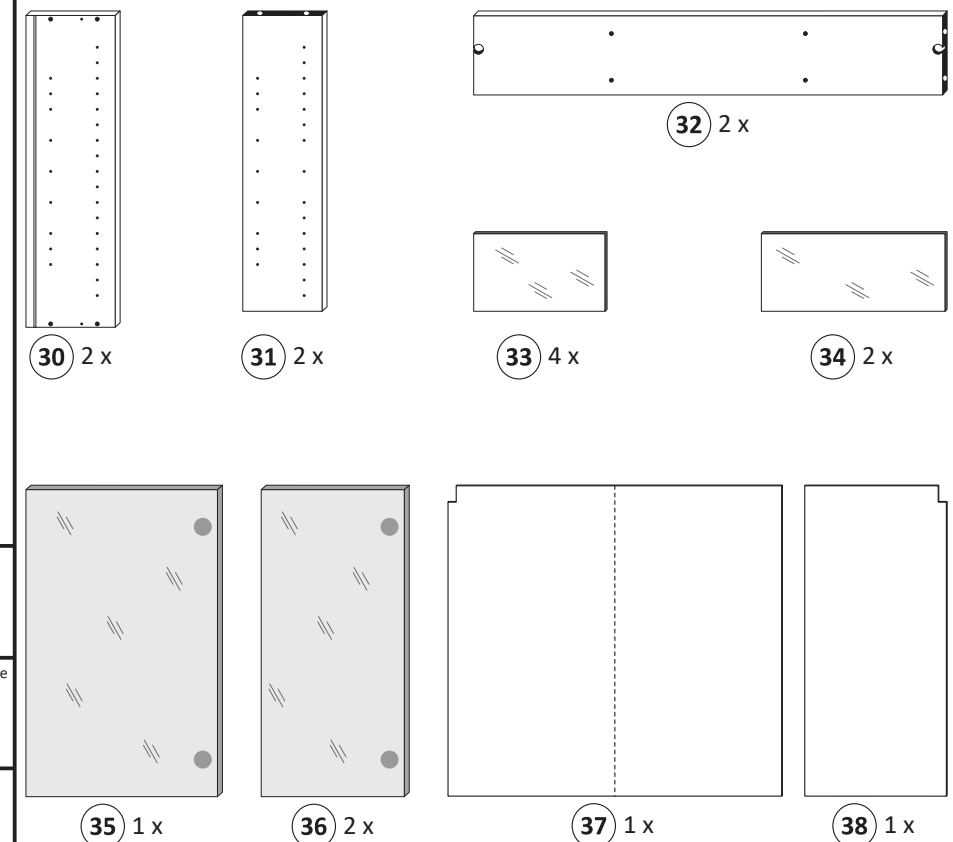

3

- 2 4 x 2801
- 7 8 x 30 2861
- 13 1 x 2863

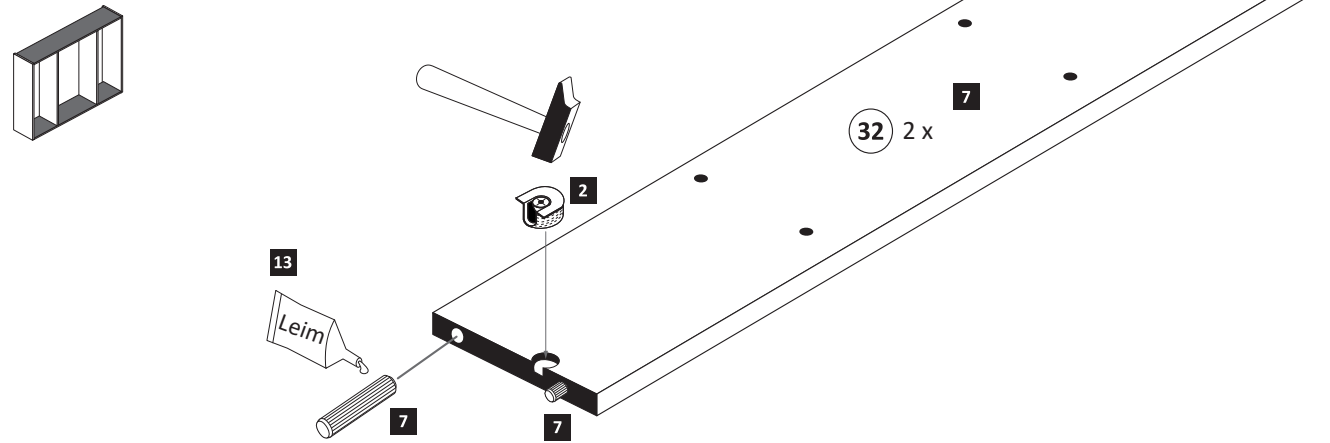

4

- 6 3,5 x 15 2804

- 13 1 x 2863
- 20 min.
- D Leim
 - GB Glue
 - NL Lijm
 - PL Klej
 - TR Tutkal
 - F Colle
 - I Colla

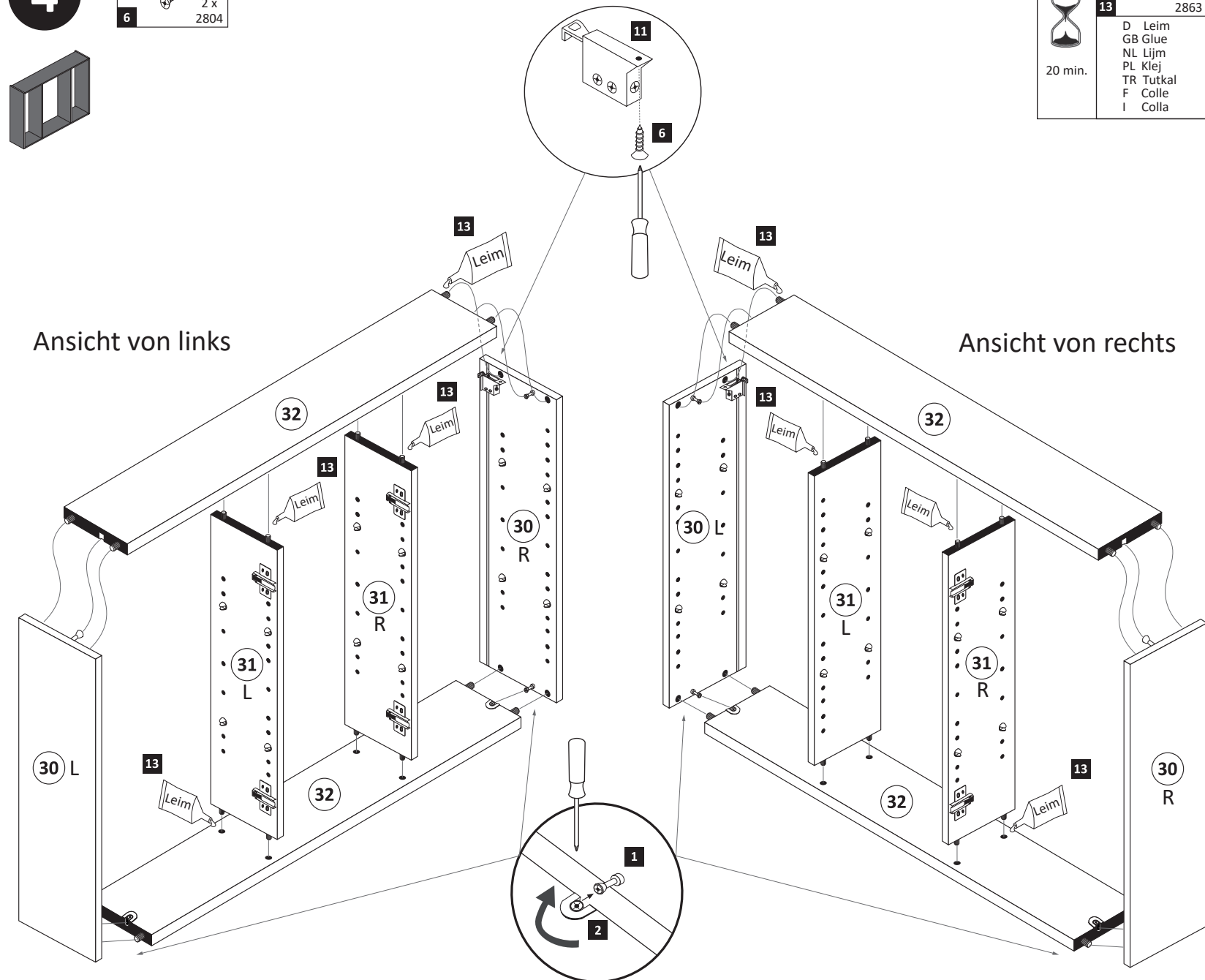

5

Bitte nur eine Variante auswählen und den entsprechenden Ausschnitt in einer Größe von maximal Trafobreite wie Trafohöhe - 10 mm aussägen. Trafomontage wird im Schritt 7 durchgeführt.

Variante 1: Trafomontage unten

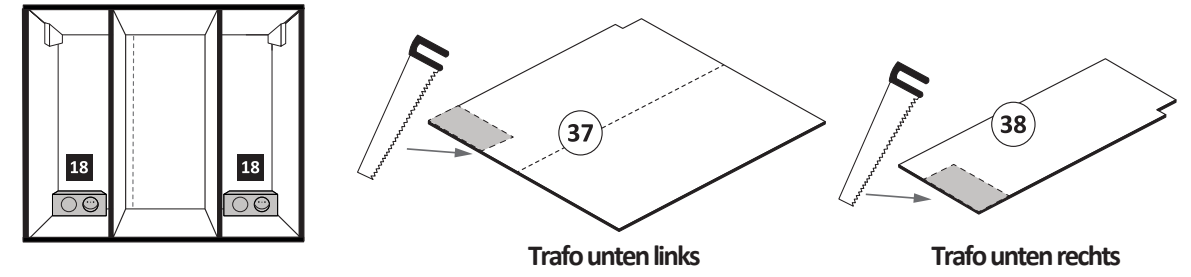

Variante 2: Trafomontage oben

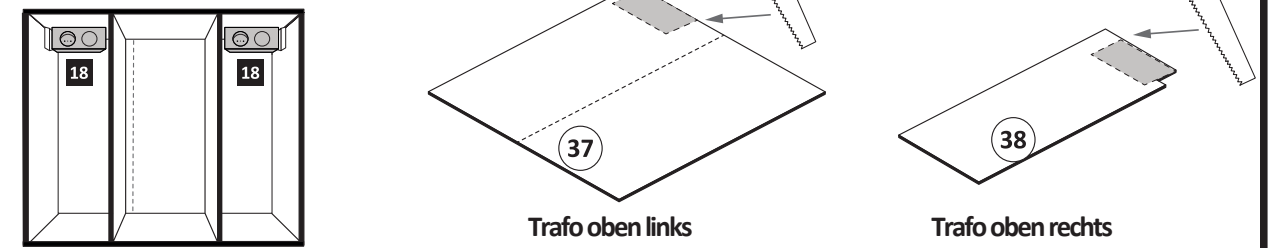

6

- 16 3,5 x 17 2832
- 17 6 x 2552

ACHTUNG !
Folgende Montageschritte mit dem Beispiel „Trafomontage Variante unten links“ !

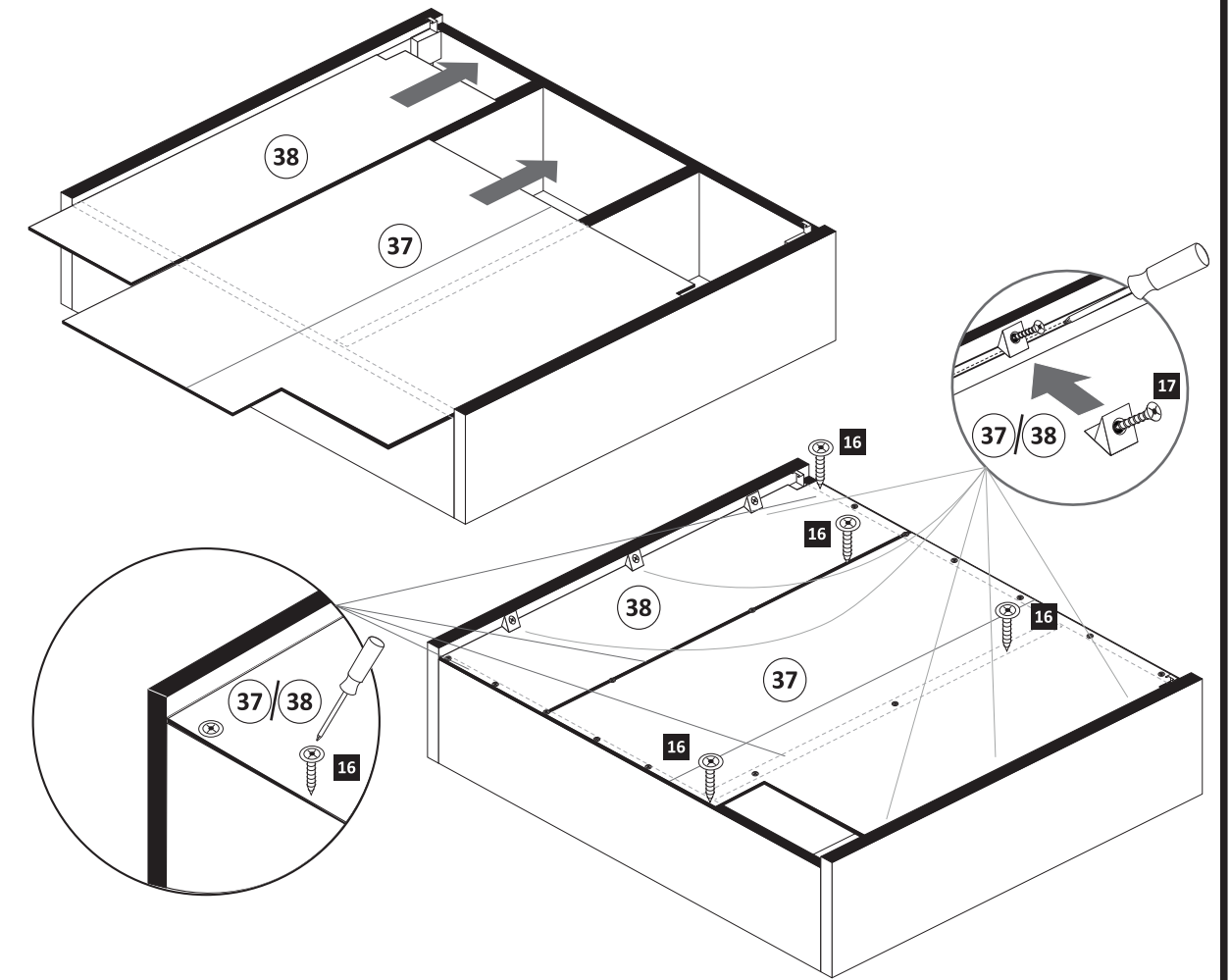

7

18 1x 2x

Achtung !!
Die Distanzhülsen sind optional im Lieferumfang.
Nur bei Bedarf nutzen.

8

33 34 33 34 33

10

35 36 36

Scharniermontage
1. 2.

Scharnier lösen 2. 1. (drücken)

9

gedämpft 3 x 1506 3
ungedämpft 3 x 1507 4
3,5 x 15 12 x 2804 6
6 x 2865 12

3 4 35 12 3 4 36 2 x 12

Scharnieransichten von unten

11

3 x 15 15 6 x 2803 21 3 x 1098 21

35 36 2 x 12

Unten

8 mm 21 15 5 mm

12

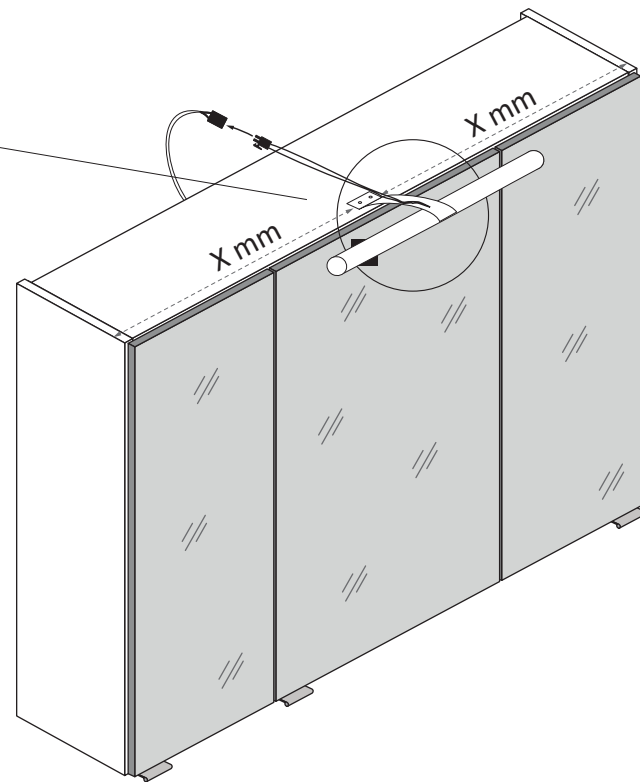
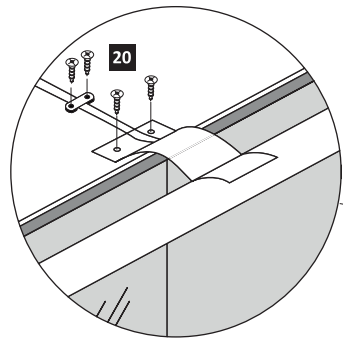
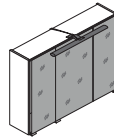
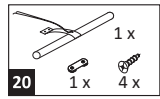

13

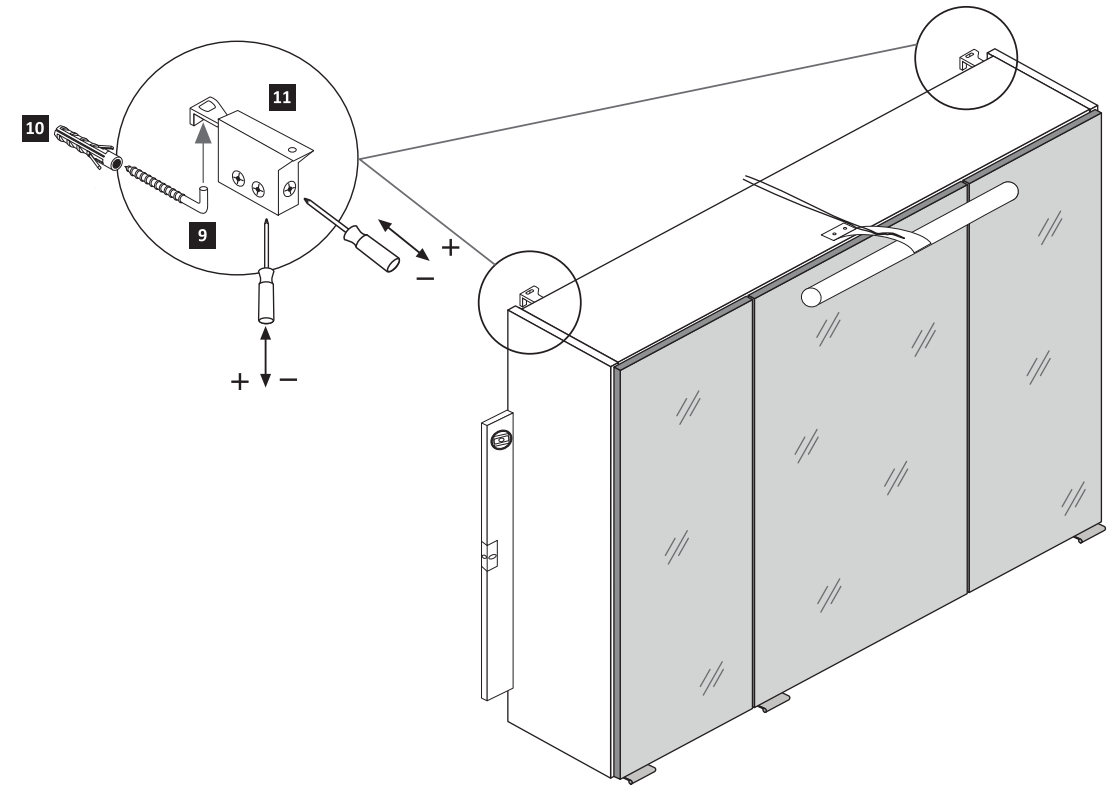
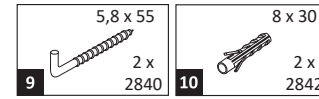

14

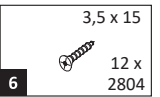

1. Türen einstellen.

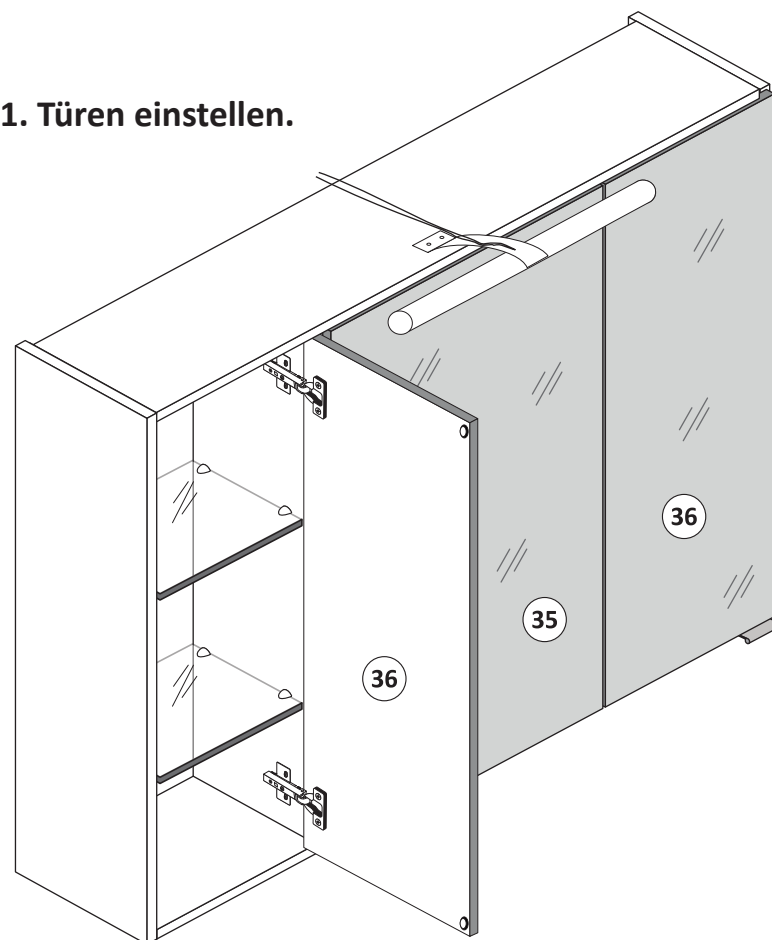
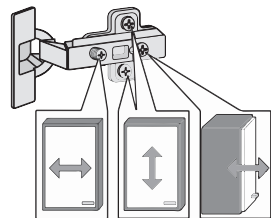

Achtung !!
Aus Sicherheitsgründen ist die Montage der Sicherungsschrauben zwingend notwendig. Nachdem montieren der Sicherungsschrauben ist die Höheneinstellung der Türen nicht mehr möglich!

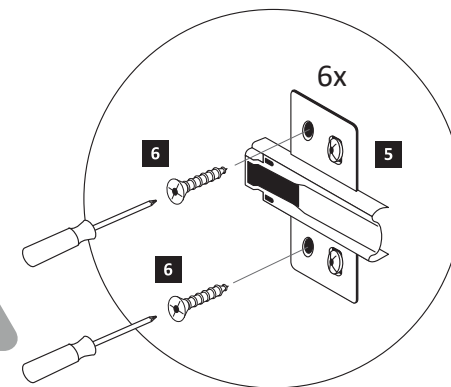

2. Sicherungsschrauben montieren.

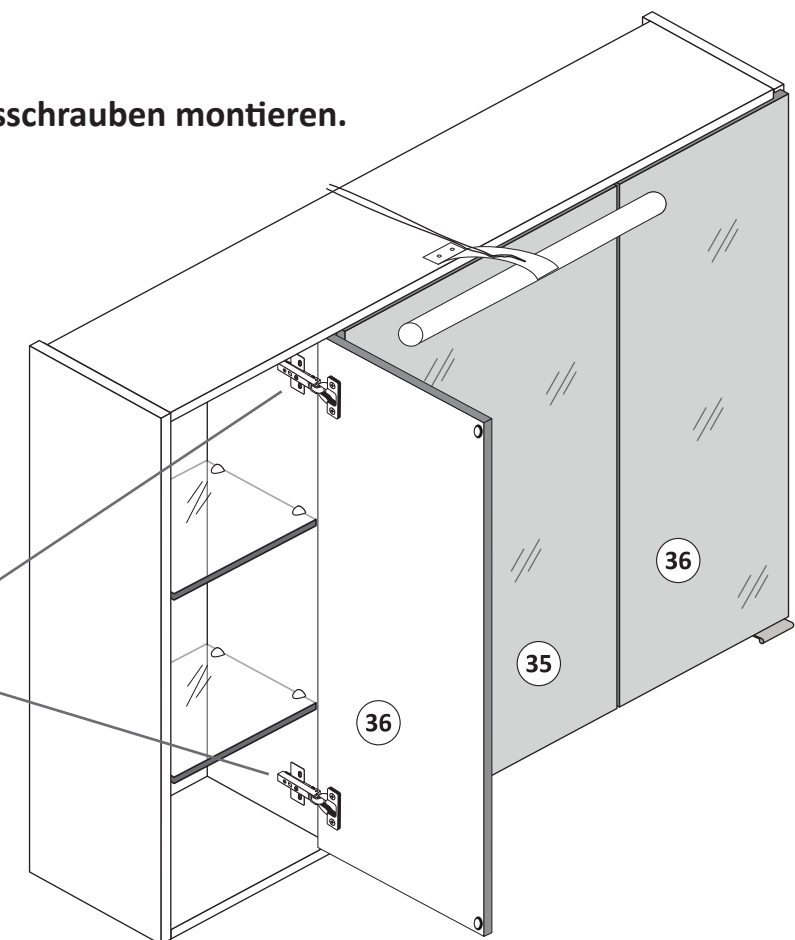



88084.531

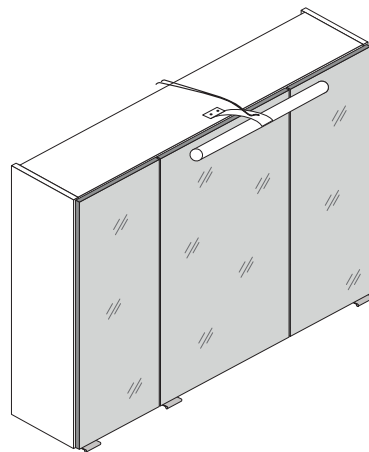

3D-Effekt

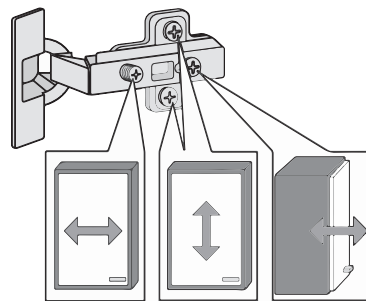
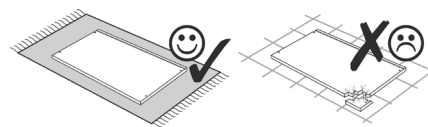
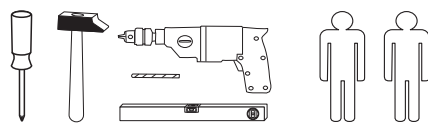
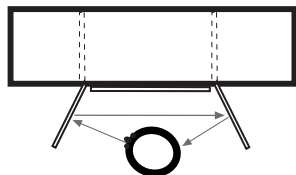

1 4 x 2802	2 4 x 2801	gedämpft 3 x 1506	ungedämpft 3 x 1507	6 x 1614
3,5 x 15 26 x 2804	8 x 30 16 x 2861	4 x 30 4 x 2812	5,8 x 55 2 x 2840	8 x 30 2 x 2842
11 2 x 2843	12 6 x 2865	Leim 1 x 2863	14 24 x 2819	15 3 x 15 6 x 2803
3,5 x 17 20 x 2832	17 6 x 2552	18 1 x 2 x	20 1 x 4 x	3 x 15 6 x 2803
21 3 x 1098				

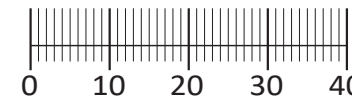

Das beigefügte Wandbefestigungsmaterial (Dübel und Schrauben) eignet sich nur für festes Mauerwerk (z.B.: Beton- oder Ziegelwände). Für andere Wandaufbauten sind eventuell Spezialdübel und andere Schrauben notwendig. Ziehen Sie gegebenenfalls eine Fachkraft zu Rate.

Приложенный материал для крепления к стене (дюбели и винты) пригоден только для жестких кладок (например, бетонные или кирпичные стены). Для других настенных конструкций необходимы смотря по обстоятельствам специальные дюбели и другие винты. При необходимости проконсультируйтесь у специалиста.

Załączony materiał do mocowania do ściany (kolki rozprężne i wkręty) nadaje się tylko do ścian murowanych (np. z betonu lub cegieł). Do ścian wykonanych w innych technologiach konieczne być mogą specjalne kolki rozprężne i inne wkręty. W razie potrzeby skorzystaj z fachowej pomocy.

The accompanying wall mounting hardware (anchors and screws) is suitable only for solid masonry (eg concrete or brick walls). For other wall structures are possibly special anchor bolts and other necessary. Tighten if necessary, an expert.

De begeleidende wandmontage hardware (pluggen en schroeven) is alleen geschikt voor massief metselwerk (bijvoorbeeld beton of bakstenen muren). Voor andere muur structuren zijn eventueel bijzondere ankerbouten en andere noodzakelijke. Draai indien nodig, een deskundige.

Le mur d'accompagnement matériel de montage (chevilles et les vis) ne convient que pour la maçonnerie solide (par exemple en béton ou des murs de briques). Pour les structures de mur d'autres sont peut-être spéciale boulons d'ancrage et d'autres nécessaires. Serrer le cas échéant, un expert.

Il muro di accompagnamento hardware di montaggio (tasselli e viti) è'e adatto solo per muratura piena (ad esempio calcestruzzo o muratura). Per le altre strutture murarie sono forse speciali bulloni di ancoraggio e necessari di altri. Serrare se necessario, un esperto.

Ekteki duvara sabit montaj malzemeleri (dübel ve vidalar), sadece sağlam duvarlar için (örnek: beton veya tuğla) elverişlidir. Başka duvarlar için özel dübeller ve farklı vidalar gerekebilir. Gerekliğinde bir uzmana danışınız.

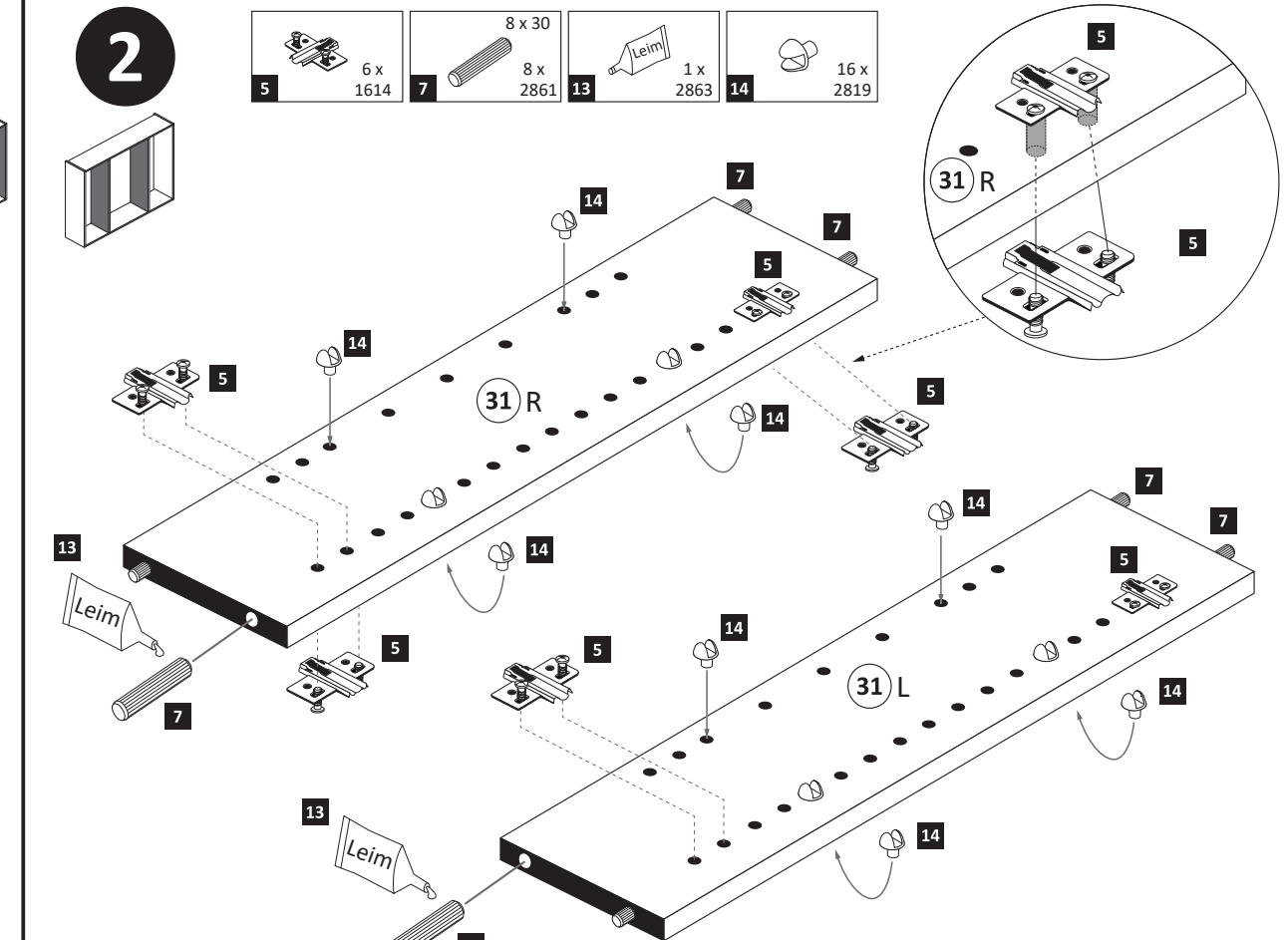
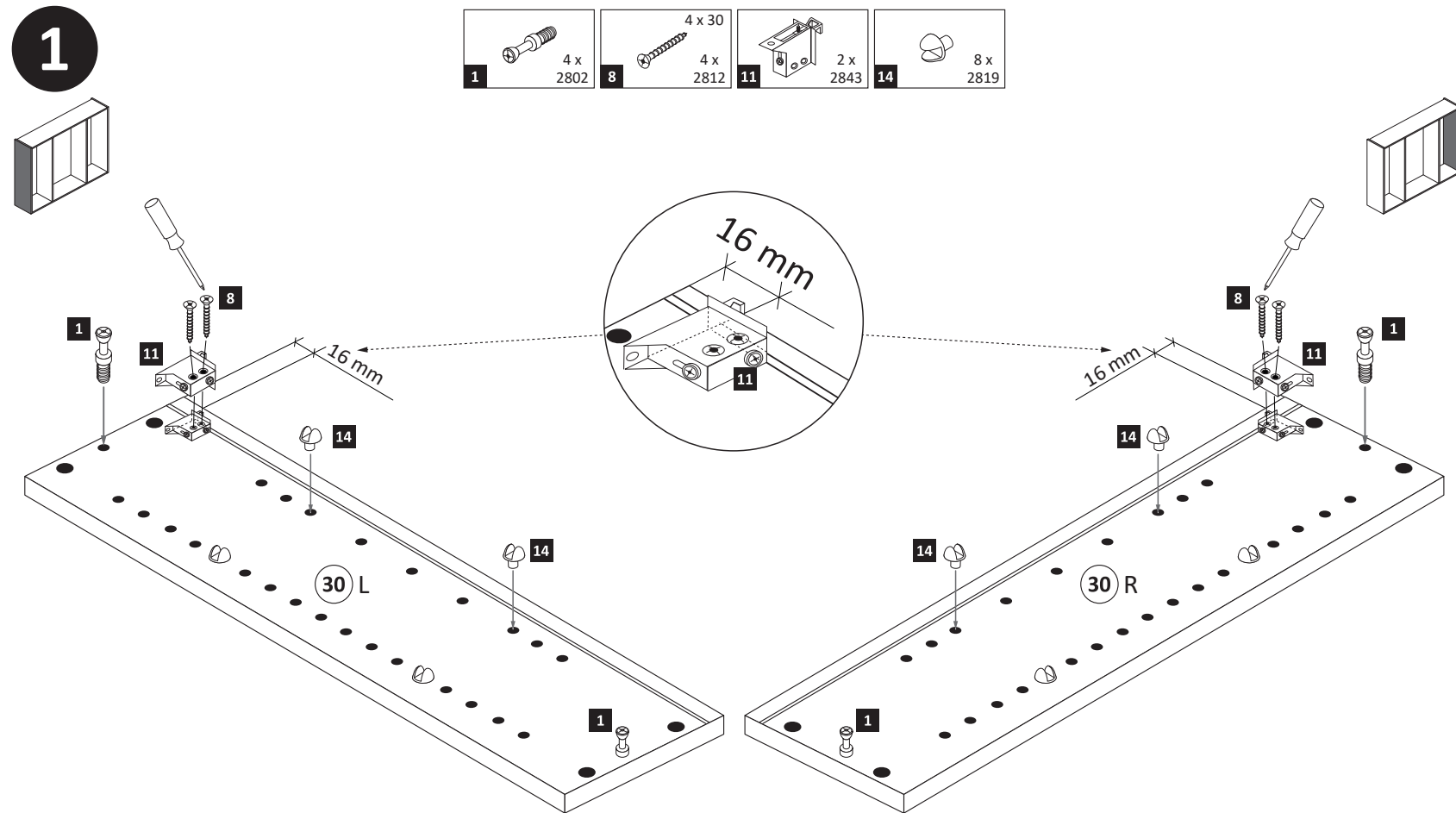
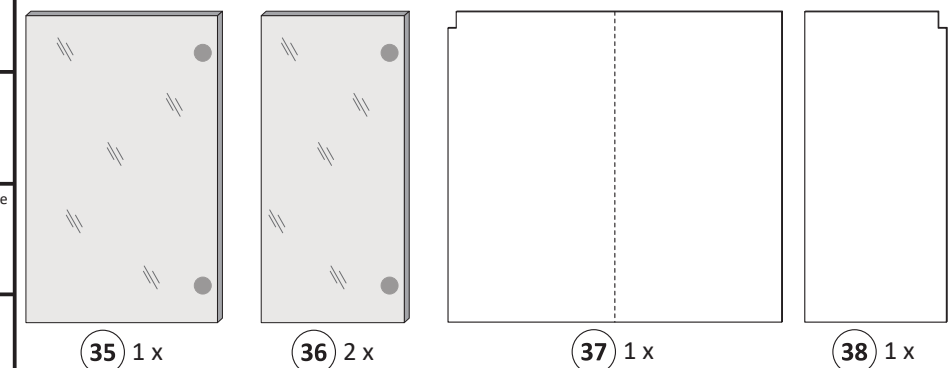
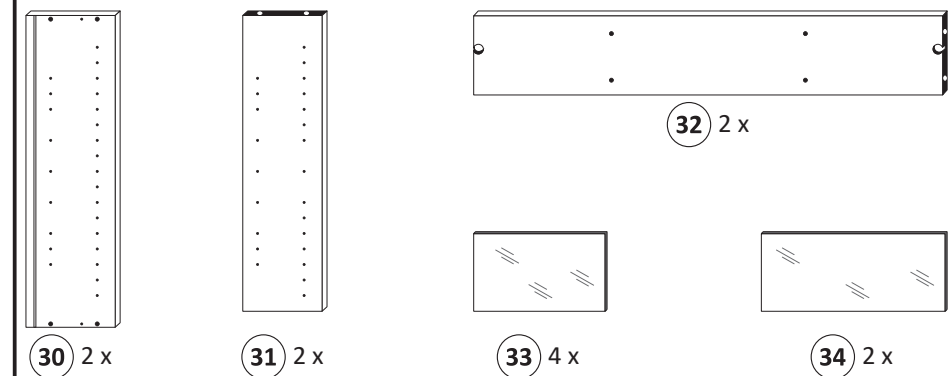

3

- 2 4 x 2801
- 7 8 x 30 2861
- 13 1 x 2863

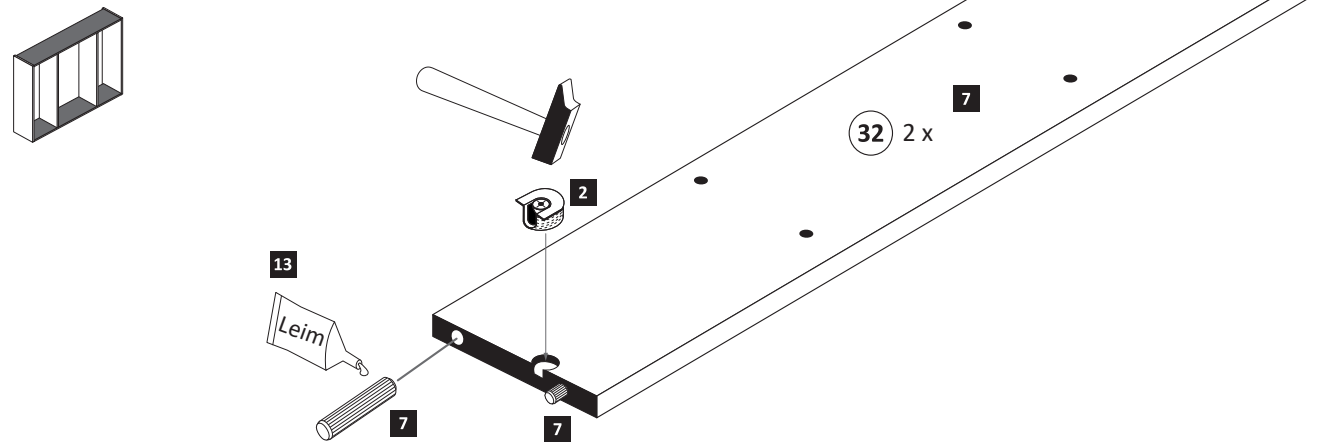

4

- 6 3,5 x 15 2804

- 13 1 x 2863
- 20 min.
- D Leim
 - GB Glue
 - NL Lijm
 - PL Klej
 - TR Tutkal
 - F Colle
 - I Colla

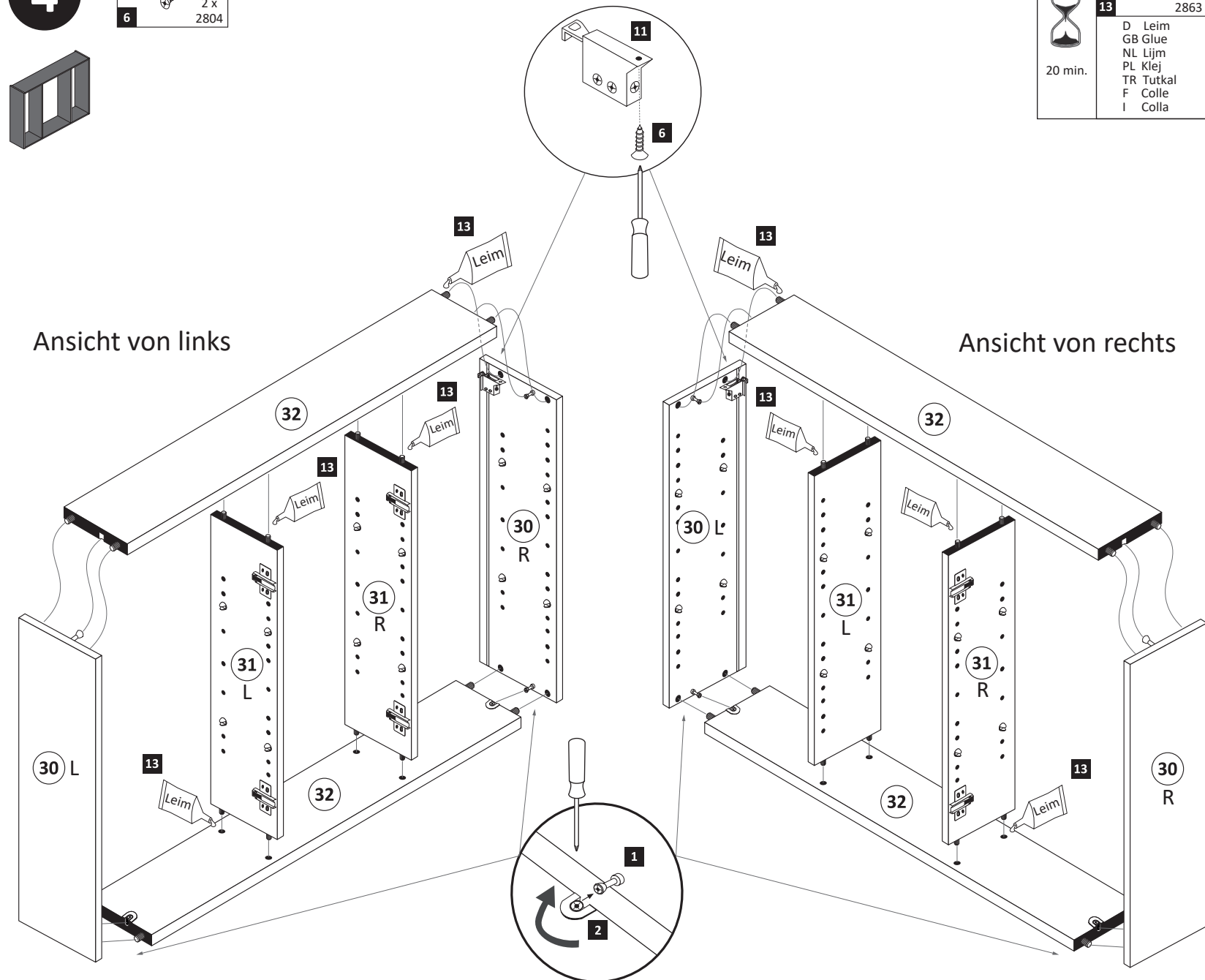

5

Bitte nur eine Variante auswählen und den entsprechenden Ausschnitt in einer Größe von maximal Trafobreite wie Trafohöhe - 10 mm aussägen. Trafomontage wird im Schritt 7 durchgeführt.

Variante 1: Trafomontage unten

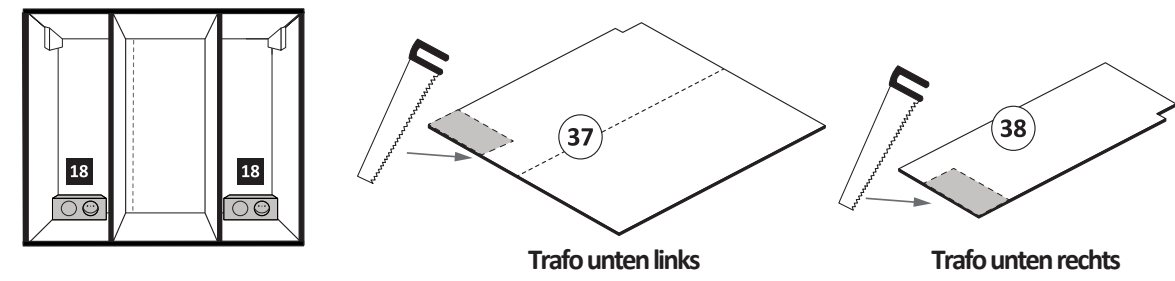

Variante 2: Trafomontage oben

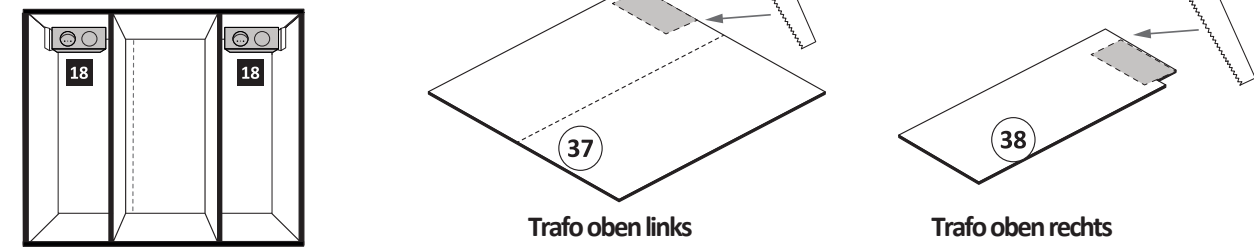

6

- 16 3,5 x 17 2832
- 17 6 x 2552

ACHTUNG !
Folgende Montageschritte mit dem Beispiel „Trafomontage Variante unten links“ !

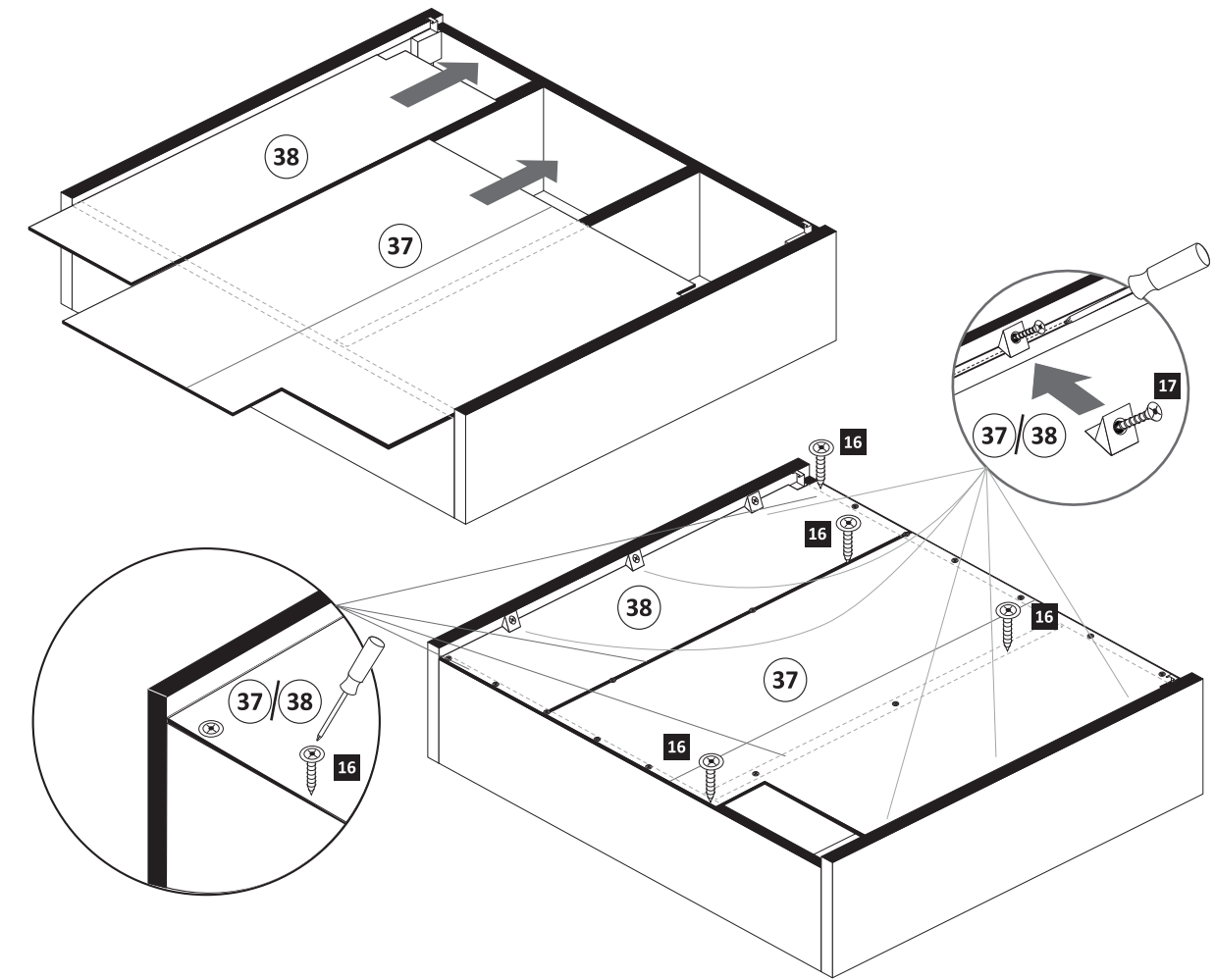

7

18 1x 2x

Achtung !!
Die Distanzhülsen sind optional im Lieferumfang.
Nur bei Bedarf nutzen.

8

33 34 33 34 33

10

35 36 36

Scharniermontage
1. 2.

Scharnier lösen 2. 1. (drücken)

9

gedämpft 3 x 1506 3
ungedämpft 3 x 1507 4
3,5 x 15 12 x 2804 6
6 x 2865 12

3 4 6 12 35 36 2 x 12

Scharnieransichten von unten

11

3 x 15 15 6 x 2803 21 3 x 1098

35 21 15 21 15 8 mm 5 mm

Unten

12

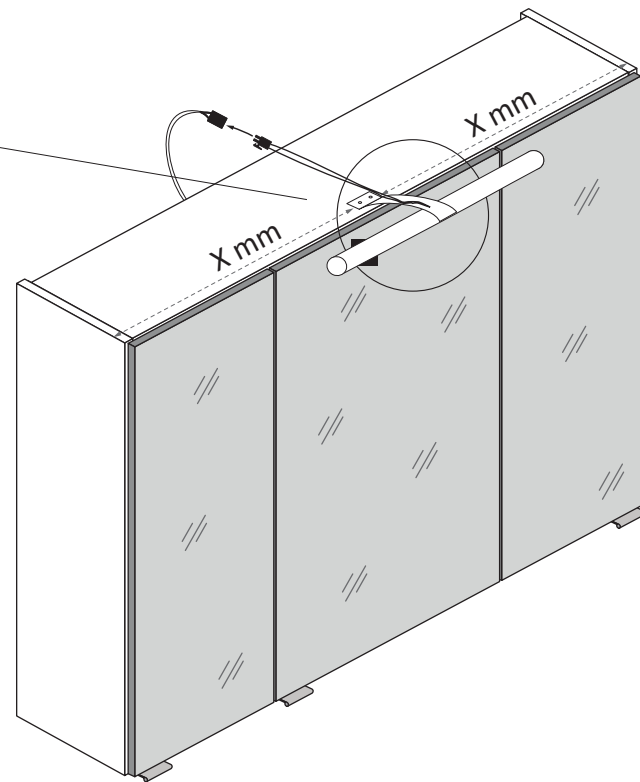
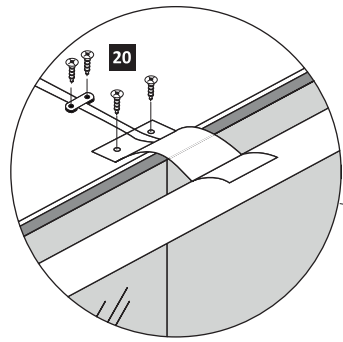
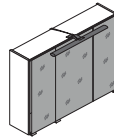
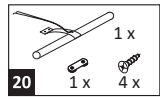

13

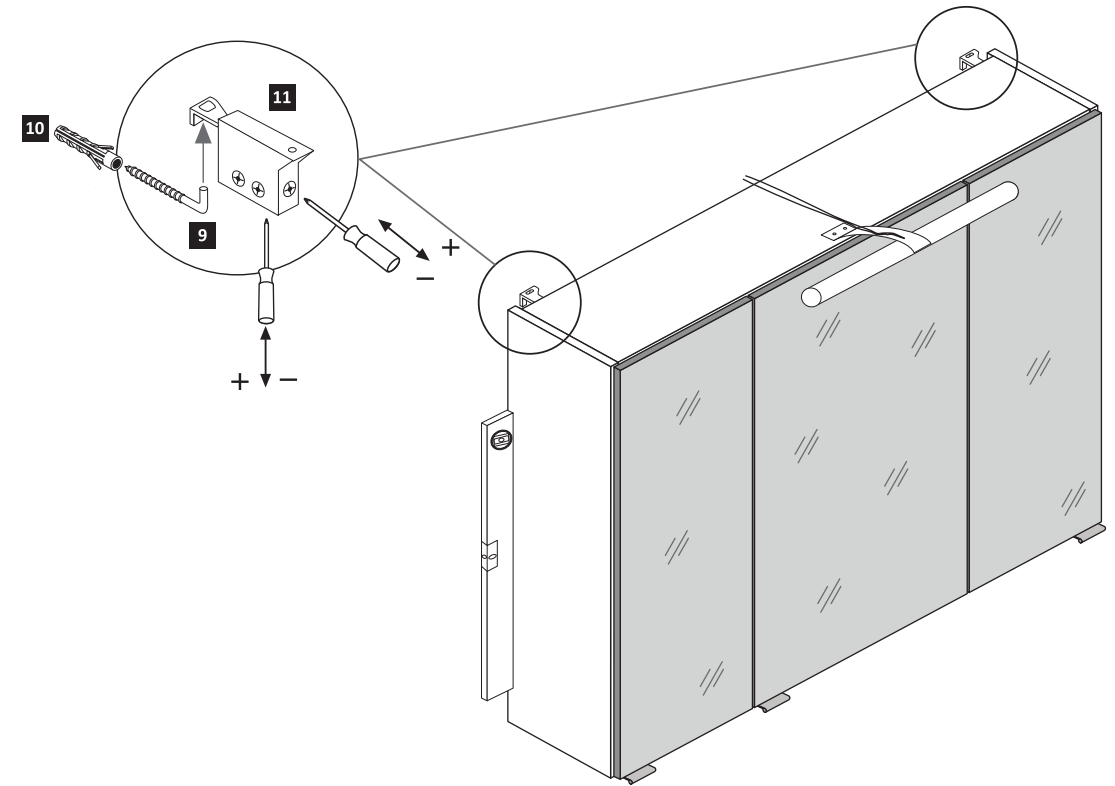
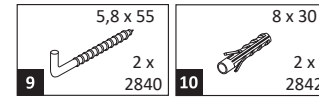

14

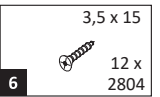

1. Türen einstellen.

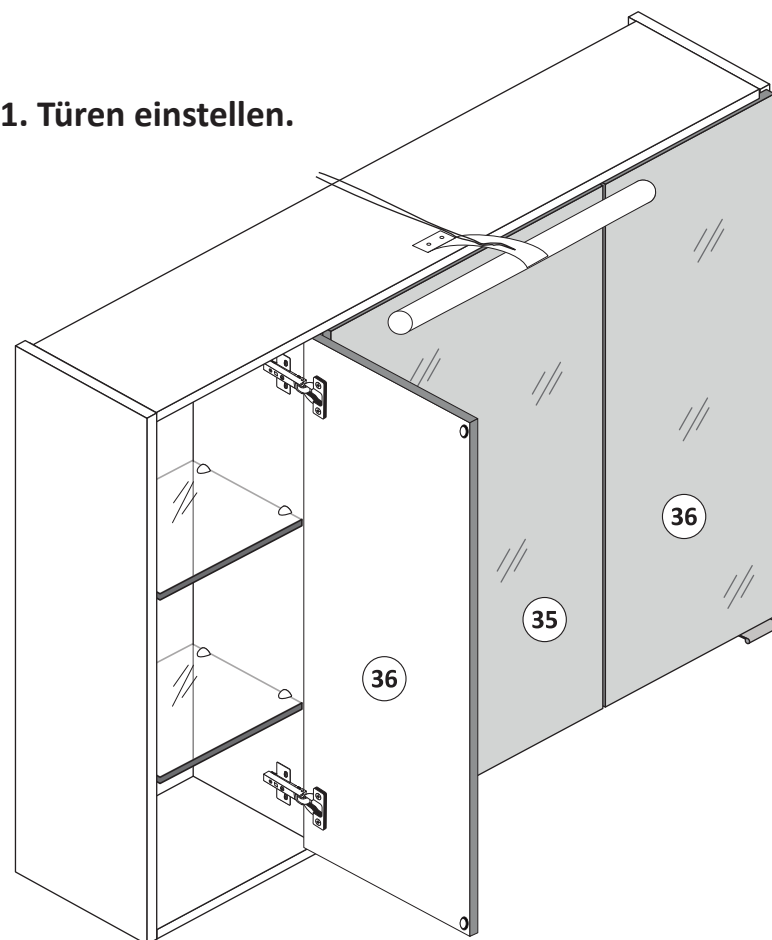
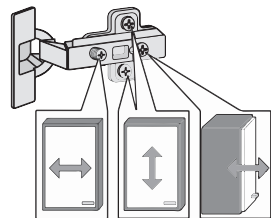

Achtung !!
Aus Sicherheitsgründen ist die Montage der Sicherungsschrauben zwingend notwendig. Nachdem montieren der Sicherungsschrauben ist die Höheneinstellung der Türen nicht mehr möglich!

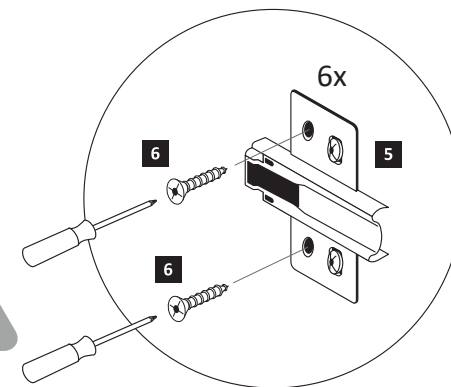

2. Sicherungsschrauben montieren.

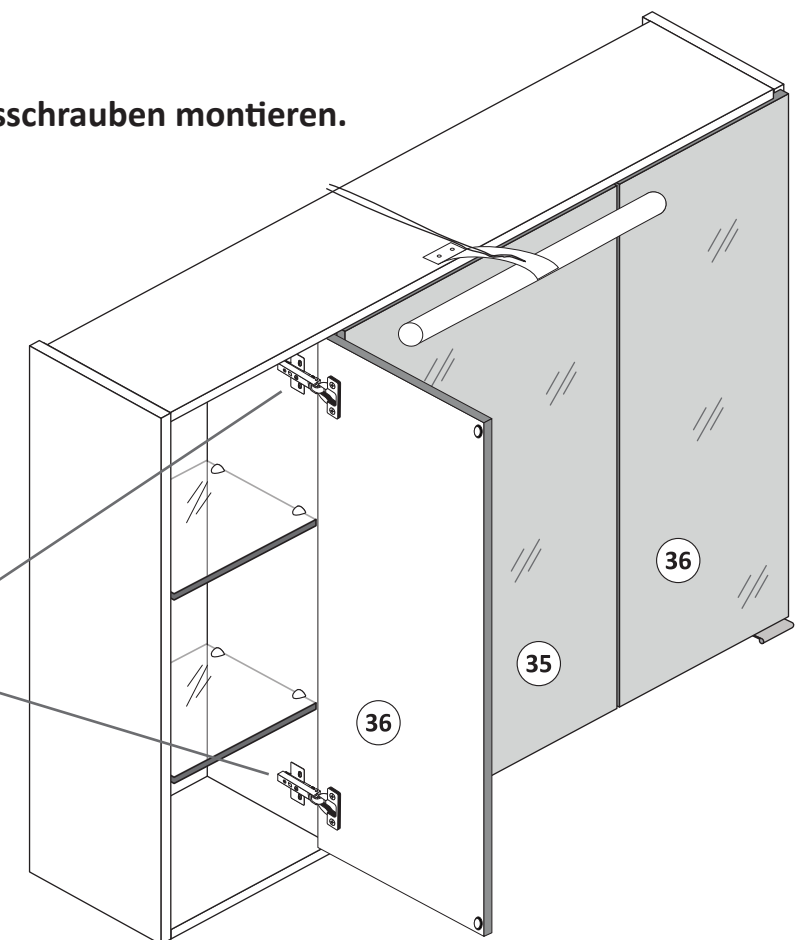



88084.531



3D-Effekt



1 4 x 2802	2 4 x 2801	gedämpft 3 x 1506	ungedämpft 3 x 1507	6 x 1614
3,5 x 15 26 x 2804	8 x 30 16 x 2861	4 x 30 4 x 2812	5,8 x 55 2 x 2840	8 x 30 2 x 2842
11 2 x 2843	12 6 x 2865	Leim 1 x 2863	14 24 x 2819	15 3 x 15 6 x 2803
3,5 x 17 20 x 2832	17 6 x 2552	18 1 x 2 x	20 1 x 4 x	1 x
21 3 x 1098				

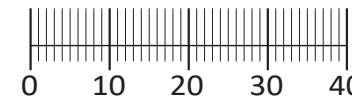

Das beigefügte Wandbefestigungsmaterial (Dübel und Schrauben) eignet sich nur für festes Mauerwerk (z.B.: Beton- oder Ziegelwände). Für andere Wandaufbauten sind eventuell Spezialdübel und andere Schrauben notwendig. Ziehen Sie gegebenenfalls eine Fachkraft zu Rate.

Приложенный материал для крепления к стене (дюбели и винты) пригоден только для жестких кладок (например, бетонные или кирпичные стены). Для других настенных конструкций необходимы смотря по обстоятельствам специальные дюбели и другие винты. При необходимости проконсультируйтесь у специалиста.

Załączony materiał do mocowania do ściany (kolki rozprężne i wkręty) nadaje się tylko do ścian murowanych (np. z betonu lub cegieł). Do ścian wykonanych w innych technologiach konieczne być mogą specjalne kolki rozprężne i inne wkręty. W razie potrzeby skorzystaj z fachowej pomocy.

The accompanying wall mounting hardware (anchors and screws) is suitable only for solid masonry (eg concrete or brick walls). For other wall structures are possibly special anchor bolts and other necessary. Tighten if necessary, an expert.

De begeleidende wandmontage hardware (pluggen en schroeven) is alleen geschikt voor massief metselwerk (bijvoorbeeld beton of bakstenen muren). Voor andere muur structuren zijn eventueel bijzondere ankerbouten en andere noodzakelijke. Draai indien nodig, een deskundige.

Le mur d'accompagnement matériel de montage (chevilles et les vis) ne convient que pour la maçonnerie solide (par exemple en béton ou des murs de briques). Pour les structures de mur d'autres sont peut-être spéciale boulons d'ancrage et d'autres nécessaires. Serrer le cas échéant, un expert.

Il muro di accompagnamento hardware di montaggio (tasselli e viti) è'e adatto solo per muratura piena (ad esempio calcestruzzo o muratura). Per le altre strutture murarie sono forse speciali bulloni di ancoraggio e necessari di altri. Serrare se necessario, un esperto.

Ekteki duvara sabit montaj malzemeleri (dübel ve vidalar), sadece sağlam duvarlar için (örnek: beton veya tuğla) elverişlidir. Başka duvarlar için özel dübeller ve farklı vidalar gerekebilir. Gerektiğinde bir uzmana danışınız.

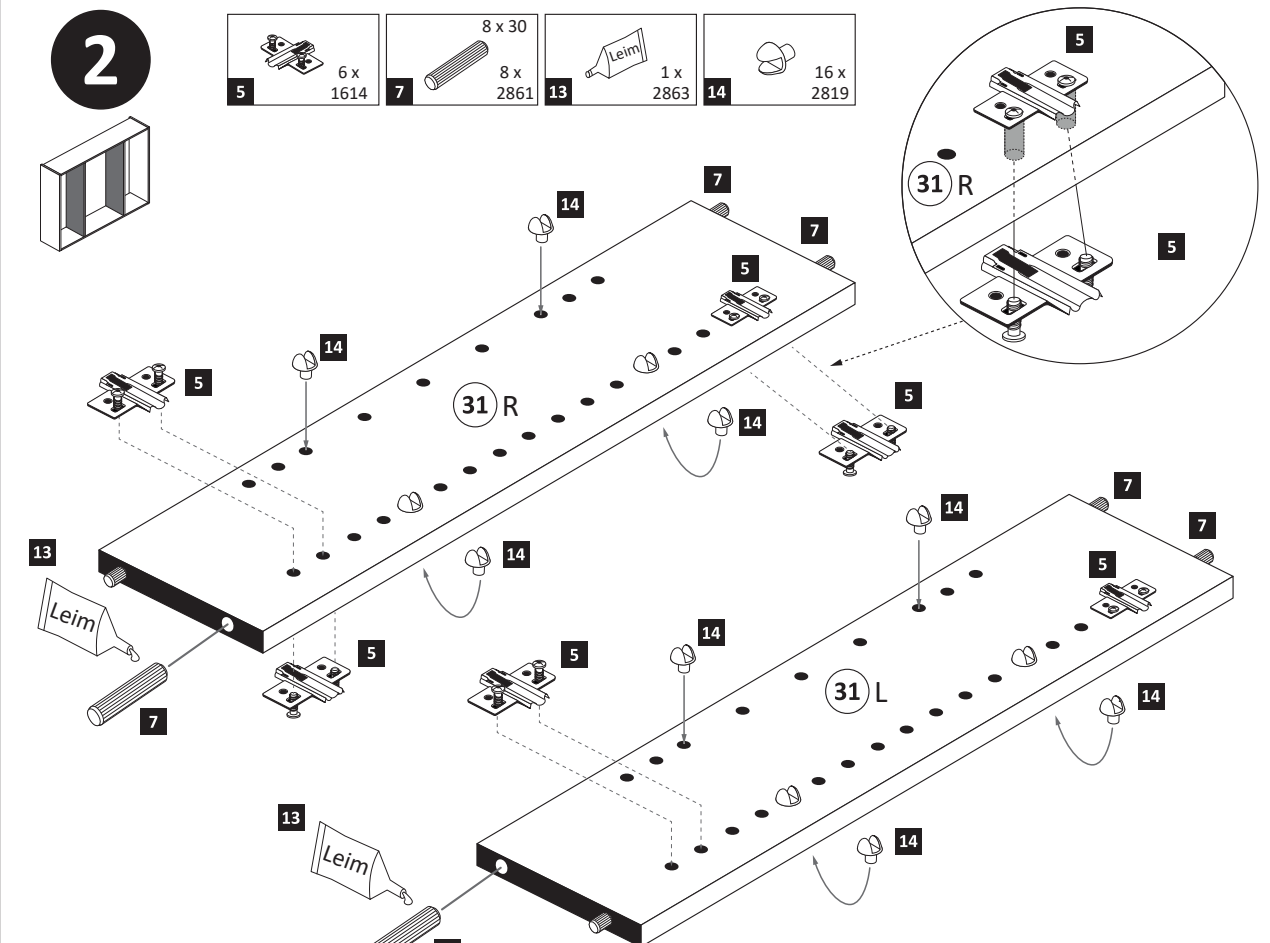
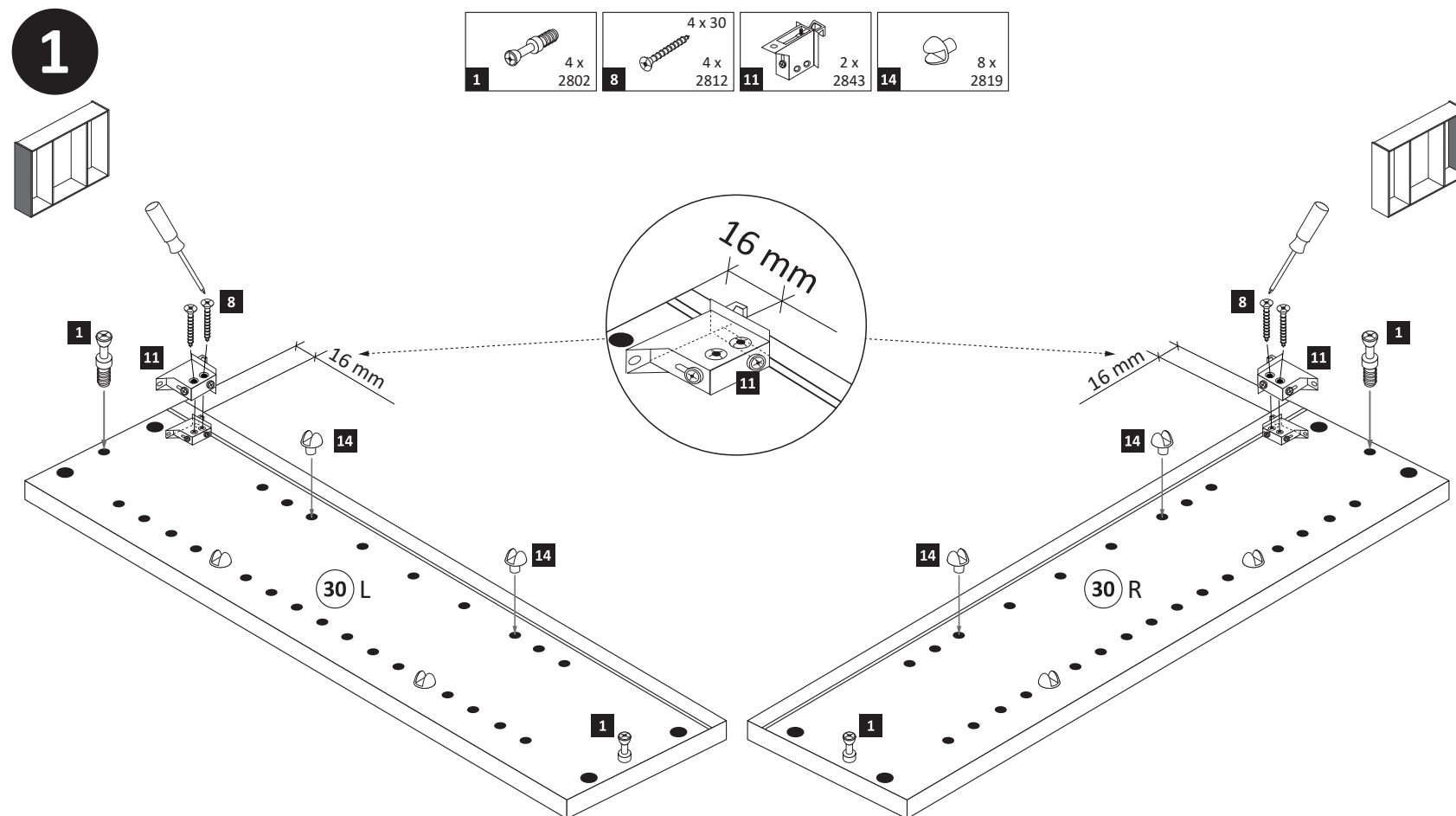
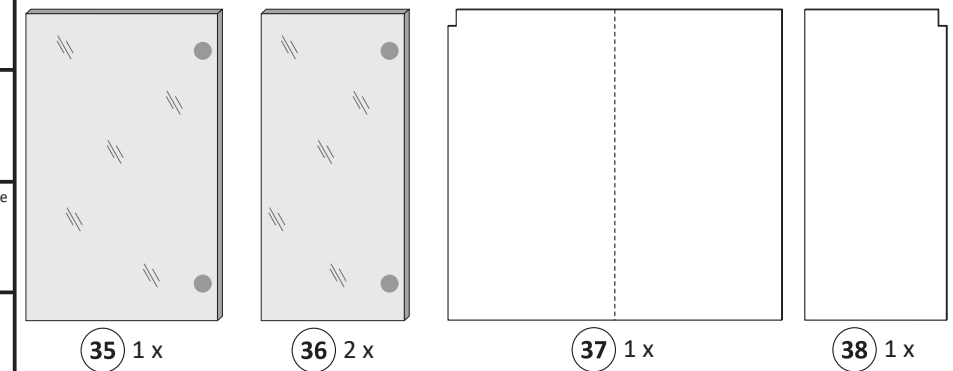
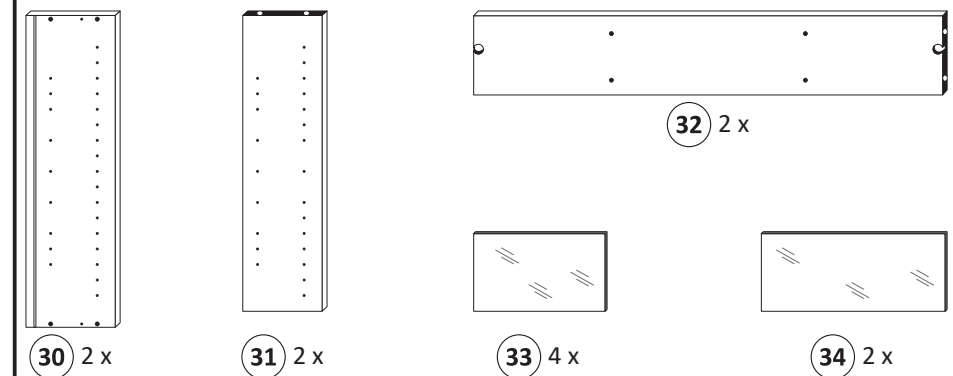

3

- 2** 4 x 2801
- 7** 8 x 30 2861
- 13** 1 x 2863

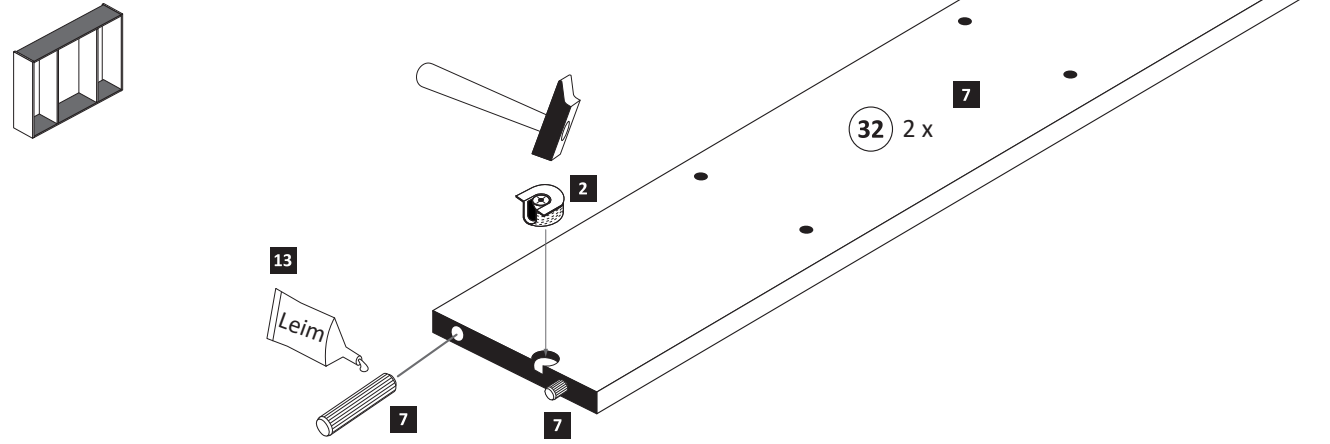

4

- 6** 2 x 2804
- 3,5 x 15

- 13** 1 x 2863
- 20 min.
- D Leim
- GB Glue
- NL Lijm
- PL Klej
- TR Tutkal
- F Colle
- I Colla

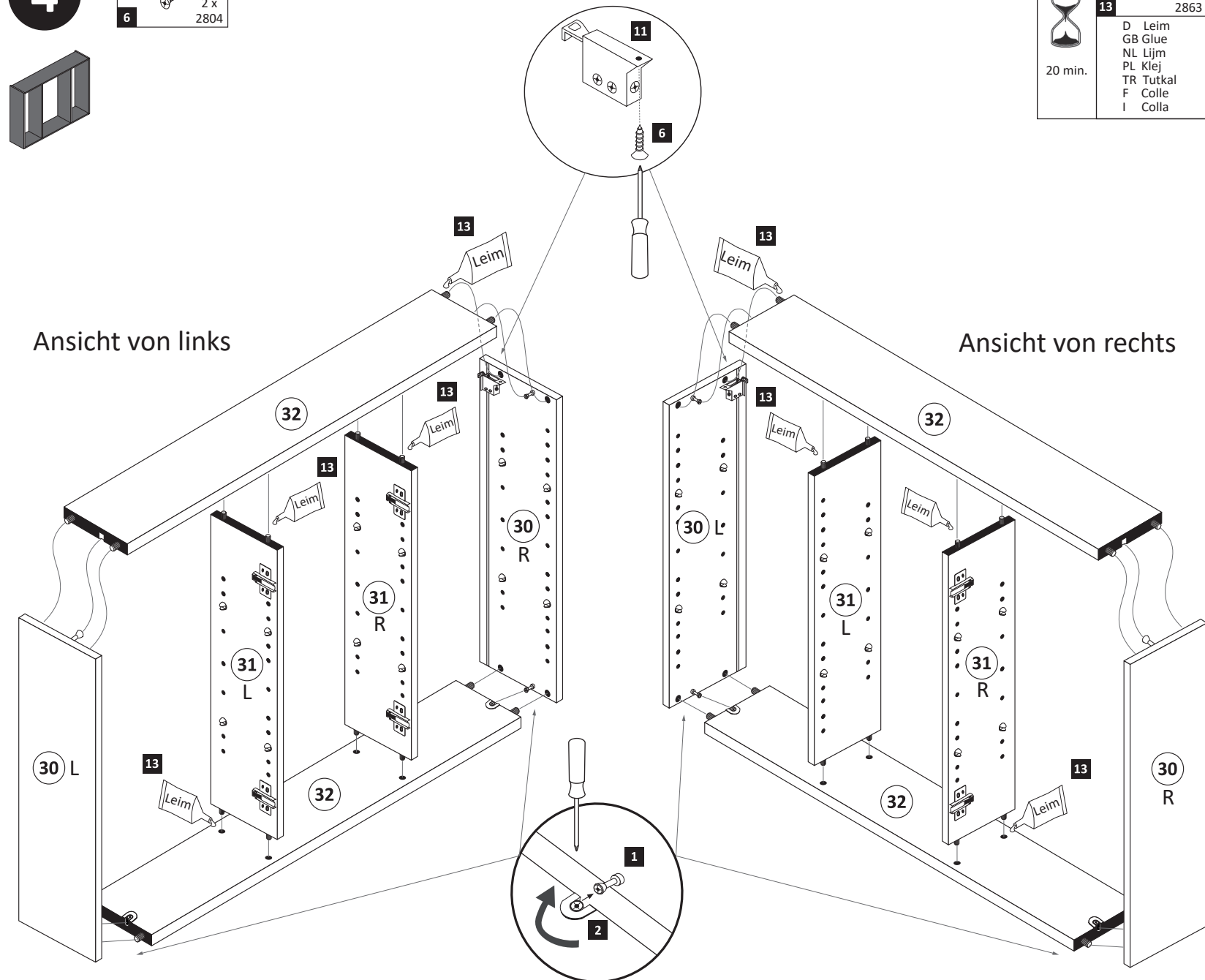

5

Bitte nur eine Variante auswählen und den entsprechenden Ausschnitt in einer Größe von maximal Trafobreite wie Trafohöhe - 10 mm aussägen. Trafomontage wird im Schritt **7** durchgeführt.

Variante 1: Trafomontage unten

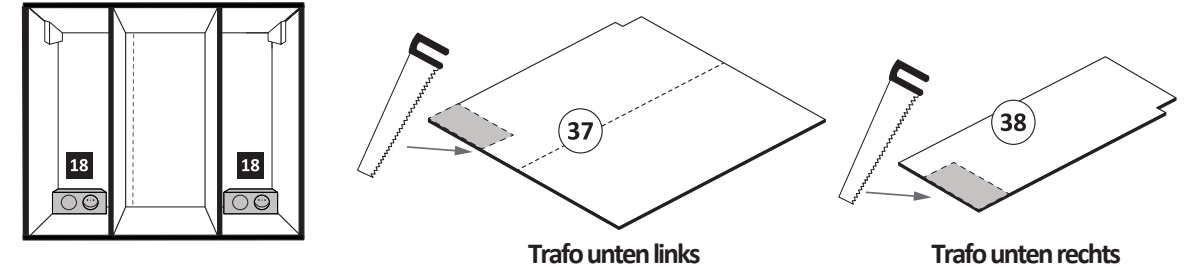

Variante 2: Trafomontage oben

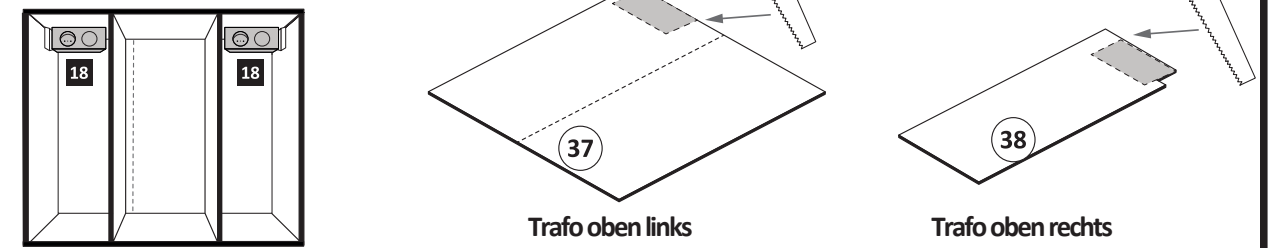

6

- 16** 20 x 2832
- 17** 6 x 2552
- 3,5 x 17

ACHTUNG !
Folgende Montageschritte mit dem Beispiel „Trafomontage Variante unten links“ !

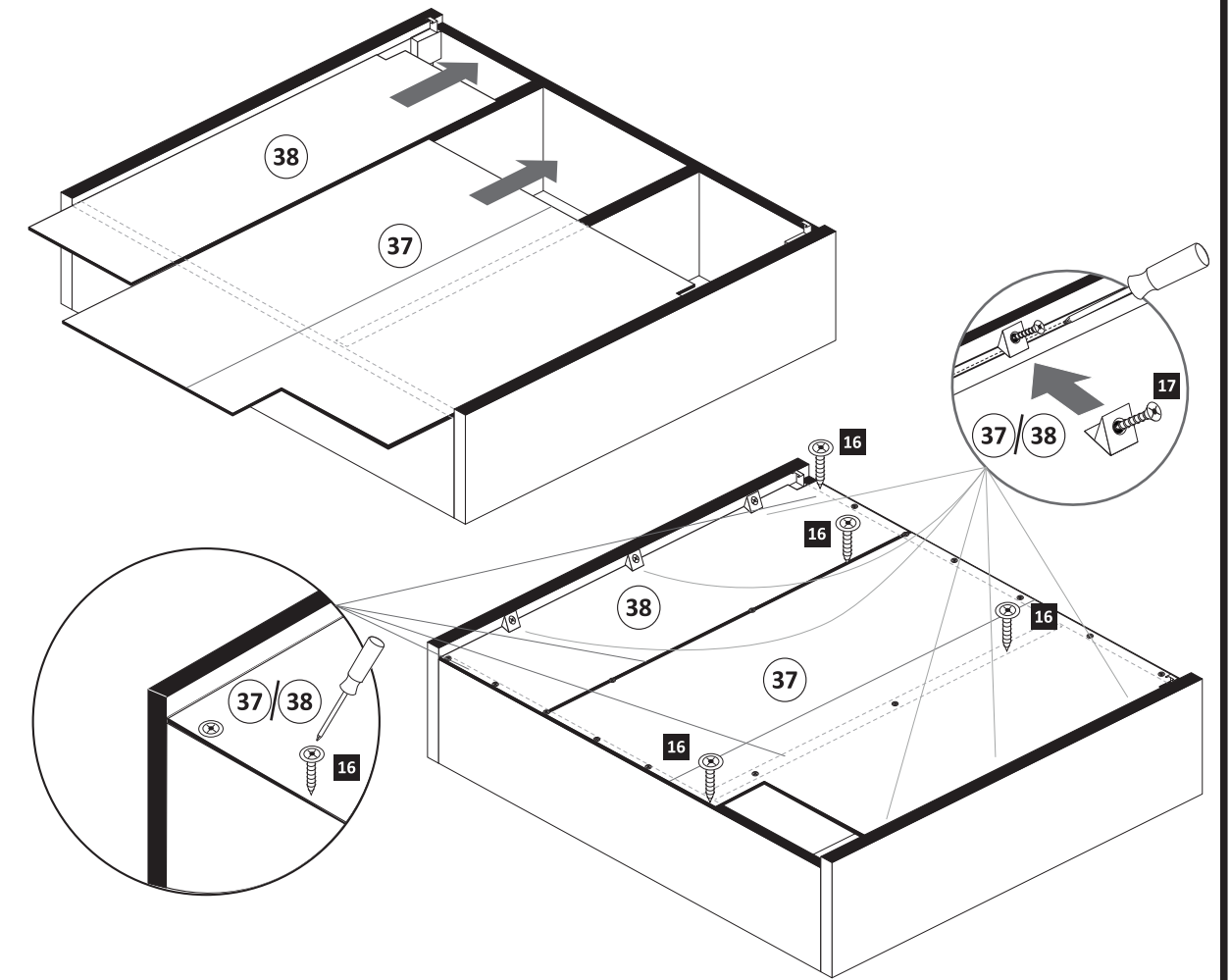

7

18 1x 2x

Achtung !!
Die Distanzhülsen
sind optional im
Lieferumfang.
Nur bei Bedarf nutzen.

8

33 34 33 34 33

10

35 36 36

Scharniermontage
1. 2.

Scharnier lösen 2. 1. (drücken)

9

gedämpft 3 x 1506 3
ungedämpft 3 x 1507 4
3,5 x 15 12 x 2804 6
6 x 2865 12

3 4 35 12 3 4 36 2 x 12

Scharnieransichten von unten

11

3 x 15 15 6 x 2803 21 3 x 1098

35 36 36

Unten

8 mm 21 15 5 mm

12

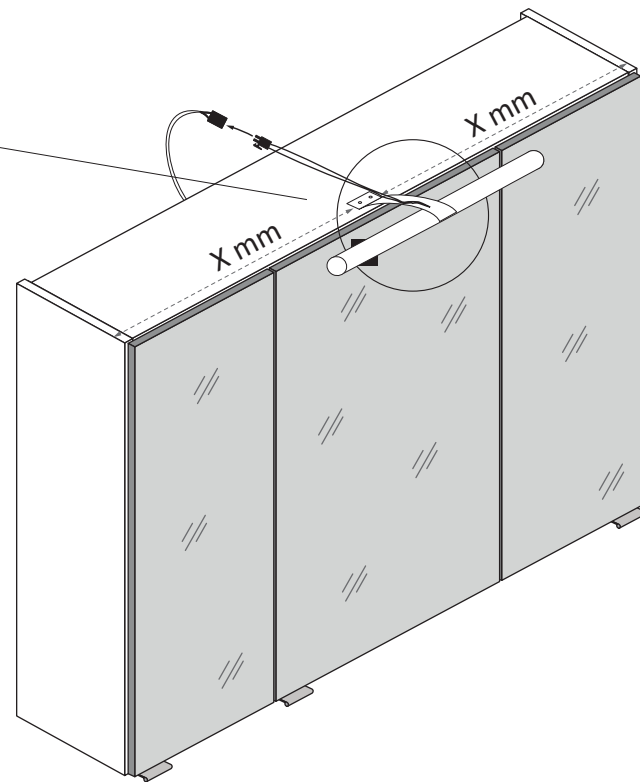
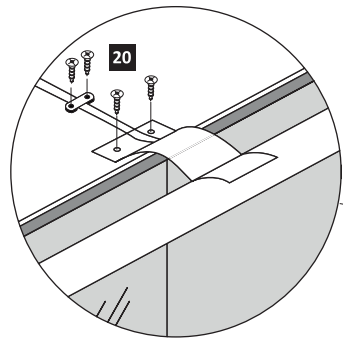
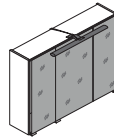
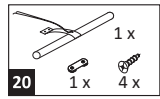

13

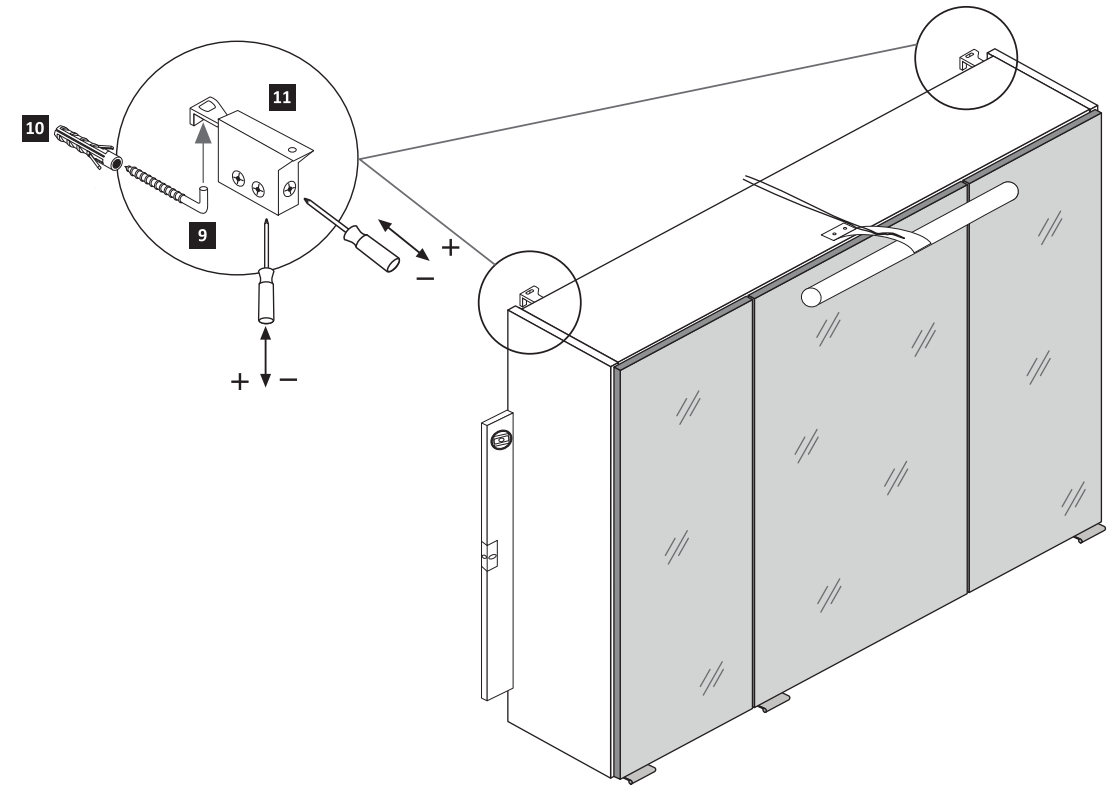
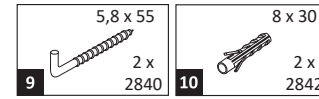

14

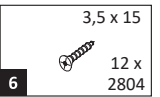

1. Türen einstellen.

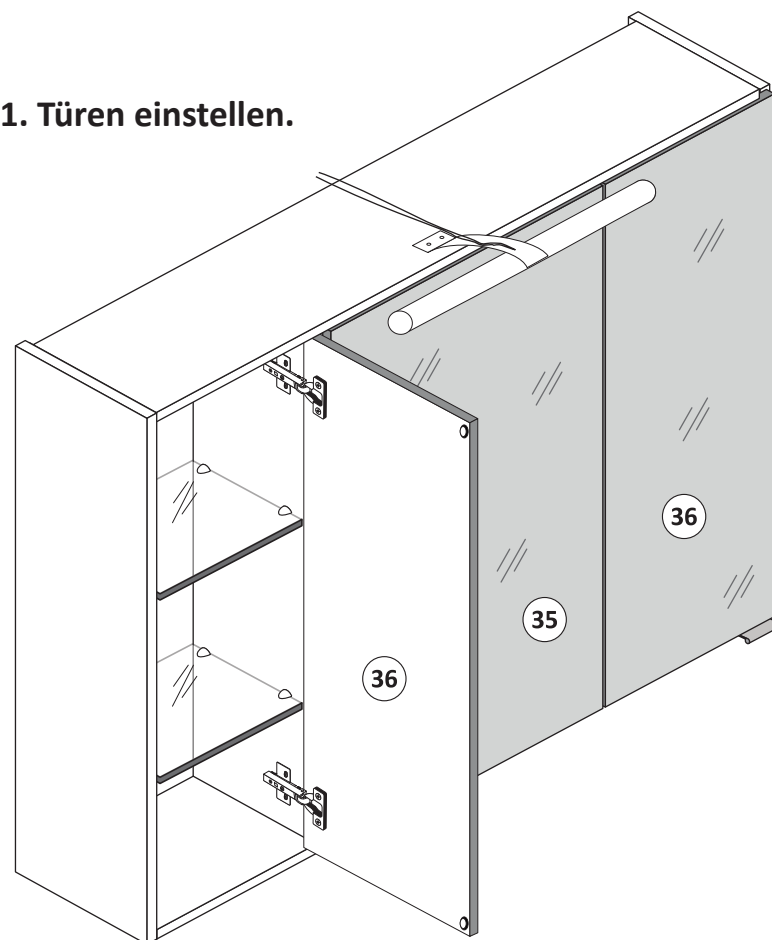
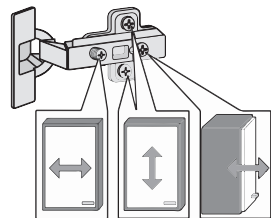

Achtung !!
Aus Sicherheitsgründen ist die Montage der Sicherungsschrauben zwingend notwendig. Nachdem montieren der Sicherungsschrauben ist die Höheneinstellung der Türen nicht mehr möglich!

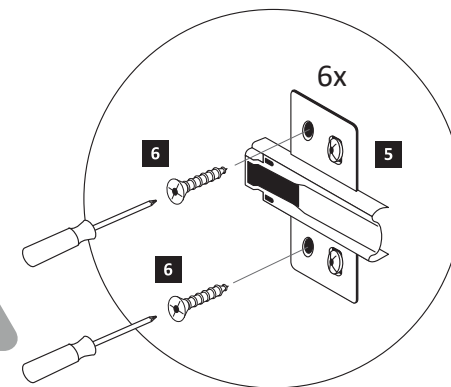

2. Sicherungsschrauben montieren.

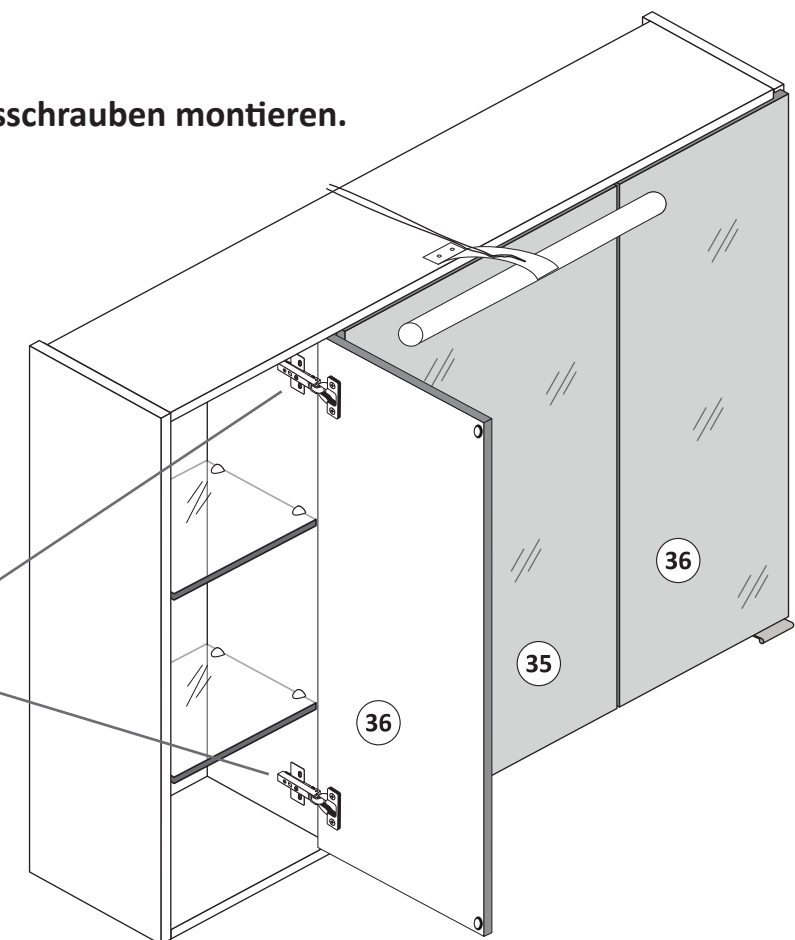



D

Wichtige Sicherheitshinweise

Die Installation Ihrer neuen Leuchte darf ausschließlich von autorisierten Fachpersonen durchgeführt werden.



www.till-hilft.de

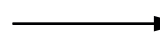

Montagehilfen



PL

Ważne wskazówki dotyczące bezpieczeństwa

Ta instalację nowej lampy mogą przeprowadzać wyłącznie autoryzowani instalatorzy



www.till-hilft.de

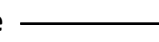

Montagehilfen



GB

Important safety instructions

The installation of your new luminaire may only be carried out by authorized specialists.



www.till-hilft.de

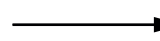

Montagehilfen



SK

Dôležité bezpečnostné upozornenia

Inštaláciu lampy smú vykonať výhradne autorizovaní



www.till-hilft.de

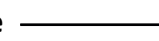

Montagehilfen



FR

signes de sécurité importantes

La L'installation votre nouveau luminaire doit uniquement être réalisée par des spécialistes autorisés



www.till-hilft.de



Montagehilfen



HU

Fontos biztonsági utmutatások

Az On Új lámpájának beszerelését kizárólag hivatalos szakember végezheti el



www.till-hilft.de



Montagehilfen



IT

Important disposizioni di sicurezza

L'installazione della il loro nuovo lampada può essere eseguita solo ed esclusivamente da personale tecnico autorizzato.



www.till-hilft.de

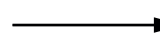

Montagehilfen



RO

Instrucțiuni de siguranță importante

Instalarea noii dumneavoastră lămpi este permisă exclusiv specialișilor autorizați



www.till-hilft.de

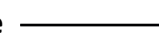

Montagehilfen



NL

Belangrijke veiligheidsaanwijzingen

De installatie van de nieuwe lamp moet worden uitgevoerd door vakbekwame personen worden uitgevoerd.



www.till-hilft.de



Montagehilfen



TR

Önemli güvenlik uyarıları

Yeni lamba montajı yetkin kişiler tarafından yapılmalıdır



www.till-hilft.de



Montagehilfen



CZ

Důležité bezpečnostní pokyny

Instalaci nových svídel smí provádět pouze kvalifikovaný elektrikář



www.till-hilft.de

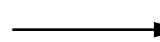

Montagehilfen



RU

важная информация по технике безопасности

Установка вашей новой лампы должна выполняться квалифицированным персоналом



www.till-hilft.de

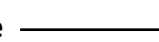

Montagehilfen



89904.330



D

Wichtige Sicherheitshinweise

Die Installation Ihrer neuen Leuchte darf ausschließlich von autorisierten Fachpersonen durchgeführt werden.



www.till-hilft.de

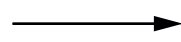

Montagehilfen



PL

Ważne wskazówki dotyczące bezpieczeństwa

Ta instalację nowej lampy mogą przeprowadzać wyłącznie autoryzowani instalatorzy



www.till-hilft.de

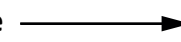

Montagehilfen



GB

Important safety instructions

The installation of your new luminaire may only be carried out by authorized specialists.



www.till-hilft.de

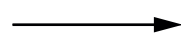

Montagehilfen



SK

Dôležité bezpečnostné upozornenia

Inštaláciu lampy smú vykonať výhradne autorizovaní



www.till-hilft.de

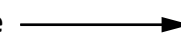

Montagehilfen



FR

signes de sécurité importantes

La L'installation votre nouveau luminaire doit uniquement être réalisée par des spécialistes autorisés



www.till-hilft.de

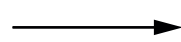

Montagehilfen



HU

Fontos biztonsági utmutatások

Az On Új lámpájának beszerelését kizárólag hivatalos szakember végezheti el



www.till-hilft.de

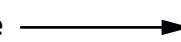

Montagehilfen



IT

Important disposizioni di sicurezza

L'installazione della il loro nuovo lampada può essere eseguita solo ed esclusivamente da personale tecnico autorizzato.



www.till-hilft.de

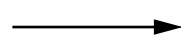

Montagehilfen



RO

Instrucțiuni de siguranță importante

Instalarea noii dumneavoastră lămpi este permisă exclusiv specialișilor autorizați



www.till-hilft.de

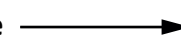

Montagehilfen



NL

Belangrijke veiligheidsaanwijzingen

De installatie van de nieuwe lamp moet worden uitgevoerd door vakbekwame personen worden uitgevoerd.



www.till-hilft.de

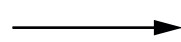

Montagehilfen



TR

Önemli güvenlik uyarıları

Yeni lamba montajı yetkin kişiler tarafından yapılmalıdır



www.till-hilft.de

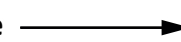

Montagehilfen



CZ

Důležité bezpečnostní pokyny

Instalaci nových svídel smí provádět pouze kvalifikovaný elektrikář



www.till-hilft.de



Montagehilfen



RU

важная информация по технике безопасности

Установка вашей новой лампы должна выполняться квалифицированным персоналом



www.till-hilft.de



Montagehilfen



89904.330



D

Wichtige Sicherheitshinweise

Die Installation Ihrer neuen Leuchte darf ausschließlich von autorisierten Fachpersonen durchgeführt werden.



www.till-hilft.de

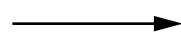

Montagehilfen



PL

Ważne wskazówki dotyczące bezpieczeństwa

Ta instalację nowej lampy mogą przeprowadzać wyłącznie autoryzowani instalatorzy



www.till-hilft.de

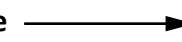

Montagehilfen



GB

Important safety instructions

The installation of your new luminaire may only be carried out by authorized specialists.



www.till-hilft.de

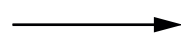

Montagehilfen



SK

Dôležité bezpečnostné upozornenia

Inštaláciu lampy smú vykonať výhradne autorizovaní



www.till-hilft.de

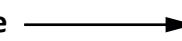

Montagehilfen



FR

signes de sécurité importantes

La L'installation votre nouveau luminaire doit uniquement être réalisée par des spécialistes autorisés



www.till-hilft.de

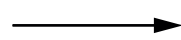

Montagehilfen



HU

Fontos biztonsági utmutatások

Az On Új lámpájának beszerelését kizárólag hivatalos szakember végezheti el



www.till-hilft.de

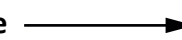

Montagehilfen



IT

Important disposizioni di sicurezza

L'installazione della il loro nuovo lampada può essere eseguita solo ed esclusivamente da personale tecnico autorizzato.



www.till-hilft.de

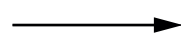

Montagehilfen



RO

Instrucțiuni de siguranță importante

Instalarea noii dumneavoastră lămpi este permisă exclusiv specialișilor autorizați



www.till-hilft.de

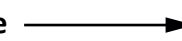

Montagehilfen



NL

Belangrijke veiligheidsaanwijzingen

De installatie van de nieuwe lamp moet worden uitgevoerd door vakbekwame personen worden uitgevoerd.



www.till-hilft.de

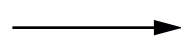

Montagehilfen



TR

Önemli güvenlik uyarıları

Yeni lamba montajı yetkin kişiler tarafından yapılmalıdır



www.till-hilft.de

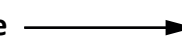

Montagehilfen



CZ

Důležité bezpečnostní pokyny

Instalaci nových svídel smí provádět pouze kvalifikovaný elektrikář



www.till-hilft.de

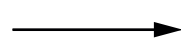

Montagehilfen



RU

важная информация по технике безопасности

Установка вашей новой лампы должна выполняться квалифицированным персоналом



www.till-hilft.de

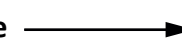

Montagehilfen



89904.330