



44 Avenue Paul Girard
10500 DIENVILLE
FRANCE
www.sciae.com

MALT

INDICE B - 26/01/2022
MALT 0123 BIBLIOTHEQUE 1PO N°01 Réf: 21SC3410

MALT 0123 EAN: 3102000112237

NOTICE DE MONTAGE
ASSEMBLING INSTRUCTIONS
MONTAGEANLEIUNG
MANUAL DE MONTAJE
MONTAGEVOORSCHRIFT
INSTRUÇÕES DE MONTAGEM
ISTRUZIONI DI MONTAGGIO
ИНСТРУКЦИЯ ПО СБОРКЕ
Naputci za montažu

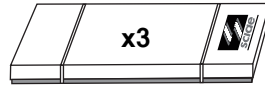
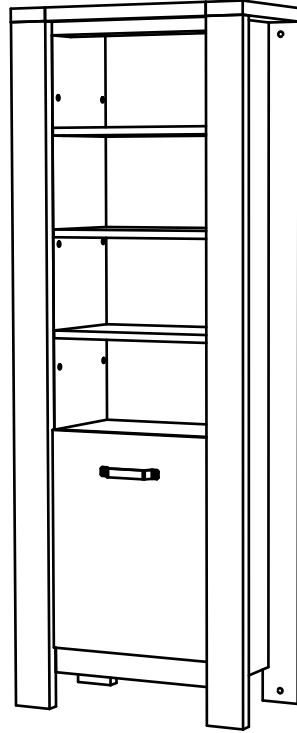

Package 1: 20 Kg
Package 2: 21.5 Kg
Package 3: 25 Kg

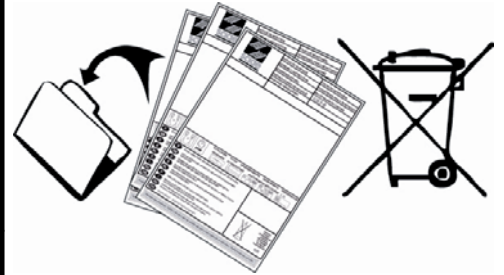

- F** POUR L'APRES-VENTE, RETOURNEZ AU MAGASIN AVEC CETTE NOTICE
- GB** FOR THE AFTER SALES, GO BACK TO THE SHOP WITH THIS ASSEMBLY INSTRUCTION
- D** WENDEN SIE SICH BITTE AN IHREN HANDLER UND GEBEN SIE IHM DIE KENNUMMER DES MOBELS UND DIE TEILNUMMER
- E** EN CASO DE SERVICIO POST-VENTA DEBEN DE VOLVER A LA TIENDA CON LAS INSTRUCCIONES DE MONTAJE
- NL** VOOR SERVICE NA VERKOOP, GA NAAR UW LEVERANCIER MET DEZE MONTAGE HANDLEIDING
- P** PARA O POS VENDA, VOLTE A LOJA COM ESTA FOLHA
- I** SERVIZIO POST VENDITA: E NECESSARIO PRESENTARSI SUL PUNTO VENDITA CON QUESTE ISTRUZIONI DI MONTAGGIO
- RU** ДЛЯ ПОСЛЕПРОДАЖНОГО ОБСЛУЖИВАНИЯ ПРОСЬБА ОБРАТИТЬСЯ В МАГАЗИН ПРЕДЪЯВИВ НАСТОЯЩУЮ ИНСТРУКЦИЮ ПО СБОРКЕ
- HR** U SLUČAJU REKLAMACIJE, VRATITE SE NA PRODAJNO MJESTO S OVIM UPUTAMA ZA MONTAŽU

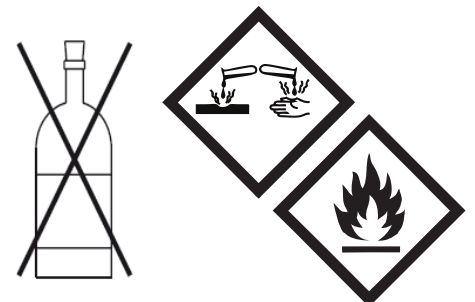
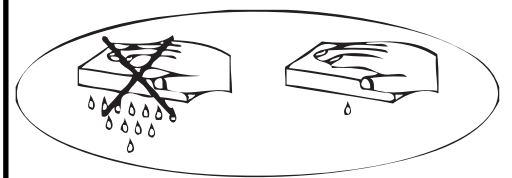

	+40°C +104°F	
	HYGROMETRIE HYGROMETRY 40%-65%	
	+15°C +59°F	

1 an
1 year

OK

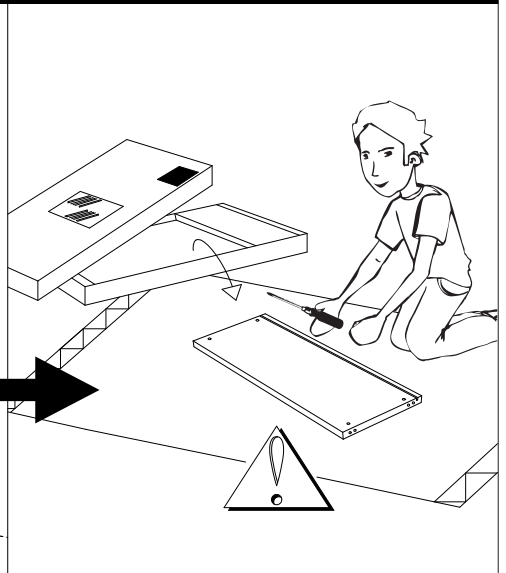
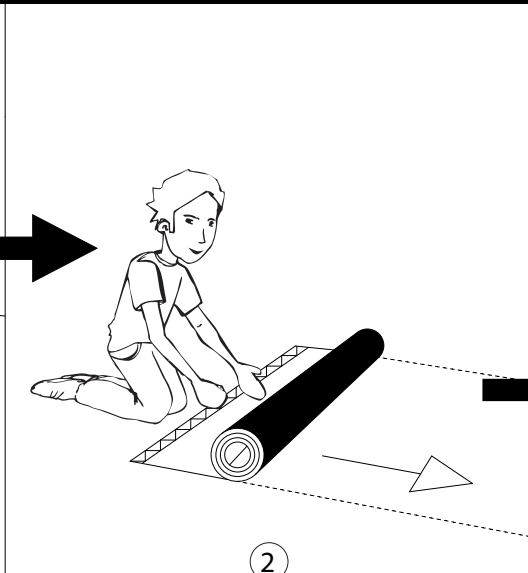
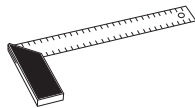
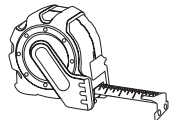
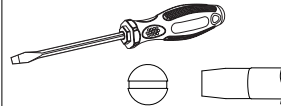
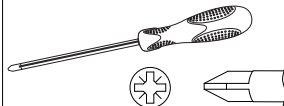
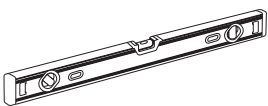
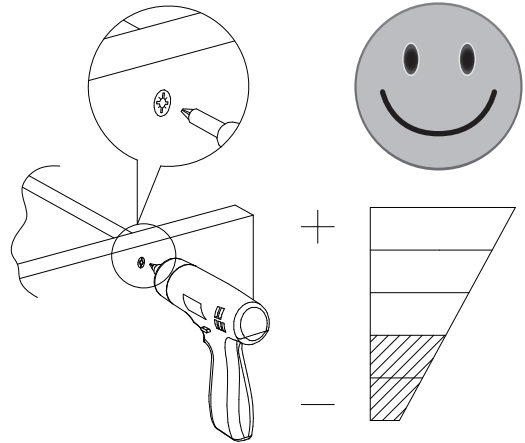
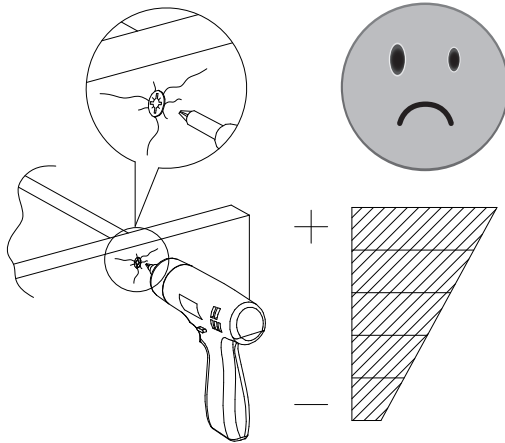
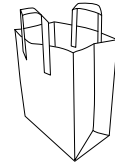
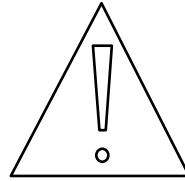

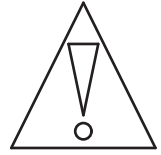
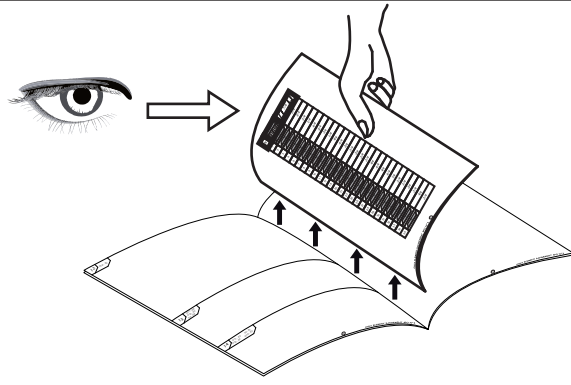

1

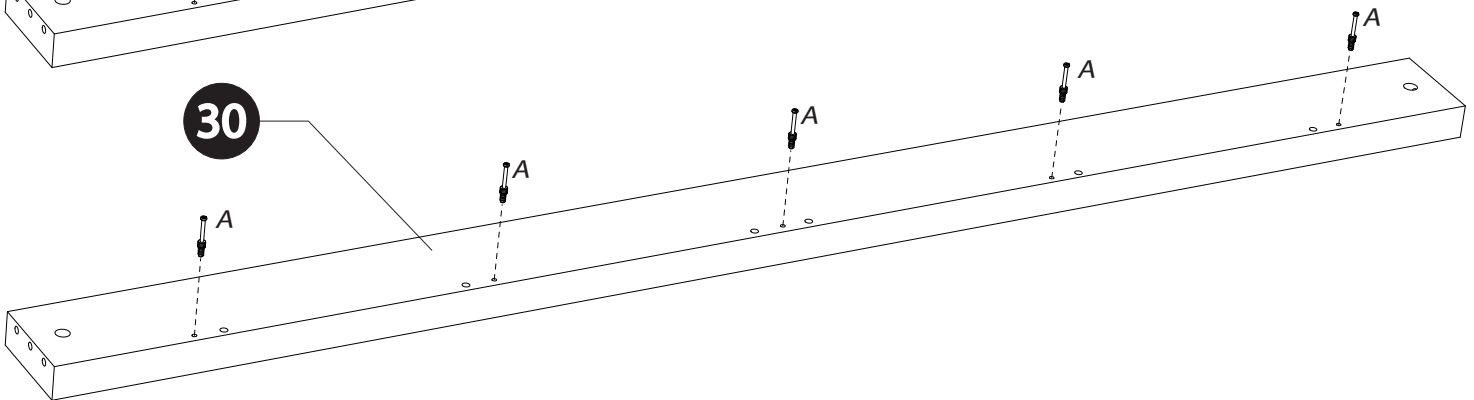
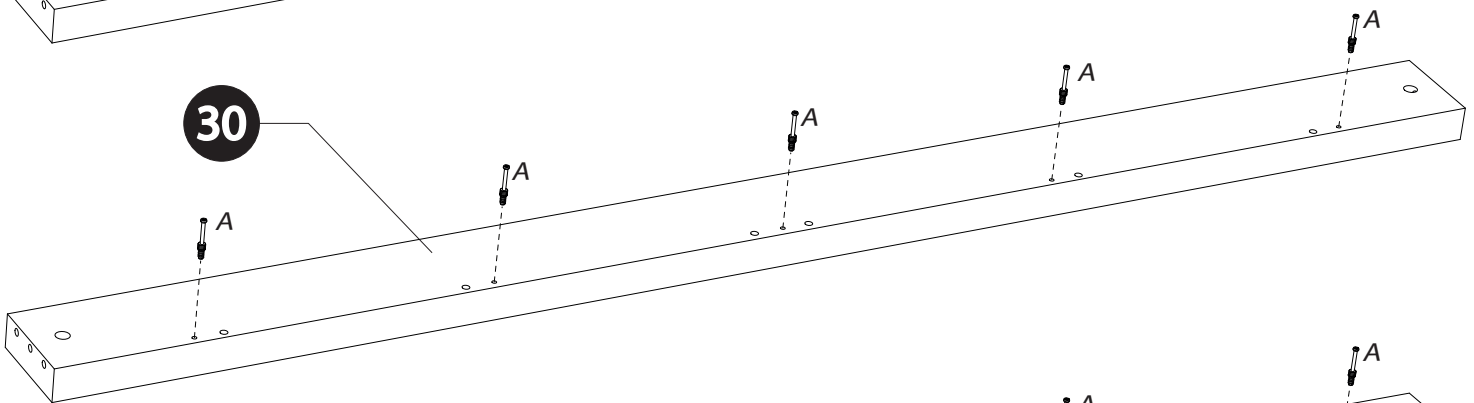
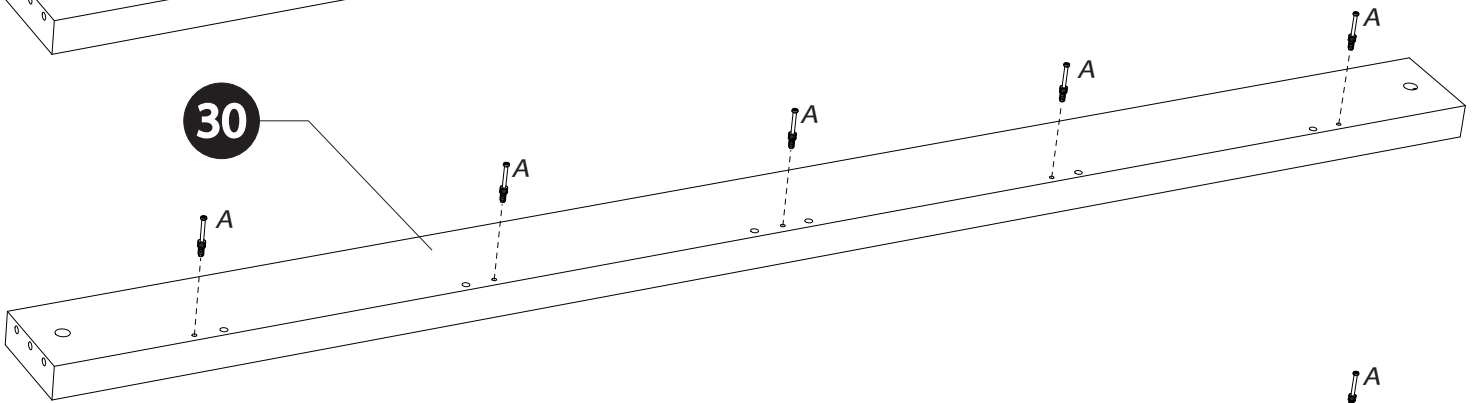
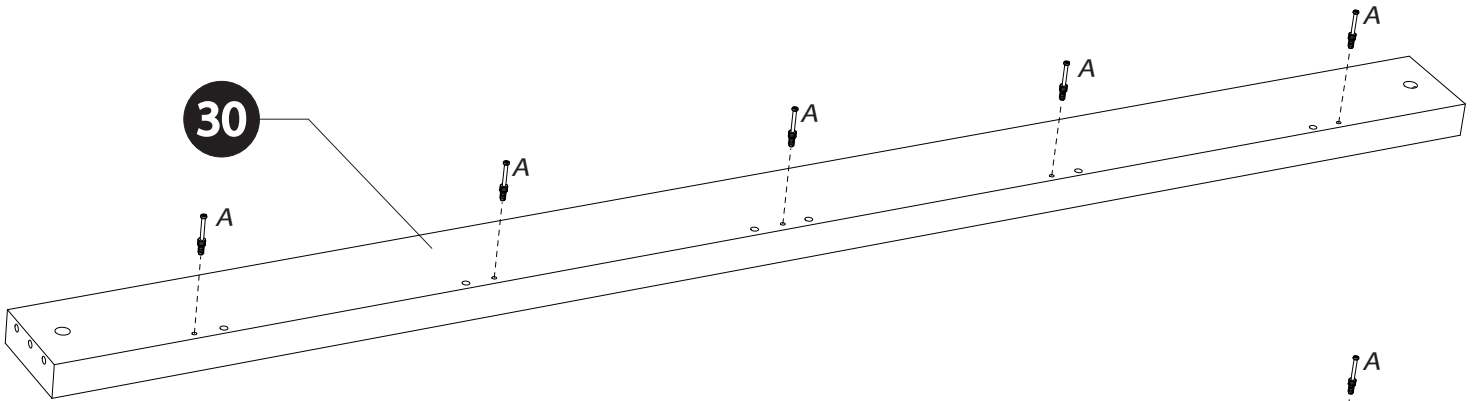
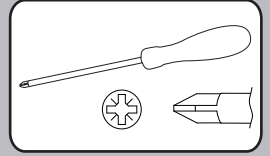
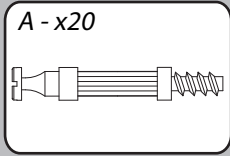

2

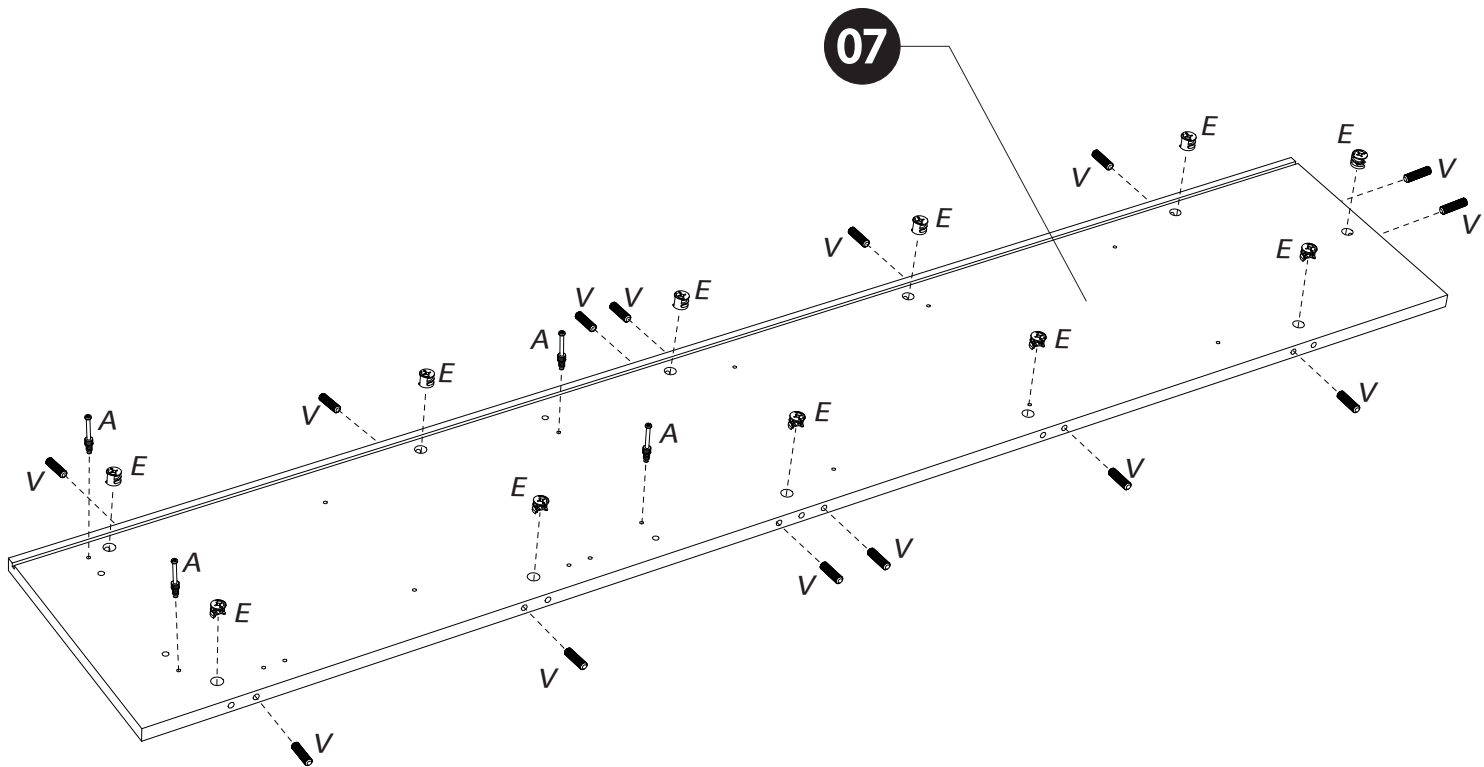
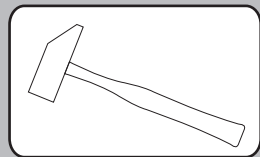
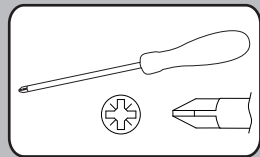
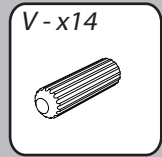
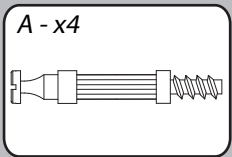
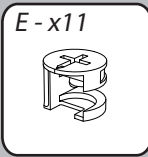

3

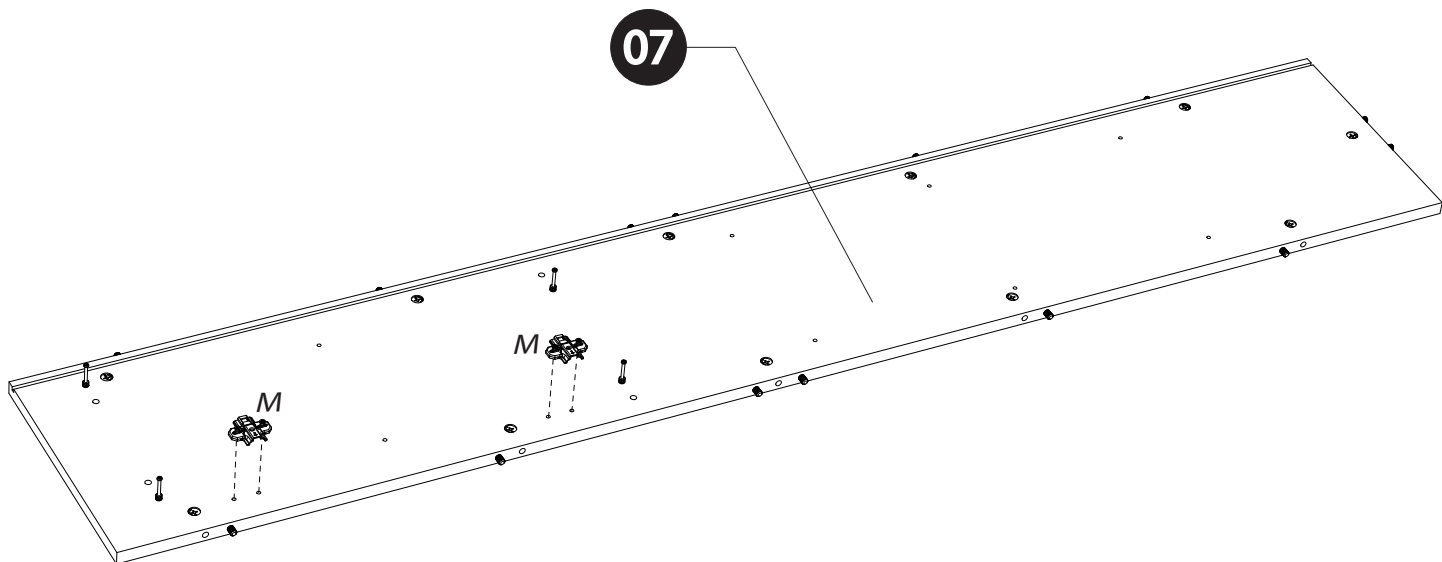
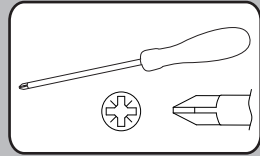
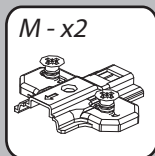

4

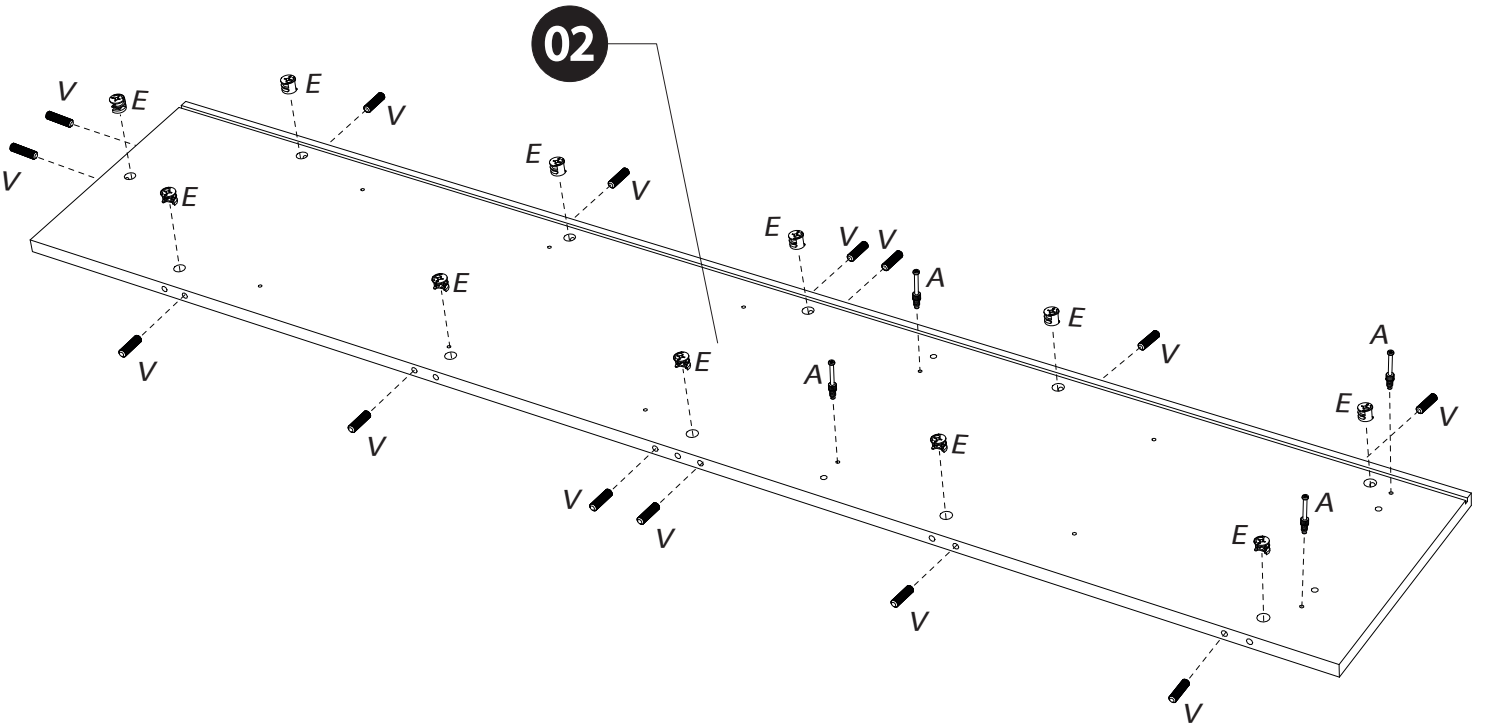
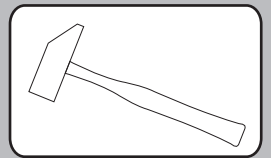
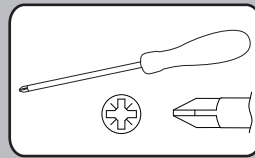
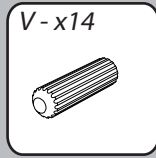
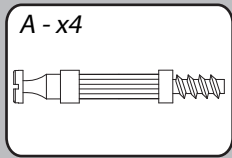
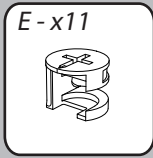

5

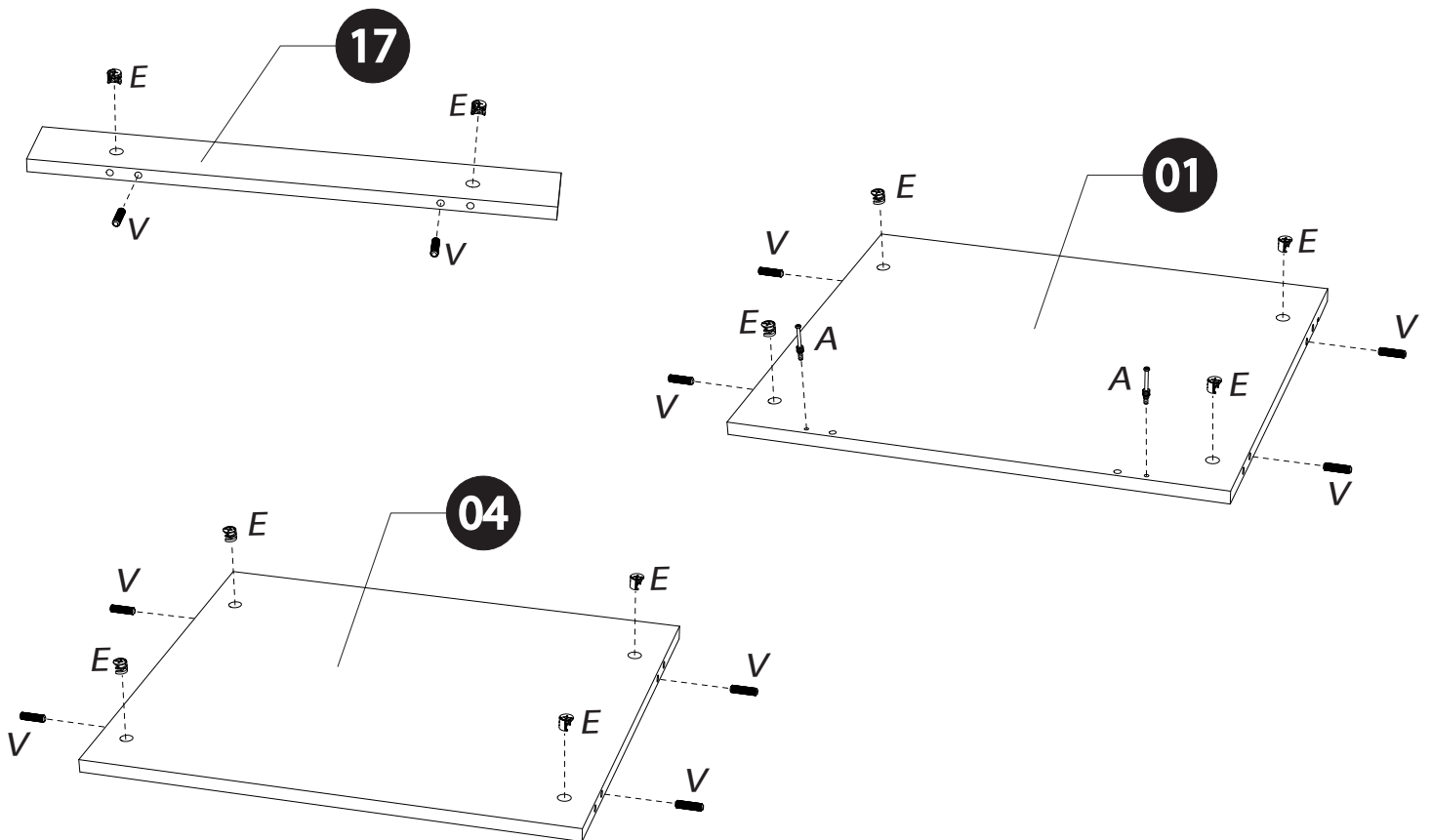
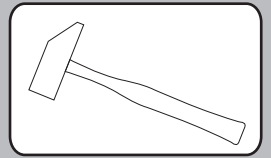
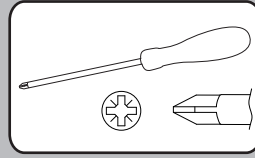
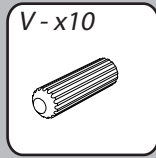
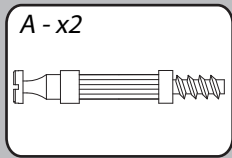
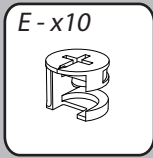

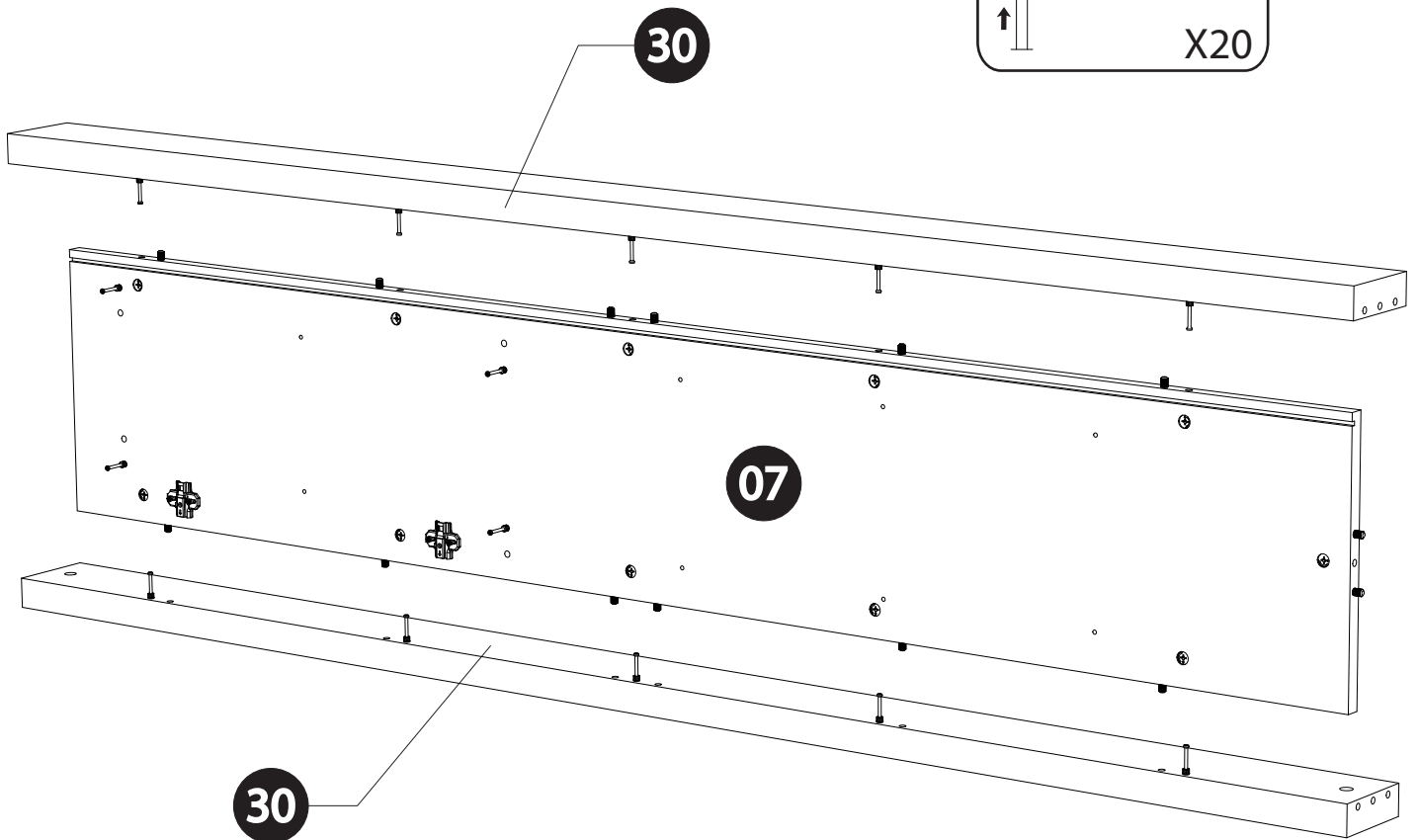
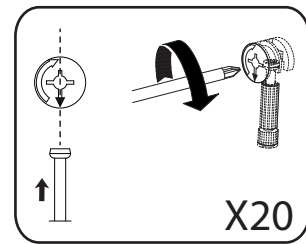
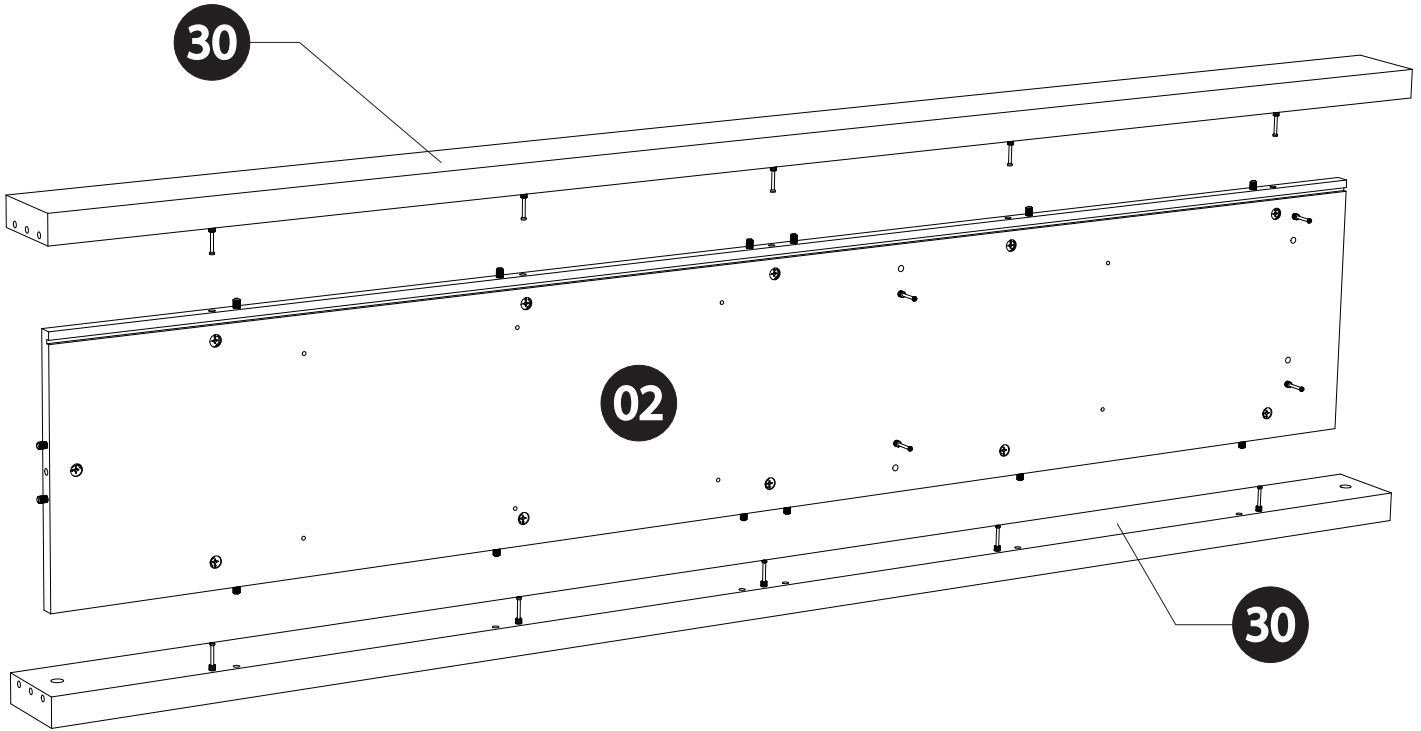
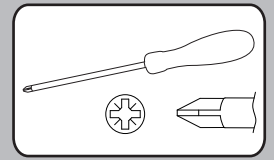

7

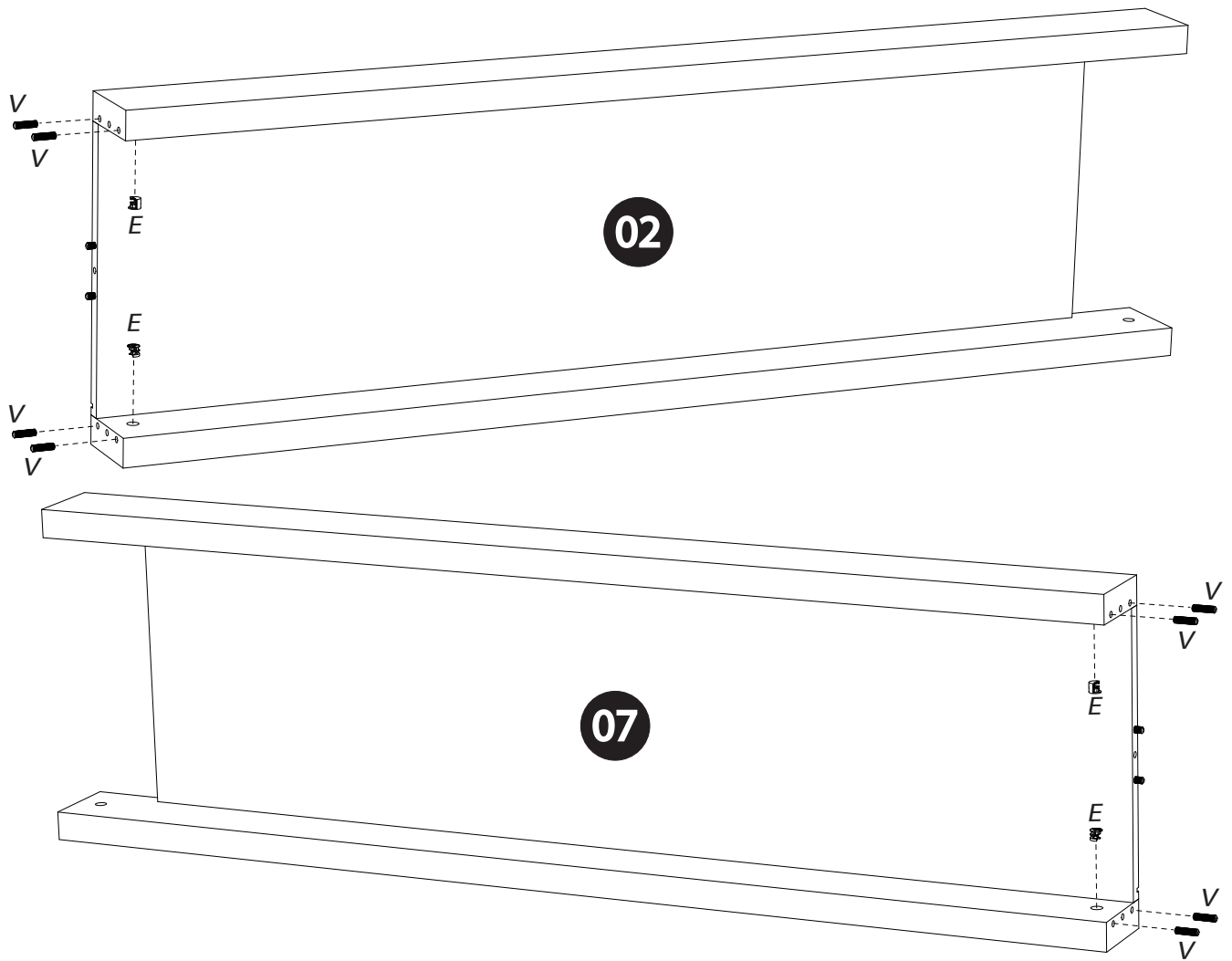
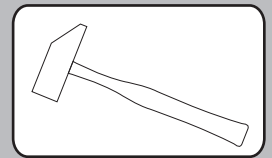
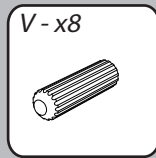
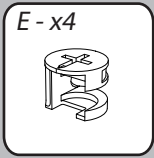

8

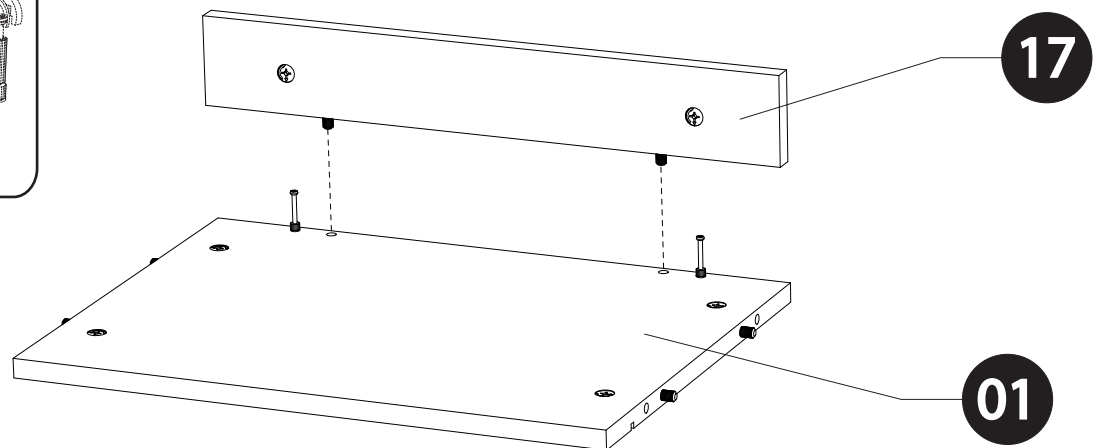
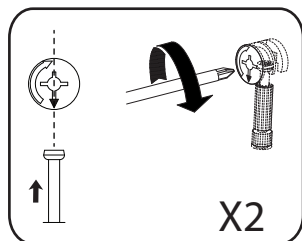
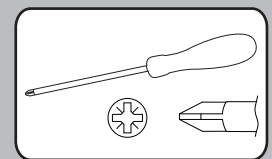



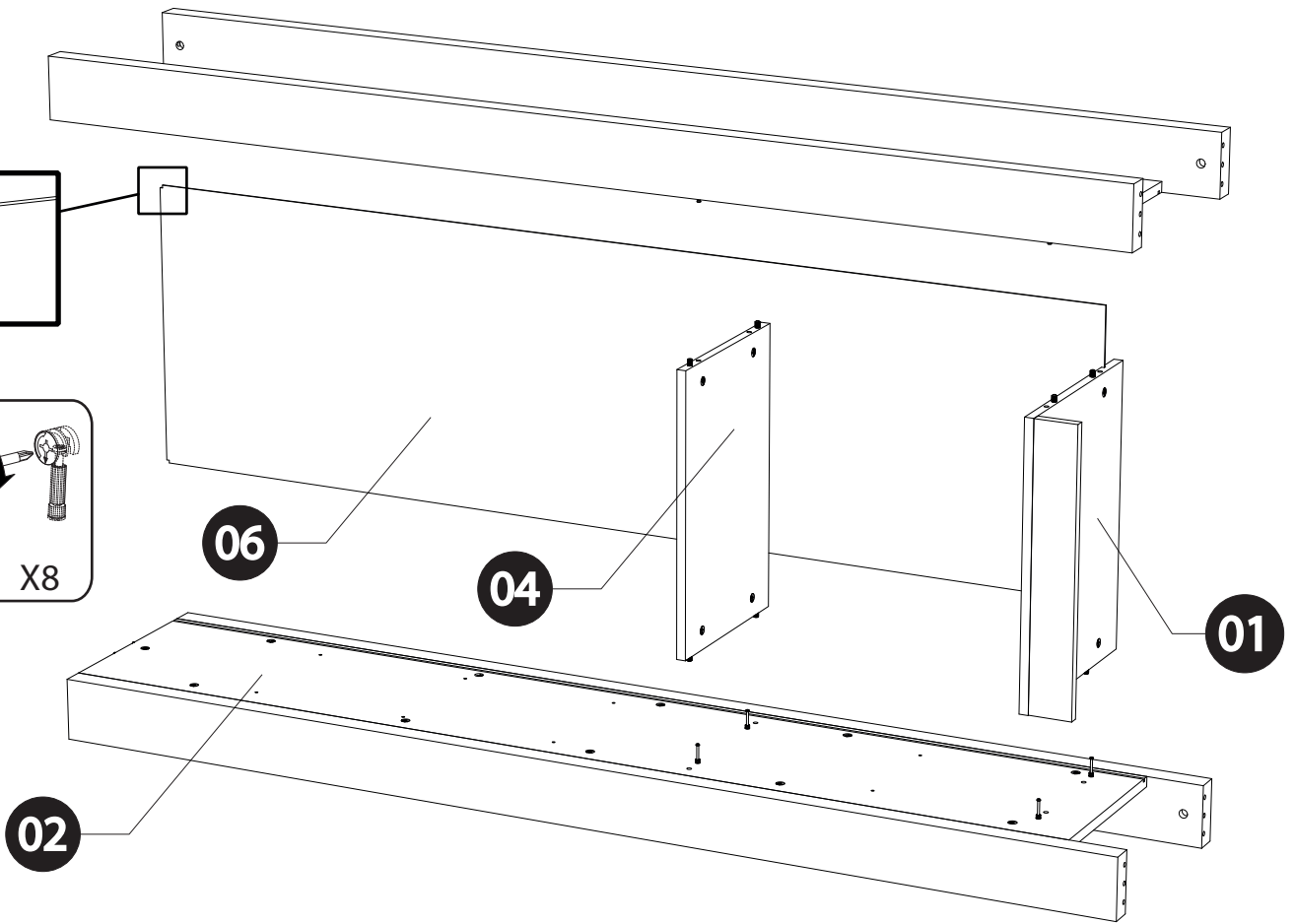
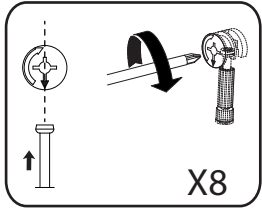
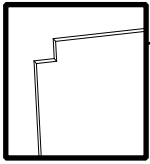
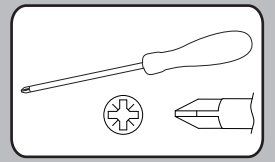



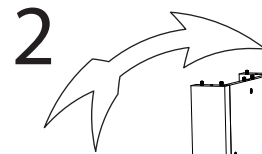
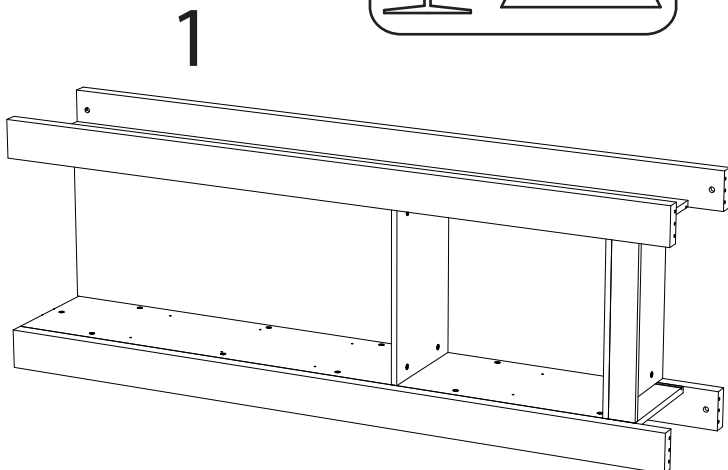
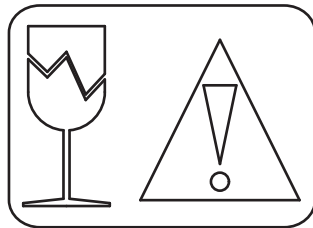
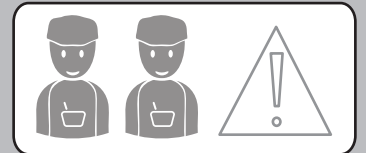

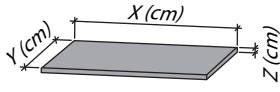
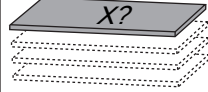
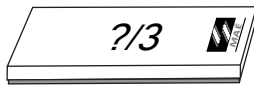

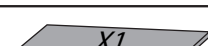

9

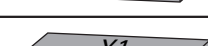

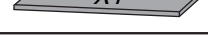
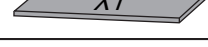
10



<i>DESIGNATION</i>		<i>N°</i>		
Dessous	49.7 x 37.2 x 1.6	1		1
Côté gauche	186.2 x 33.4 x 1.8	2		2
Intermédiaire	49.7 x 31.9 x 1.6	4		1
Derrière	178 x 50.7x 0.25	6		2
Côté droit	186.2 x 33.4 x 1.8	7		2
Dessus	49.7 x 41.2 x 3.8	8		1
Tablette haute	49.6 x 31.8 x 2.2	9		1
Porte droite	62.9 x 49.1 x 1.6	11		2
Face de socle	49.6 x 7.5 x 1.6	17		1
Bandeau de dessus	49.6 x 11 x 3.8	18		3
Tablette basse	49.6 x 29 x 1.6	19		1
Alaise de dessus	41.2 x 11 x 3.8	21		3
Montant	196.2 x 11 x 3.8	30		3

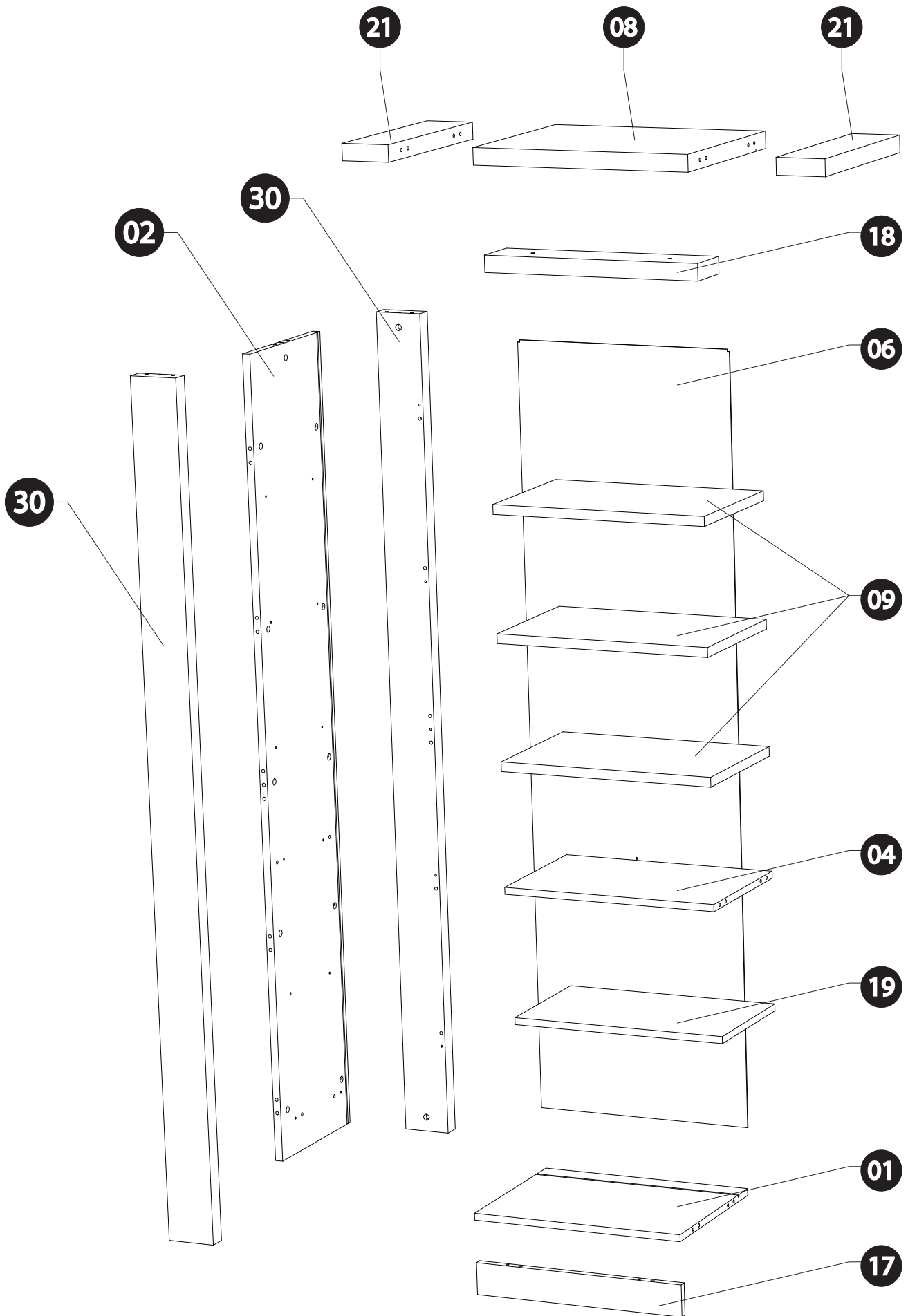

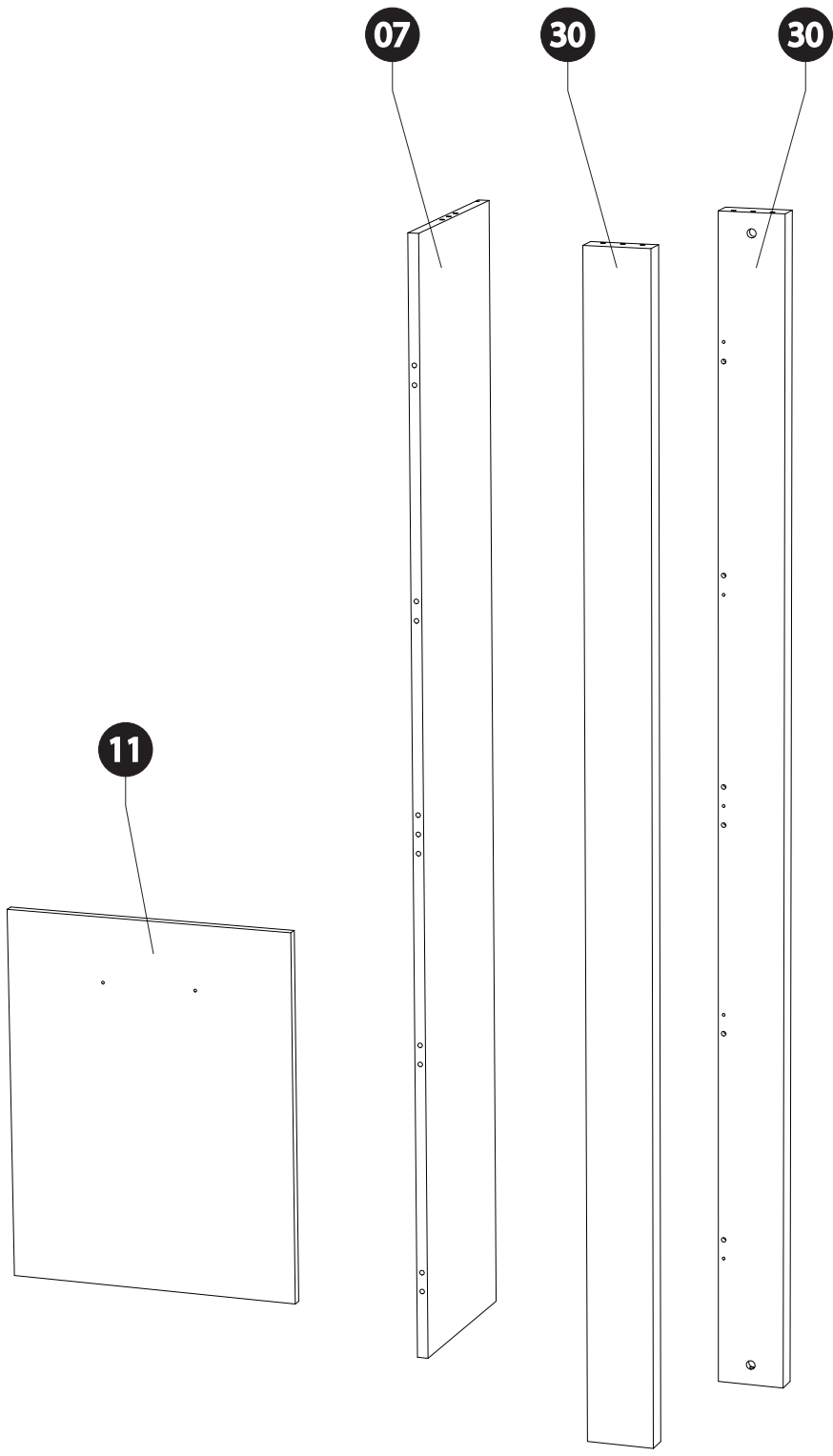

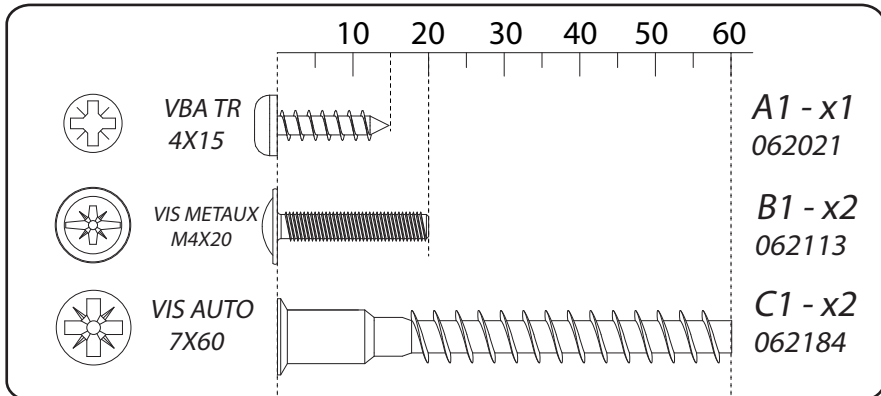
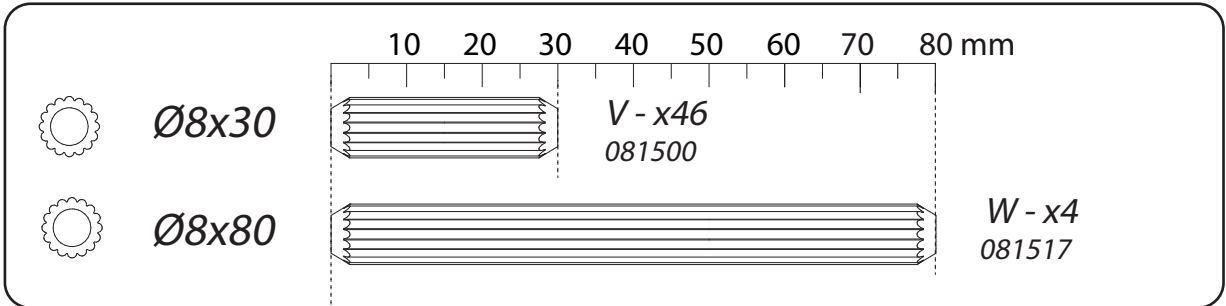
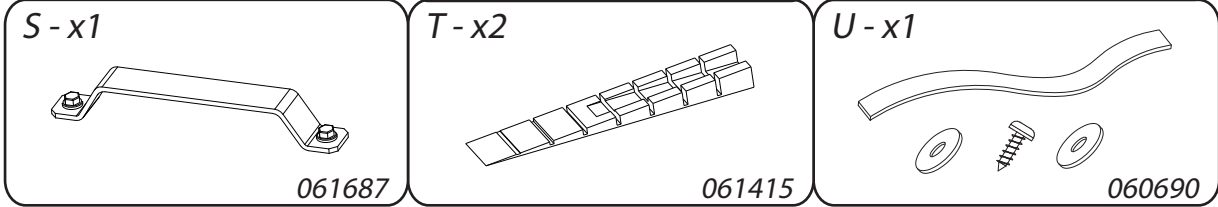
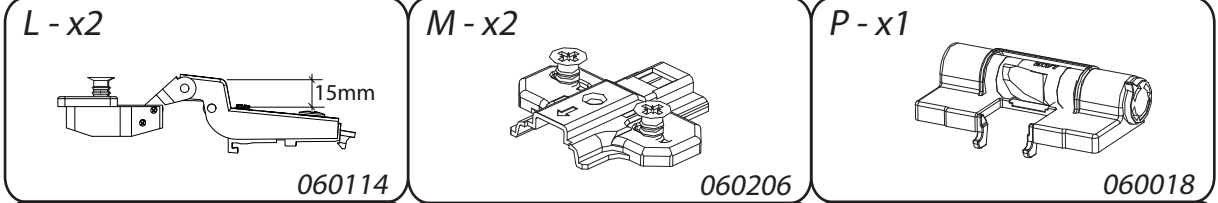
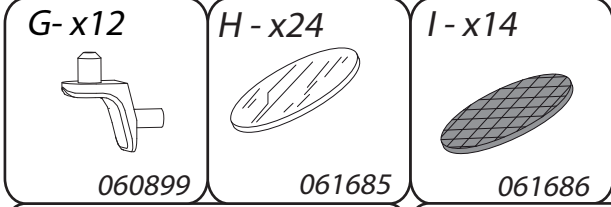
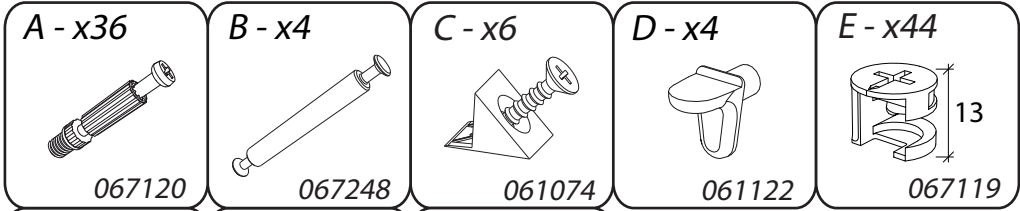

11

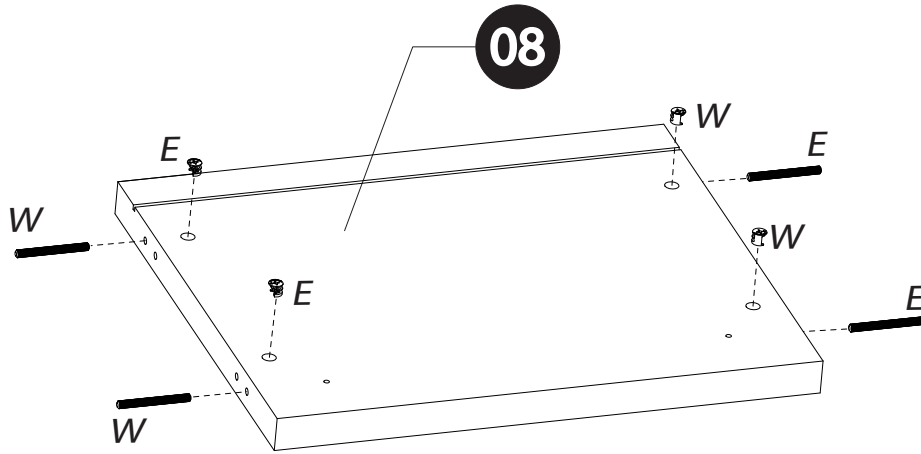
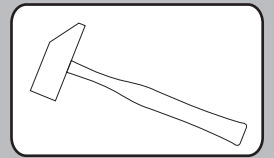
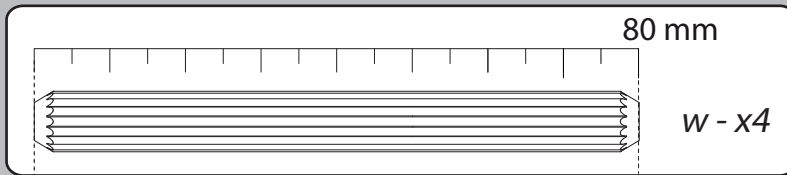
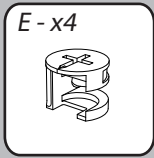

12

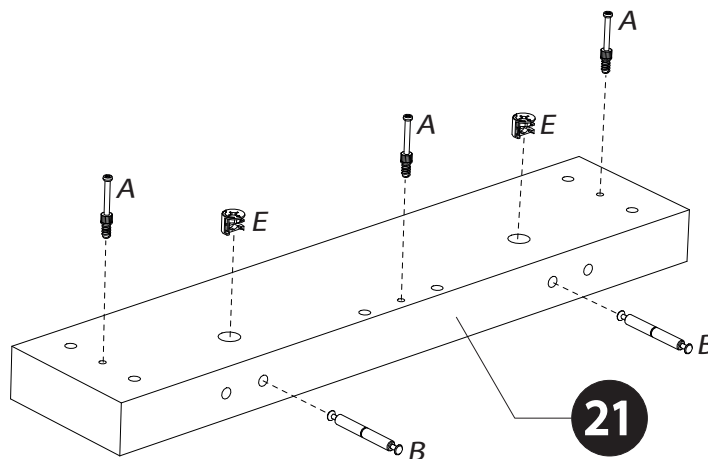
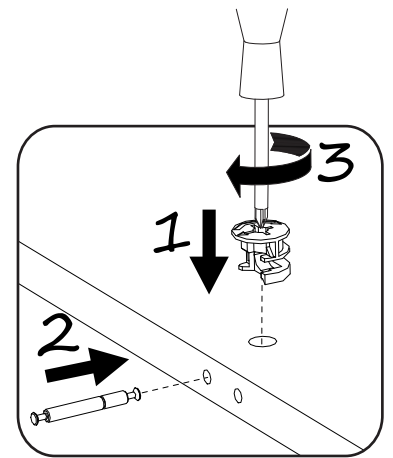
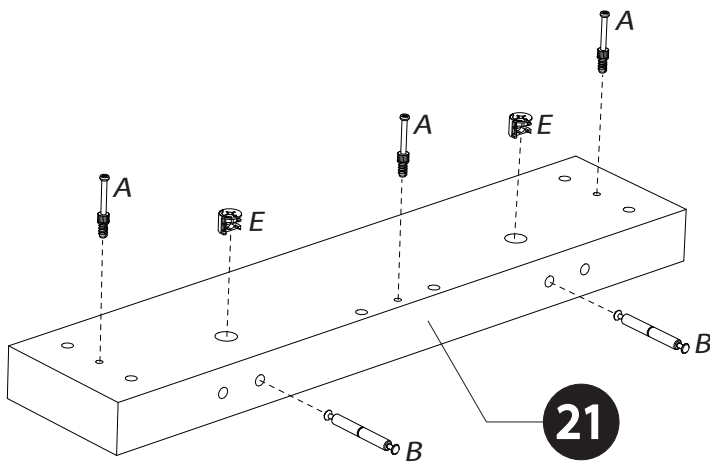
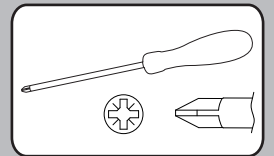
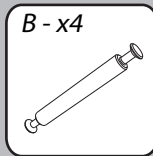
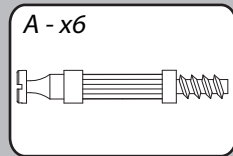
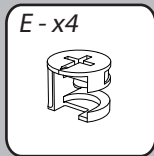

13

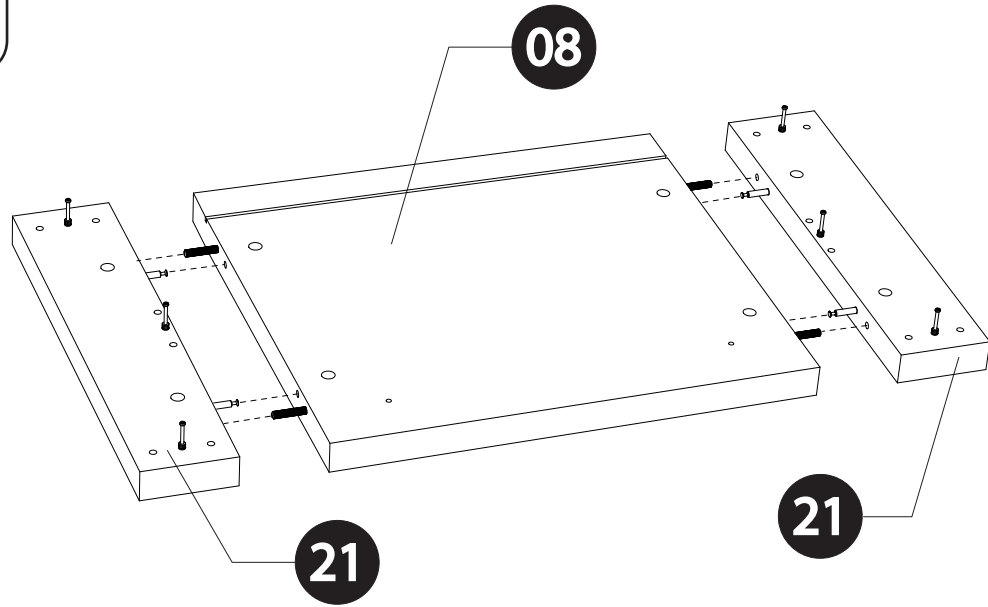
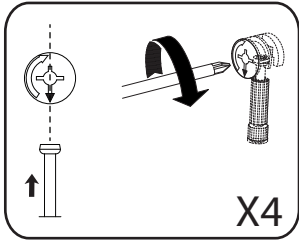
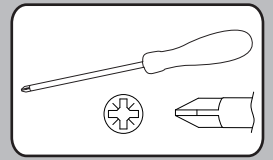

14

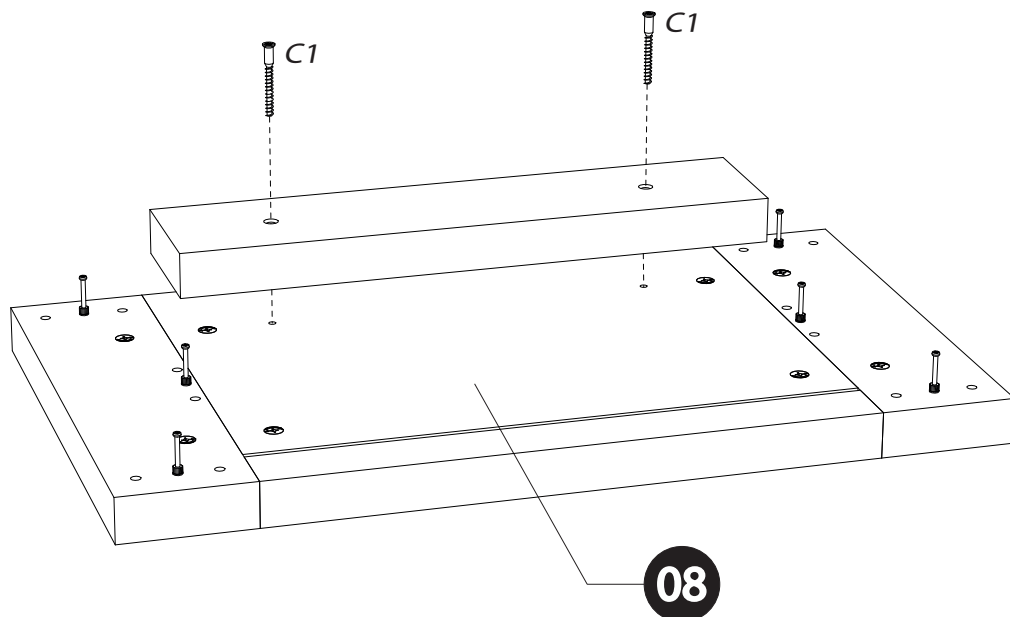
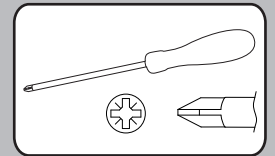
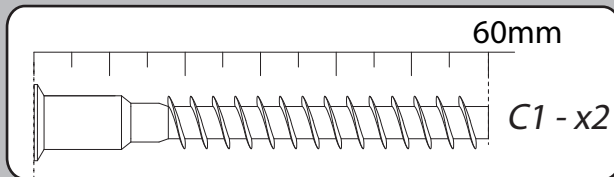

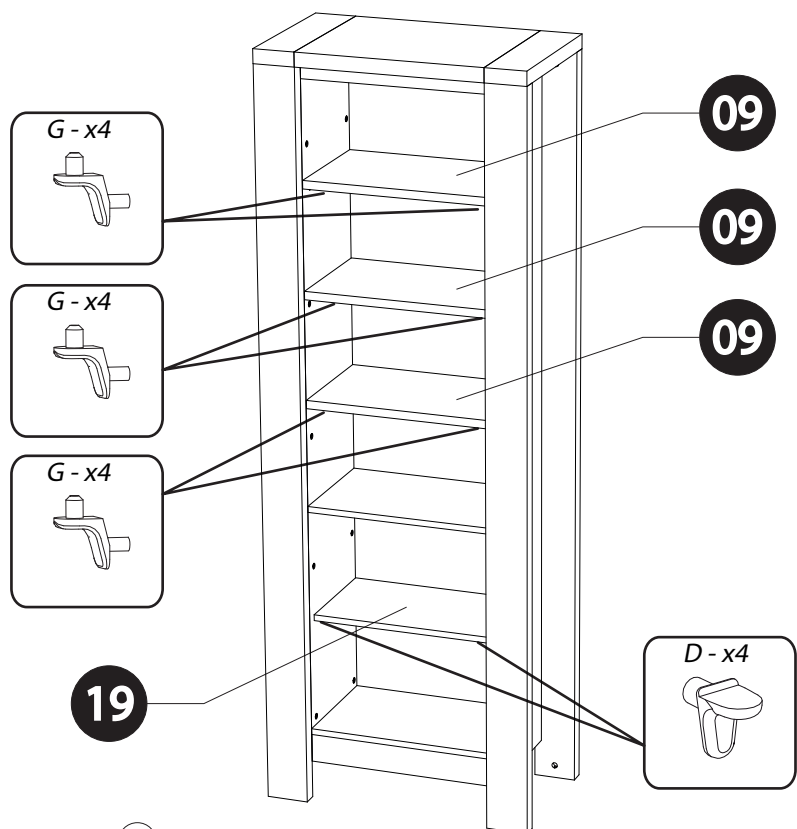
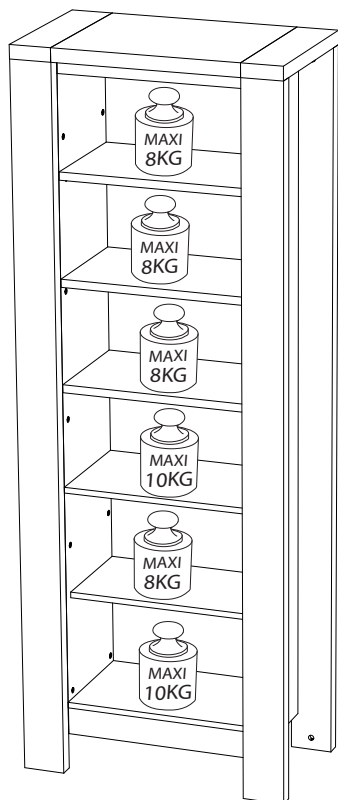
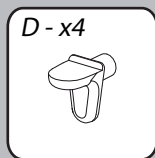
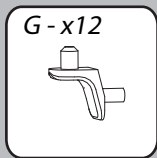
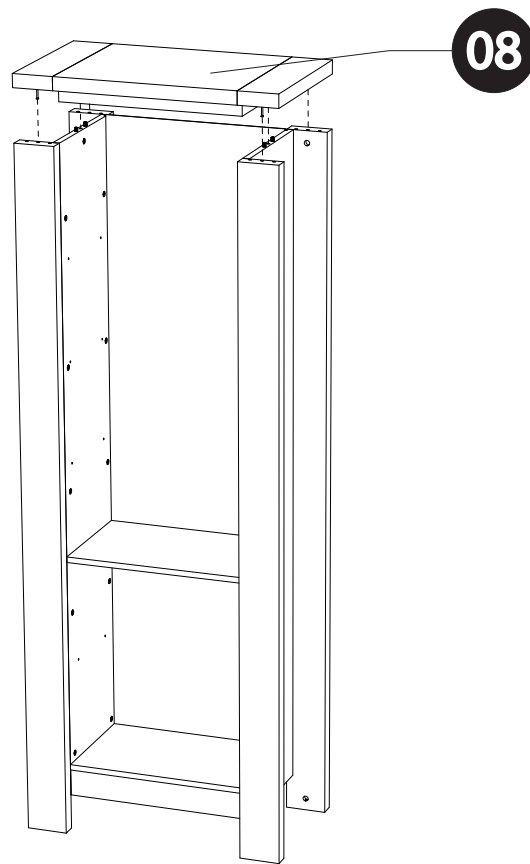
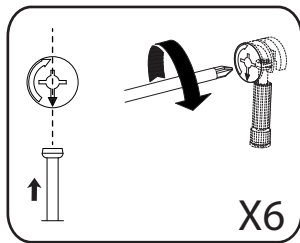
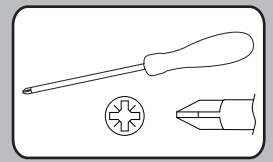

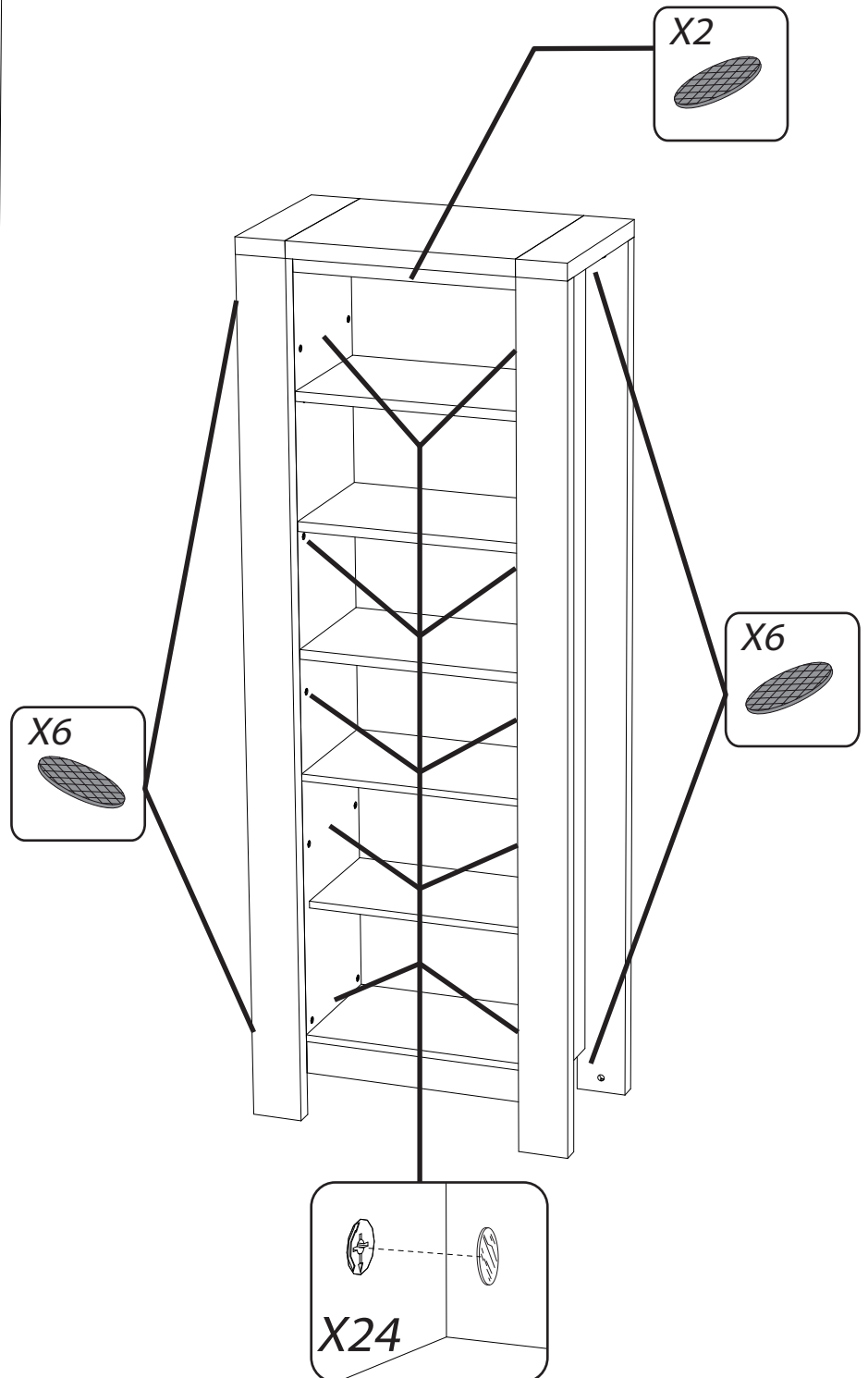
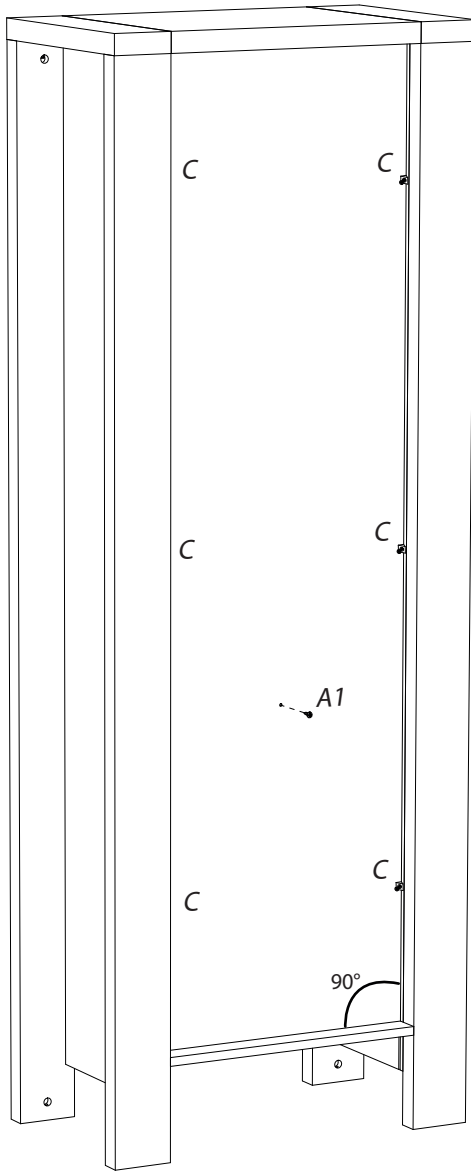
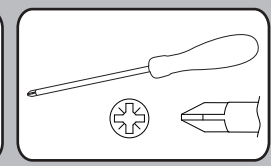
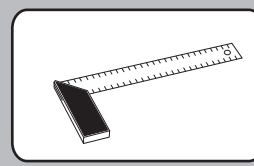
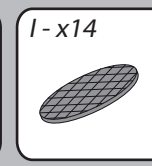
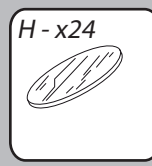
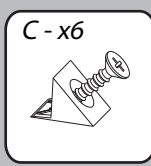
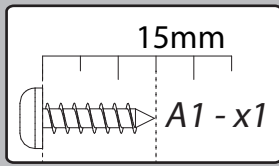

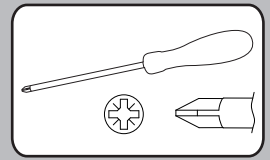
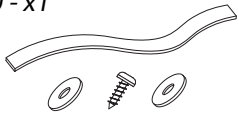

FRANCAIS: Pour votre sécurité il est impératif de fixer votre meuble au mur.

Pour cela tous les meubles hauts disposent d'un dispositif d'accrochage, disponible à l'intérieure de votre colis.

Si tel n'est pas le cas, veuillez en faire la demande auprès de votre revendeur.

Cela empêche toute chute accidentelle du meuble.

ENGLISH: For your safety it is compulsory to fix your furniture to the wall.

For this reason, all the high cabinets have a hanging system, available inside your package.

If this is not the case, please contact your reseller.

This prevents any accidental falling of the furniture.

DEUTSCH: Zu Ihre Sicherheit muss Ihre Möbel an der Wand befestigt.

Aus diesem Grund verfügen alle Hochschränke über eine Aufhängevorrichtung, die in der verpackung steht.

Falls nicht, bitte verwenden sie sich an ihren Händler.

Es vermeidet jede zufällig fallen.

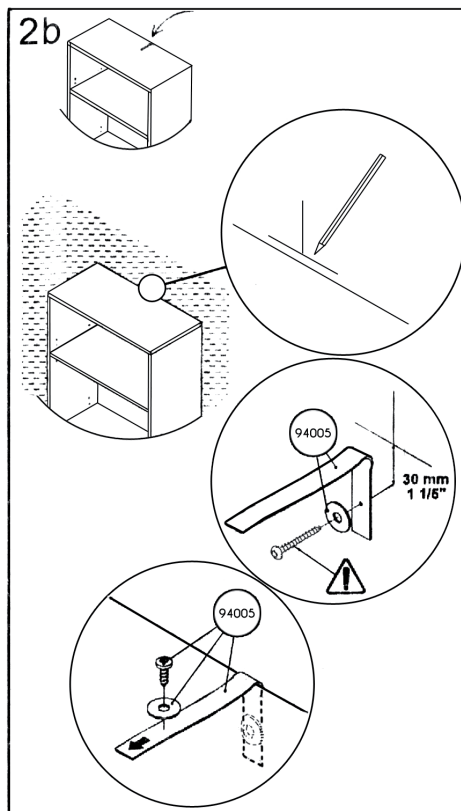
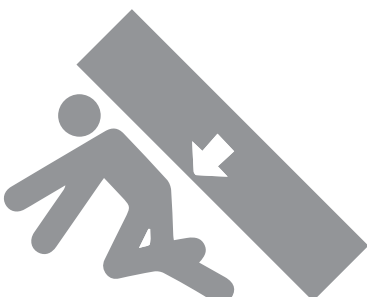
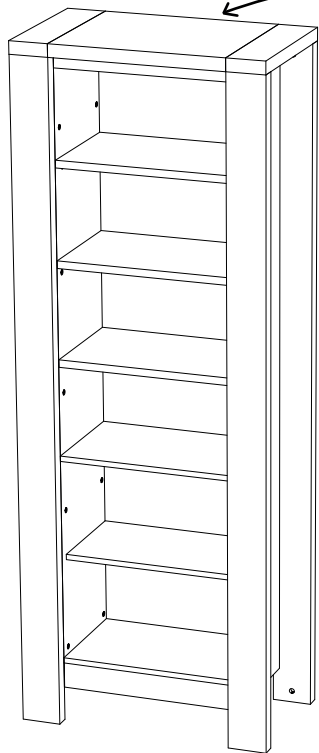

FRANCAIS

IMPORTANT: La vis fournie avec le dispositif anti-bascule est destinée à fixer le dispositif dans le meuble. Pour la fixation au mur, compléter par une vis adaptée au support mural. En cas de doute, contacter un magasin de bricolage.

ENGLISH

IMPORTANT: The screw supplied together with the anti-topple bracket is to be used only for fixing the anti-topple bracket to the furniture. In addition to this, you will need to choose a screw or fitting which is suitable for securing the bracket to the kind of walls you have. If you are unsure about what type of screw to use contact your local hardware store.

DEUTSCH

WICHTIG: Die dem kippschutz beigefügten schrauben sind ausschließlich für die befestigung des kippschutzes am möbelstück vorgesehen. Für die befestigung des kippschutzes an der wand benötigen sie zusätzlich schrauben oder beschläge, die zur beschaffenheit der wand passen. Falls sie nicht sicher sind, welche art von schrauben geeignet sind, wenden sie sich bitte an den fachhandel.

0194007-50

19

T-x2

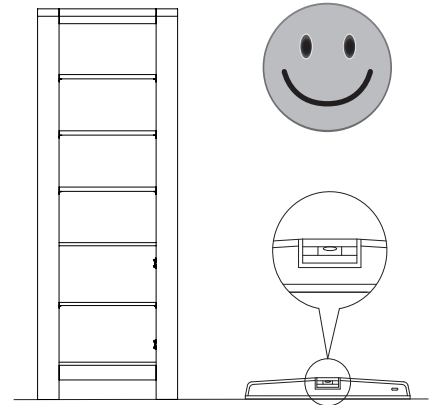
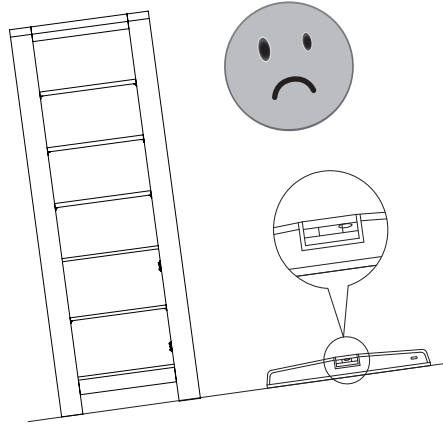
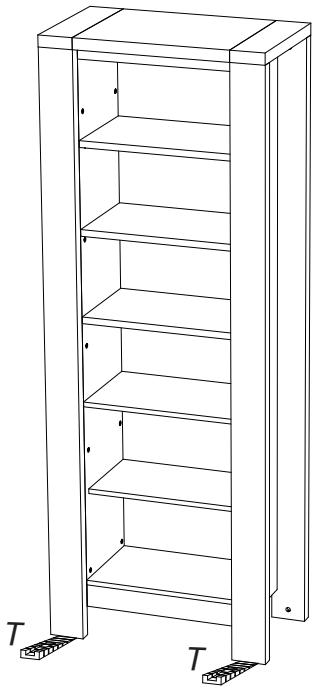
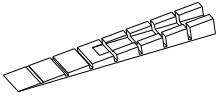

20

L-x2

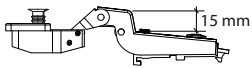

P-x1

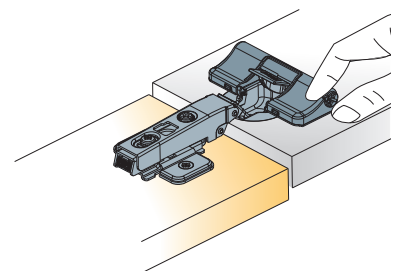
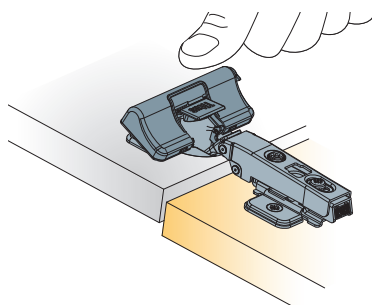
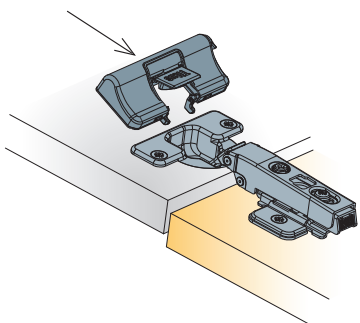
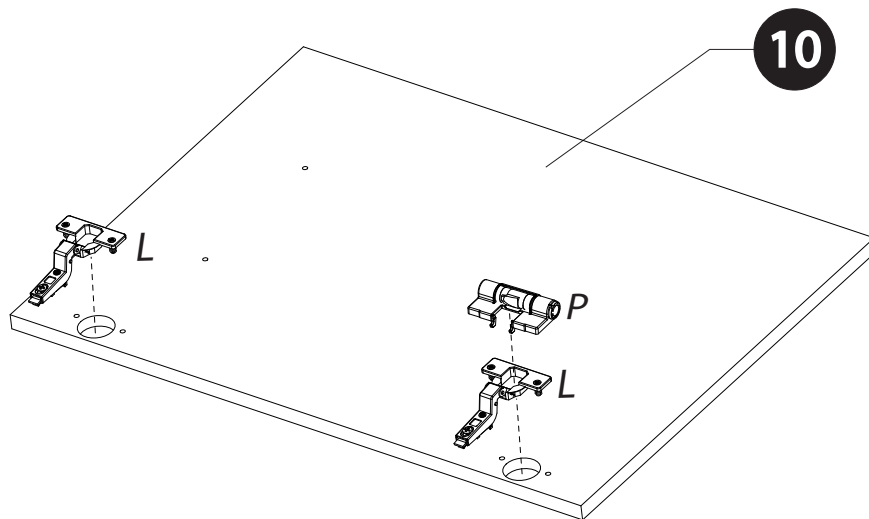
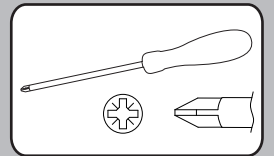
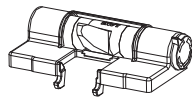

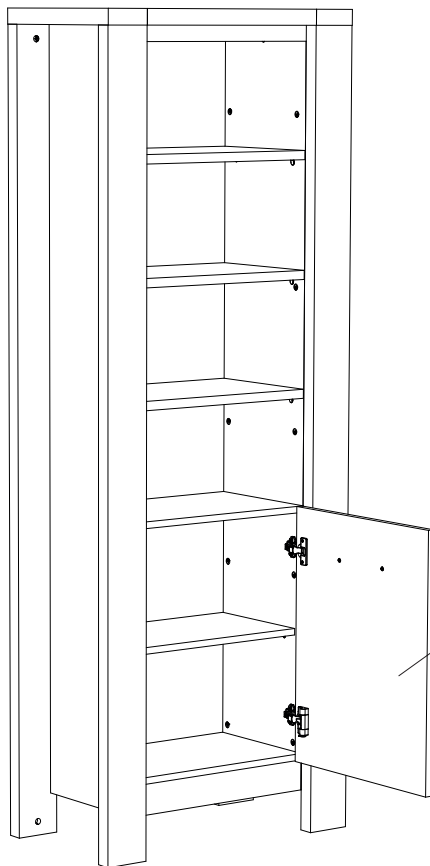
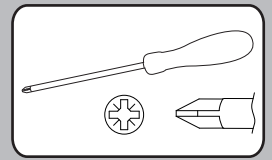

10

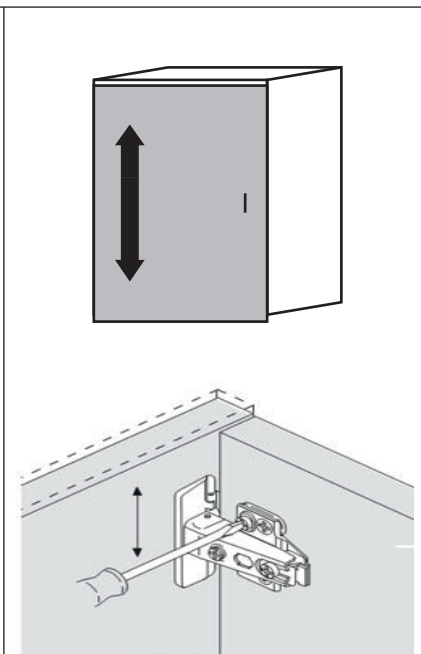
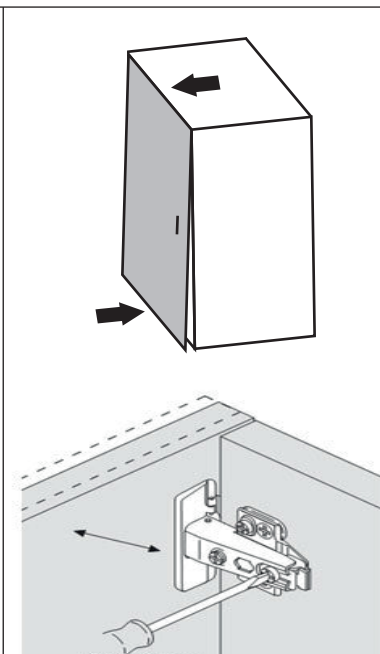
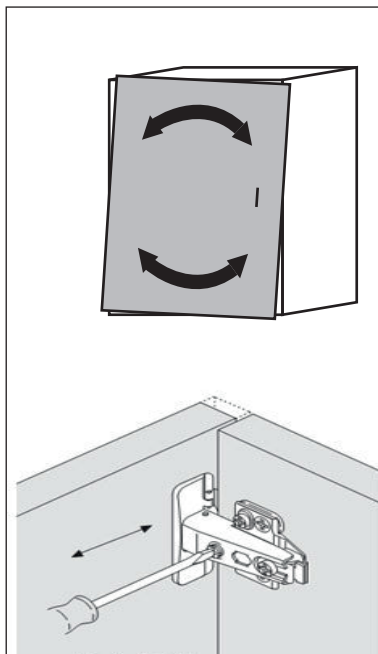
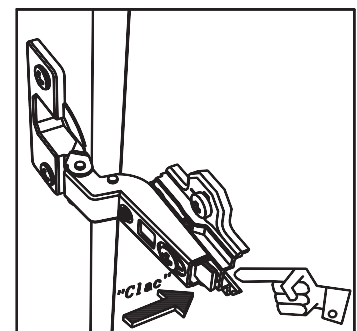
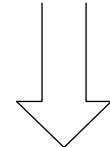
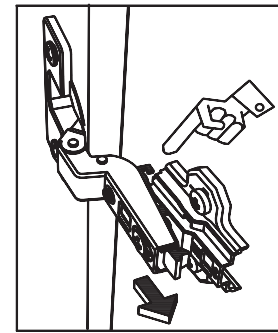

FRANCAIS Recommandations de démontage :

En cas de déménagement, il convient de procéder au démontage de votre meuble, en ôtant toute la visserie.

ENGLISH Disassembly advices:

In case of moving, it is needed to dismantle the furniture removing the fittings.

DEUTSCH Empfehlungen für die Demontage:

Bei Transport bitte alle Beschläge demontieren.

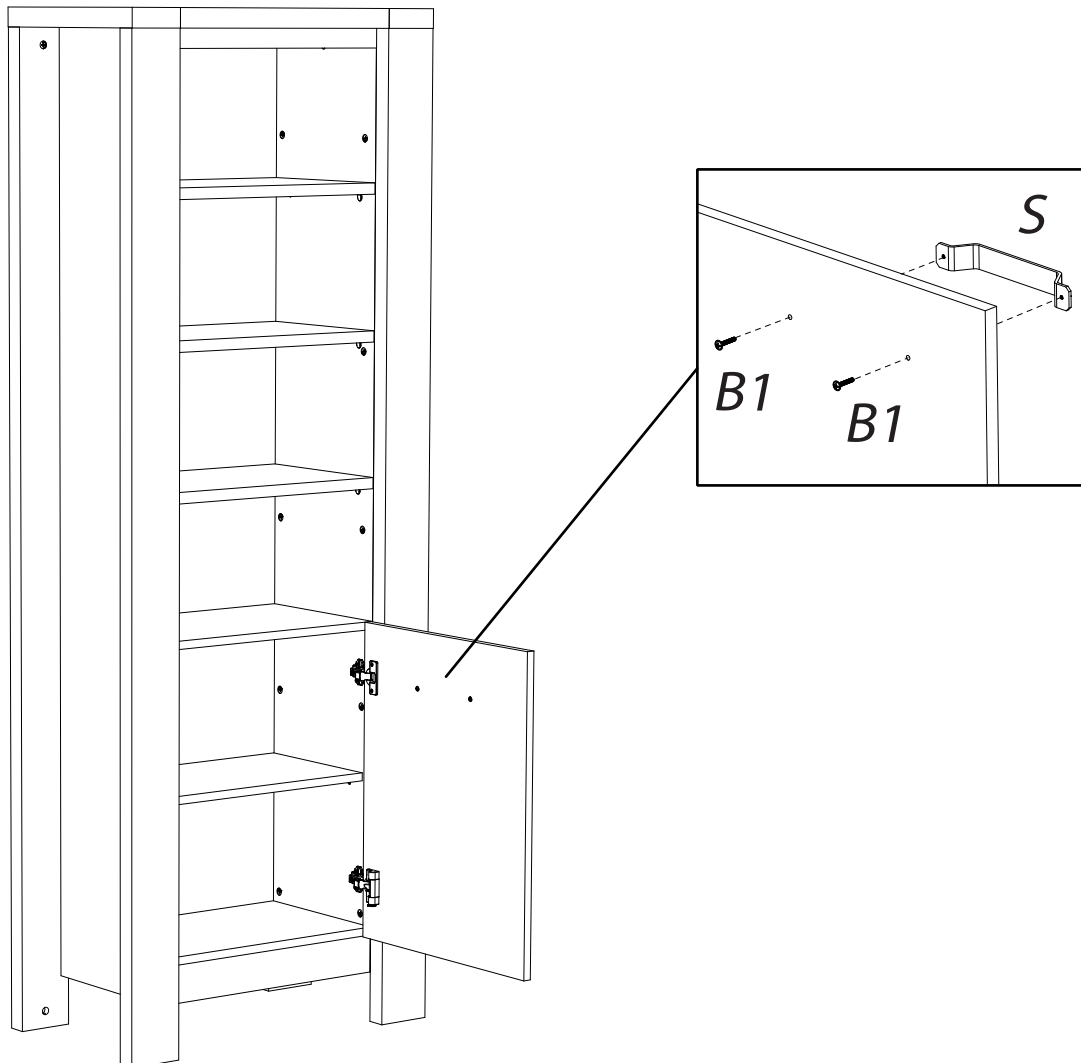
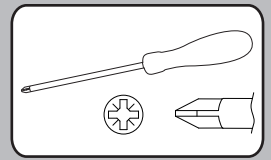
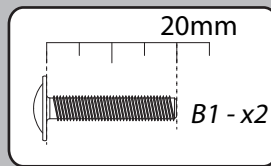
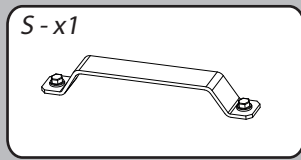

MALT 0123 :

Bibliothèque 1po composé de panneaux de particules revêtus papier Canyon Heritage Hickory et papier Gris Terra Mater à l'extérieur. L'intérieur est revêtus papier Canyon Heritage Hickory

A monter soi-même.

L.72 cm - H.200 cm - P.41 cm.

"Les meubles contenant des panneaux à base de bois (panneaux de particules, panneaux de fibres, contreplaqué...) peuvent émettre des substances polluantes dans l'air intérieur. Il est ainsi recommandé, après l'installation du meuble dans son logement, d'aérer fréquemment la pièce concernée pendant au moins quatre semaines afin de réduire son exposition aux polluants émis par le meuble."