



44 Avenue Paul Girard
10500 DIENVILLE
FRANCE
www.sciae.com

BAXTER

INDICE A - 19/07/2021

BAXTER 3117 TABLE PIED CENTRAL 180 N°50 Réf: 21SA2737
BAXTER 1117 TABLE PIED CENTRAL 180 N°50 Réf: 21SB2737

INDICE A - 19/07/2021

BAXTER 3117 TABLE PIED CENTRAL 220 N°55 Réf: 21SA2731
BAXTER 1117 TABLE PIED CENTRAL 220 N°55 Réf: 21SB2731

BAXTER 3117 EAN: 3102000112107

BAXTER 1117 EAN: 3102000112169

BAXTER 3117 EAN: 3102000112114

BAXTER 1117 EAN: 3102000112176

NOTICE DE MONTAGE
ASSEMBLING INSTRUCTIONS
MONTAGEANLEIUNG
MANUAL DE MONTAJE
MONTAGEVOORSCHRIFT
INSTRUÇÕES DE MONTAGEM
ISTRUZIONI DI MONTAGGIO
ИНСТРУКЦИЯ ПО СБОРКЕ
Naputci za montažu

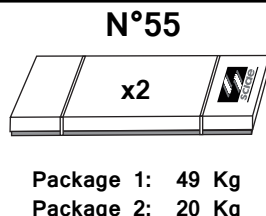
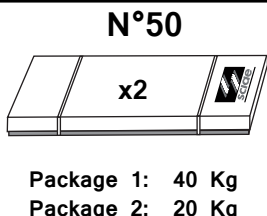
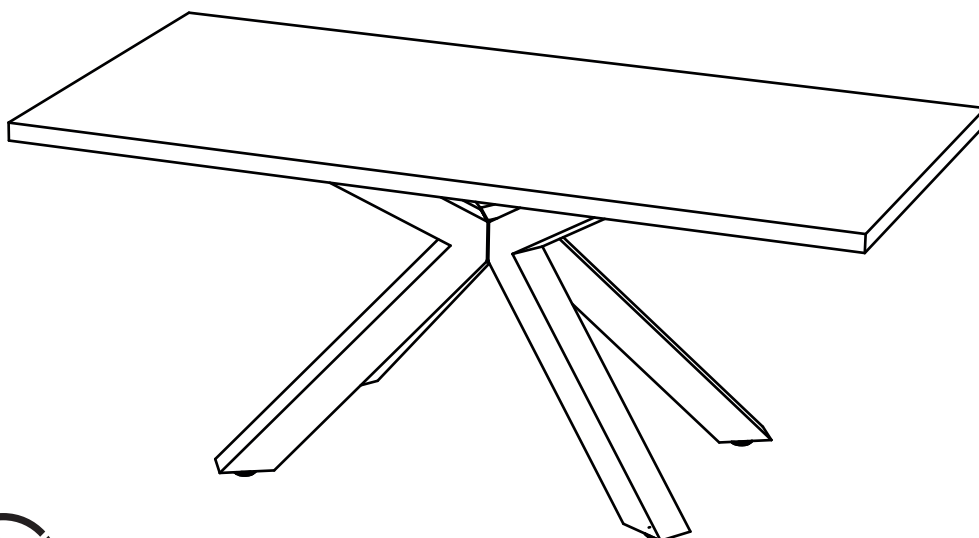

- F** POUR L'APRES-VENTE, RETOURNEZ AU MAGASIN AVEC CETTE NOTICE
- GB** FOR THE AFTER SALES, GO BACK TO THE SHOP WITH THIS ASSEMBLY INSTRUCTION
- D** WENDEN SIE SICH BITTE AN IHREN HANDLER UND GEBEN SIE IHM DIE KENNUMMER DES MOBELS UND DIE TEILNUMMER
- E** EN CASO DE SERVICIO POST-VENTA DEBEN DE VOLVER A LA TIENDA CON LAS INSTRUCCIONES DE MONTAJE
- NL** VOOR SERVICE NA VERKOOP, GA NAAR UW LEVERANCIER MET DEZE MONTAGE HANDLEIDING
- P** PARA O POS VENDA, VOLTE A LOJA COM ESTA FOLHA
- I** SERVIZIO POST VENDITA: E NECESSARIO PRESENTARSI SUL PUNTO VENDITA CON QUESTE ISTRUZIONI DI MONTAGGIO
- RU** ДЛЯ ПОСЛЕПРОДАЖНОГО ОБСЛУЖИВАНИЯ ПРОСЬБА ОБРАТИТЬСЯ В МАГАЗИН ПРЕДЪЯВИВ НАСТОЯЩУЮ ИНСТРУКЦИЮ ПО СБОРКЕ
- HR** U SLUČAJU REKLAMACIJE, VRATITE SE NA PRODAJNO MJESTO S OVIM UPUTAMA ZA MONTAŽU

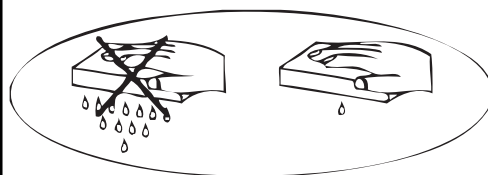



	+40°C +104°F	
	HYGROMETRIE HYGROMETRY 40%-65%	
	+15°C +59°F	

1 an
1 year

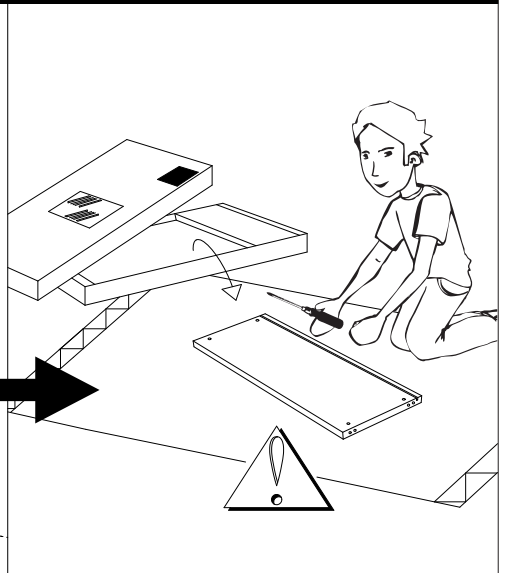
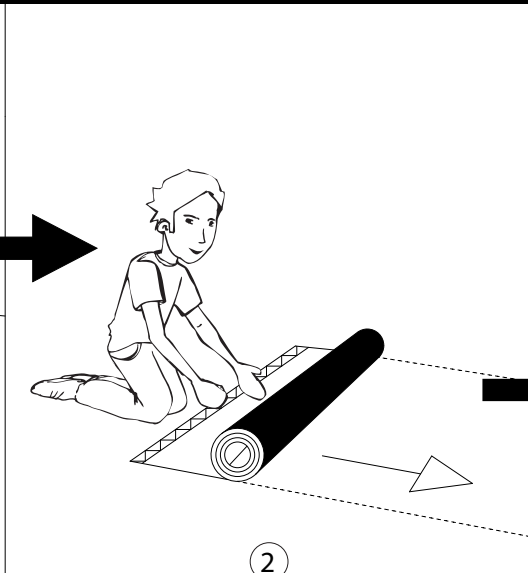
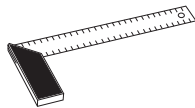
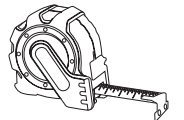
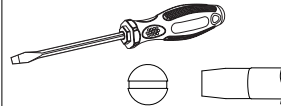
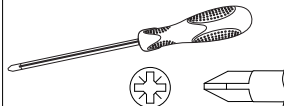
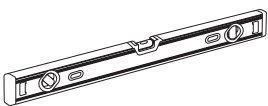
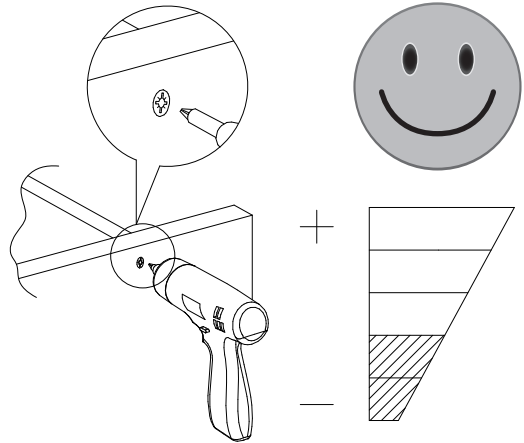
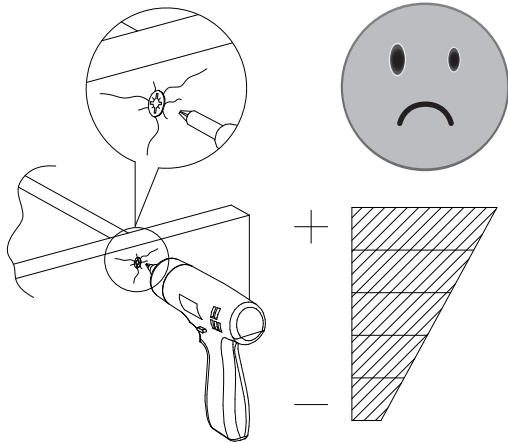
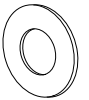
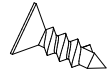
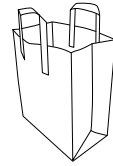
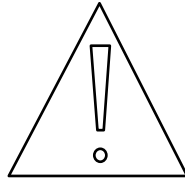

OK

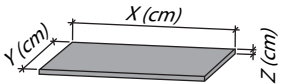
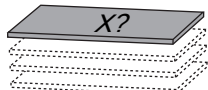
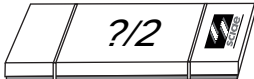

BAXTER TABLE PIED CENTRAL 180 N°50

DESIGNATION		N°		
Plateau	180 x 90 x 3.8	08		1
Pied métal central	117.8 x 71.5 x 69.6	80		2

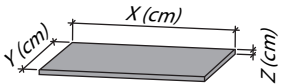
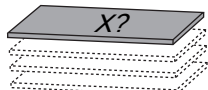
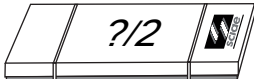
BAXTER TABLE PIED CENTRAL 220 N°55

DESIGNATION		N°		
Plateau	220 x 90 x 3.8	08		1
Pied métal central	117.8 x 71.5 x 69.6	80		2

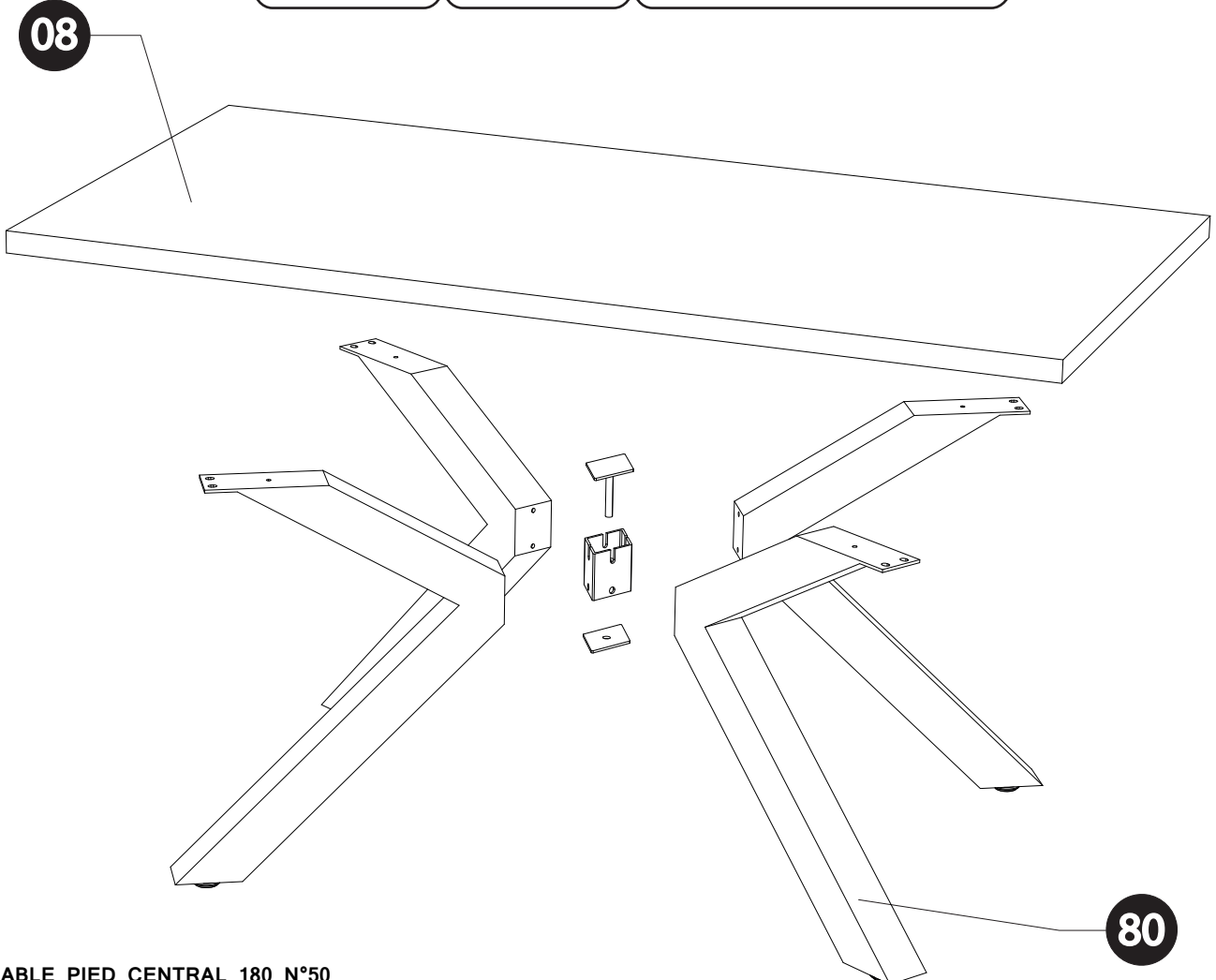
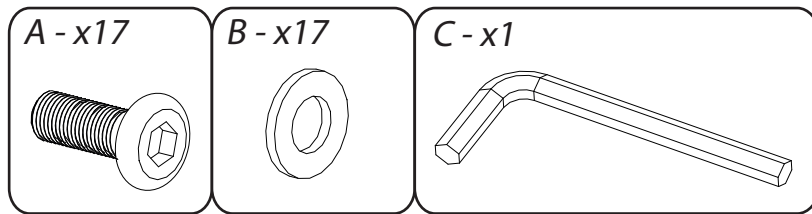

1

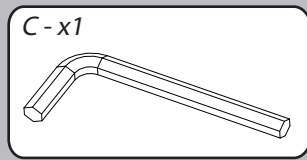
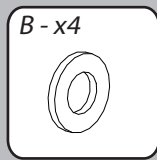
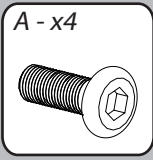

“VISSER A 50 % LES VIS”
“TIGHTEN THE SCREWS 50%”

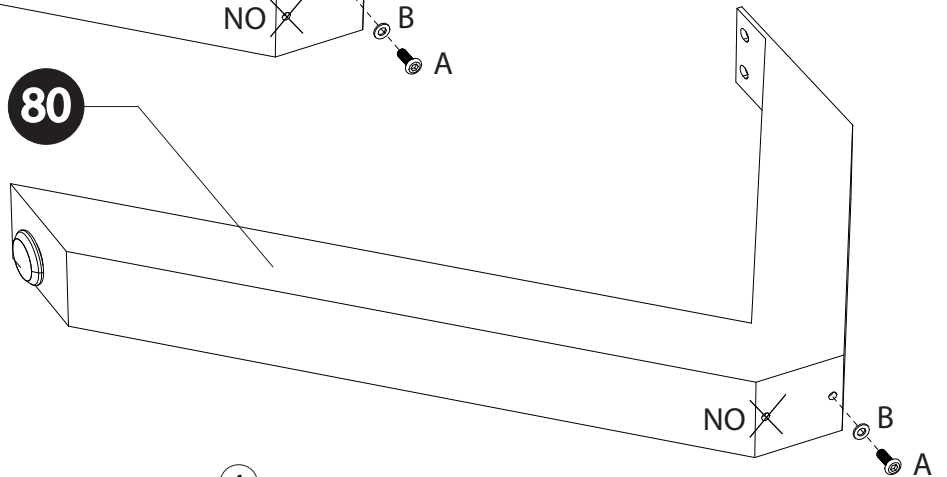
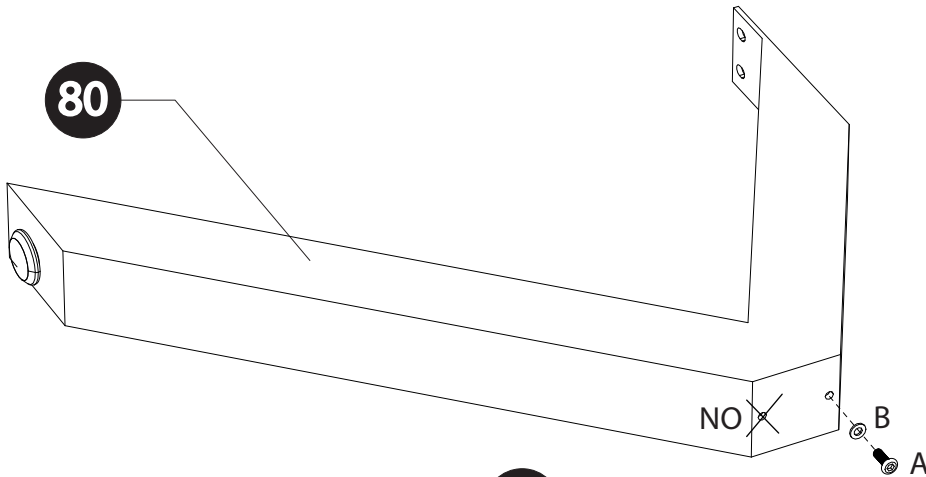
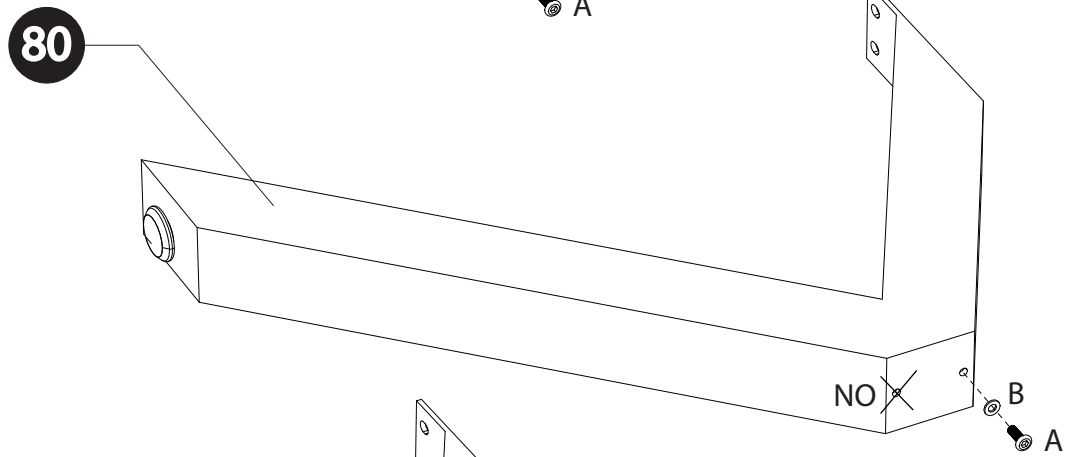
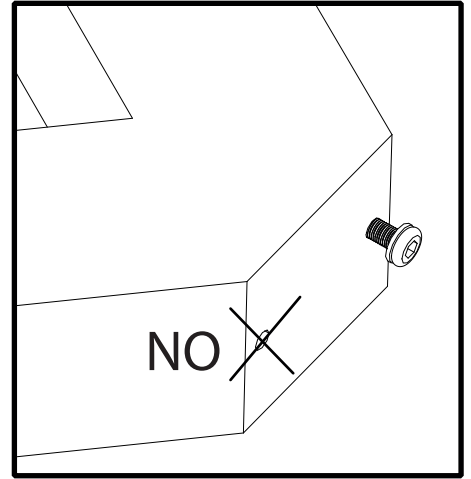
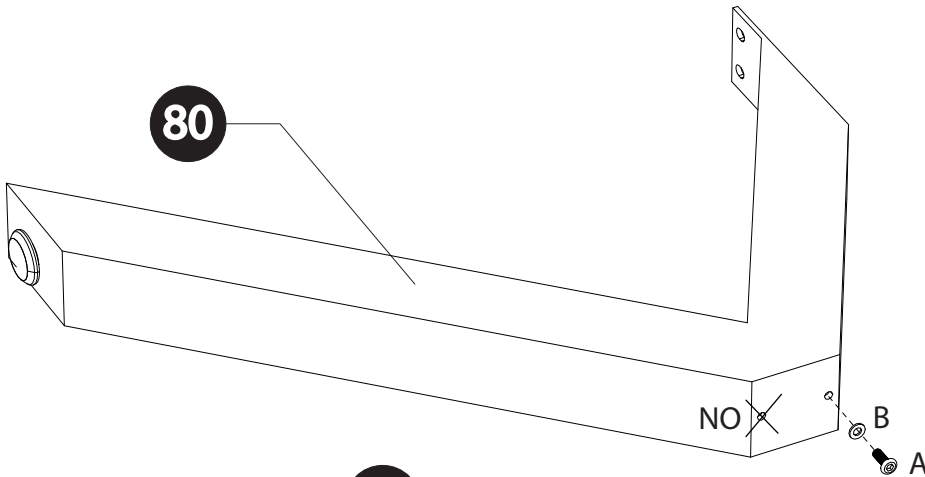

2

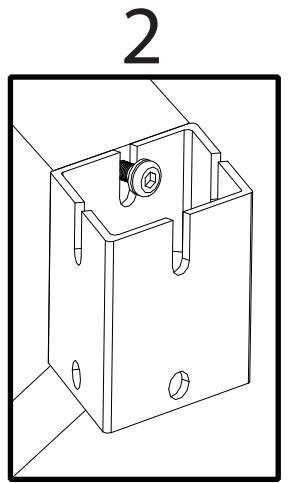
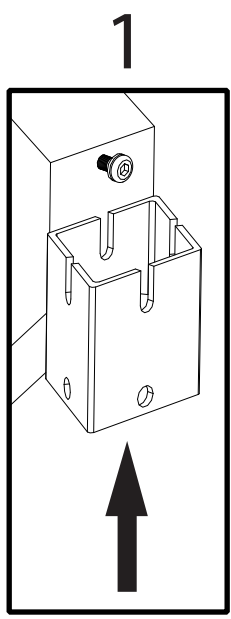
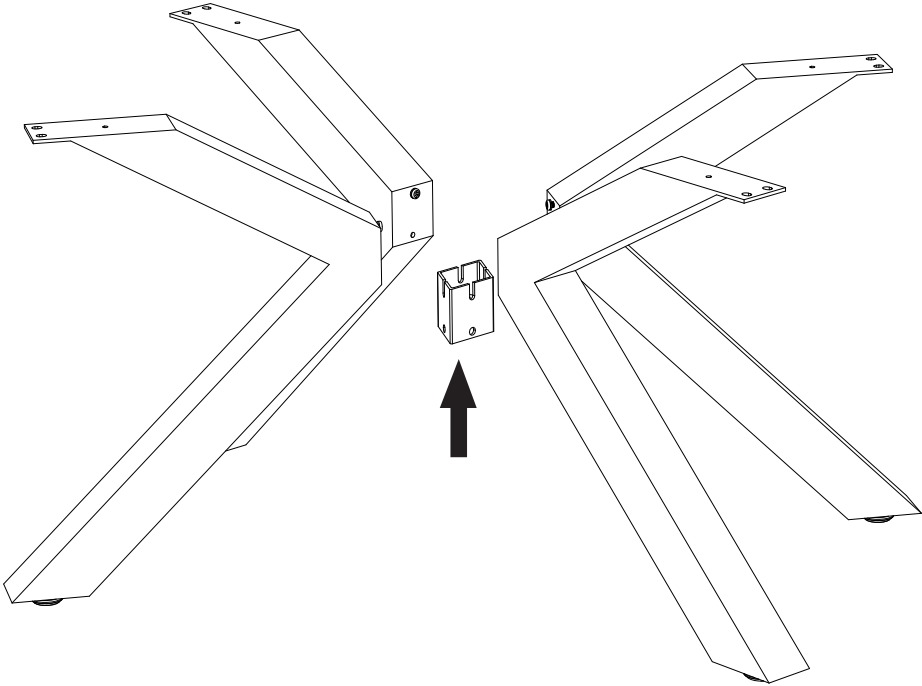
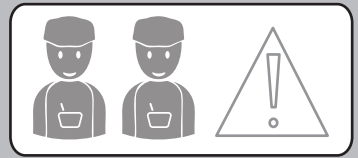
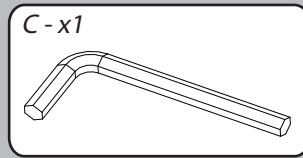
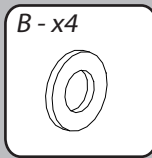
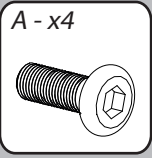

"VISSER A 70 % LES VIS"
"TIGHTEN THE SCREWS 70%"

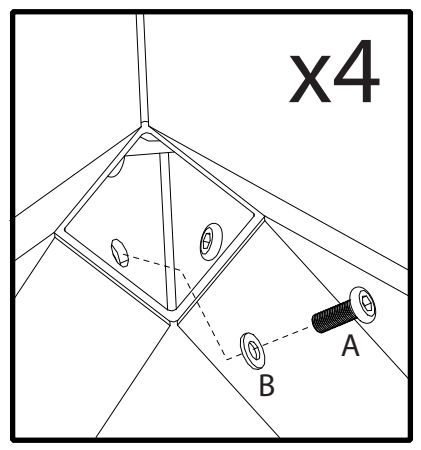
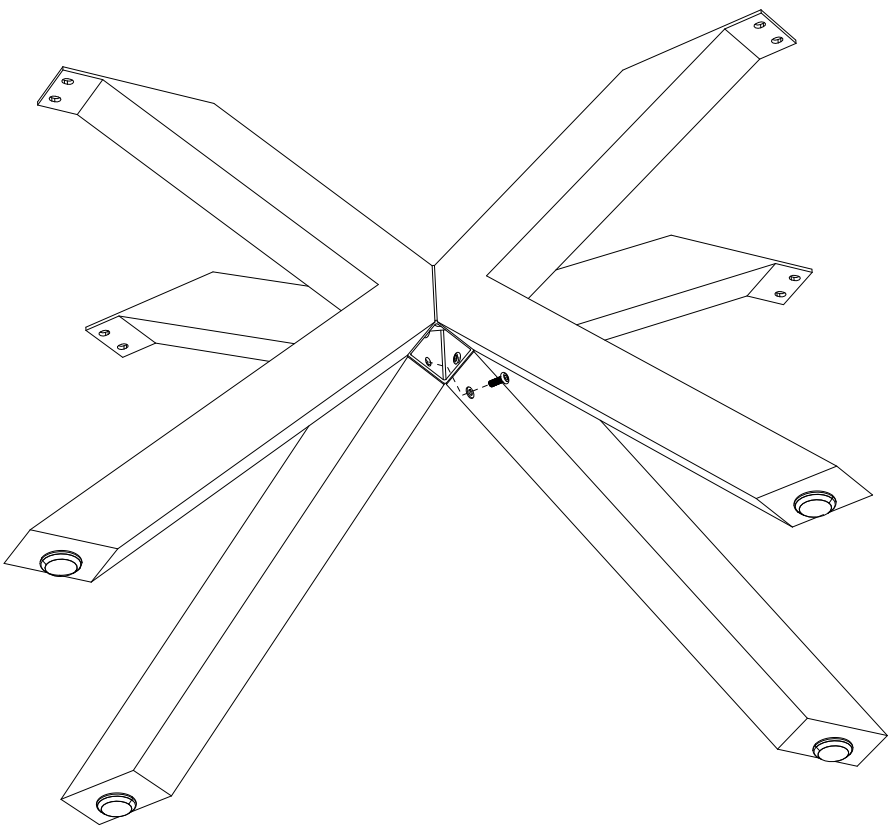

3

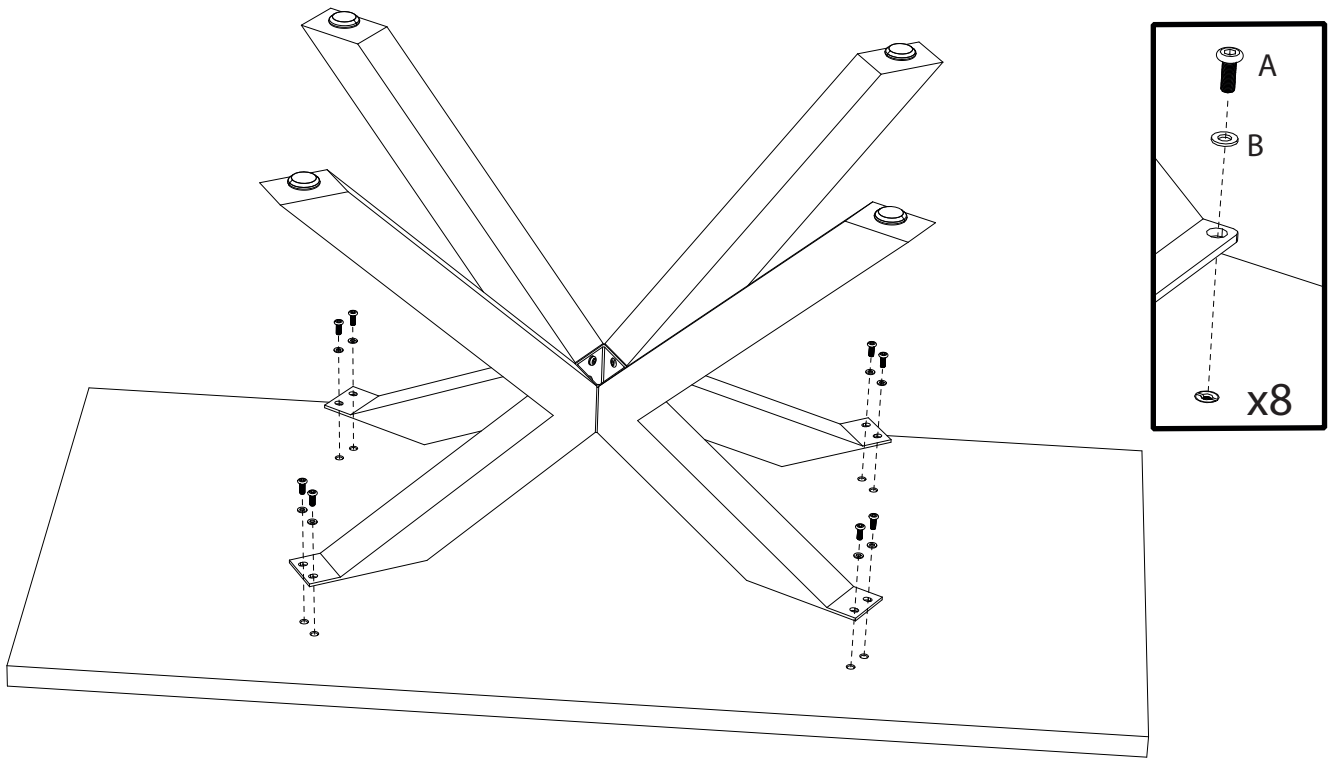
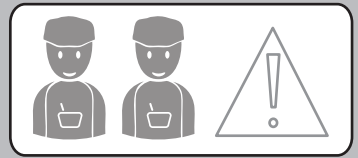
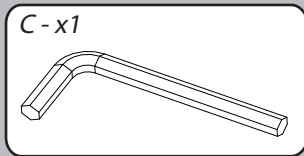
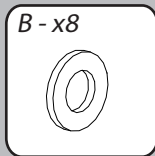
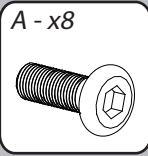

4

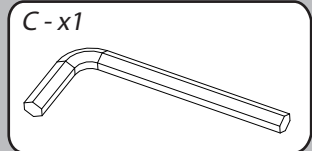

"VISSER A 100 % LES VIS"
"TIGHTEN THE SCREWS 100%"

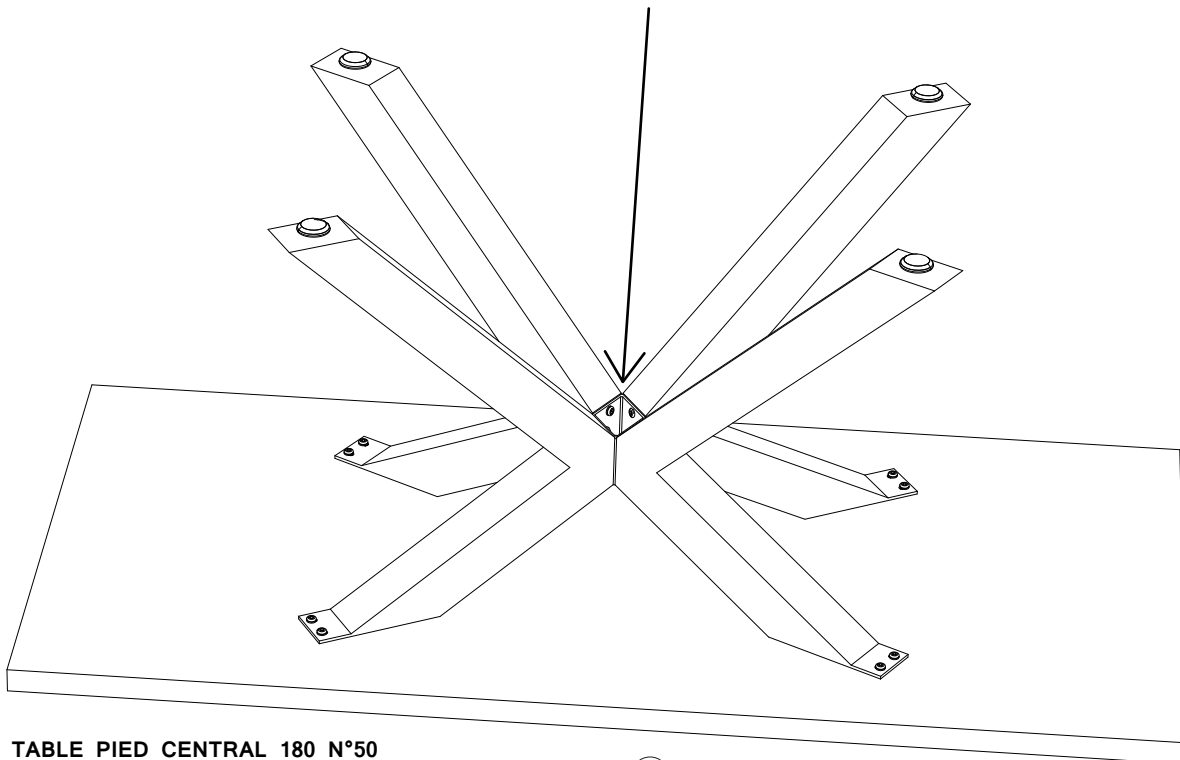

5

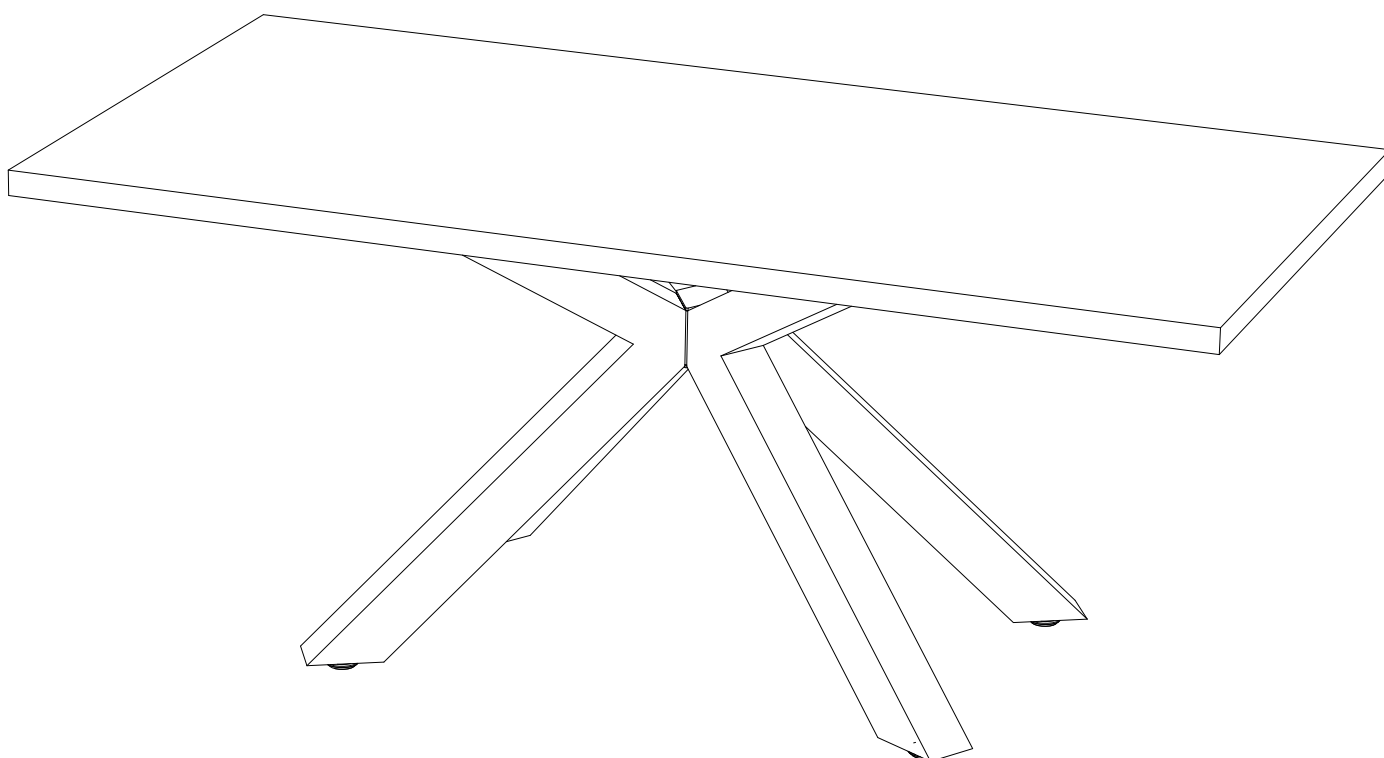
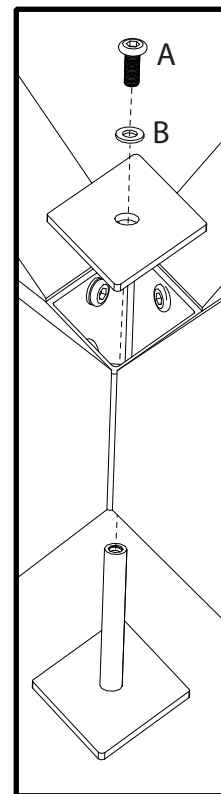
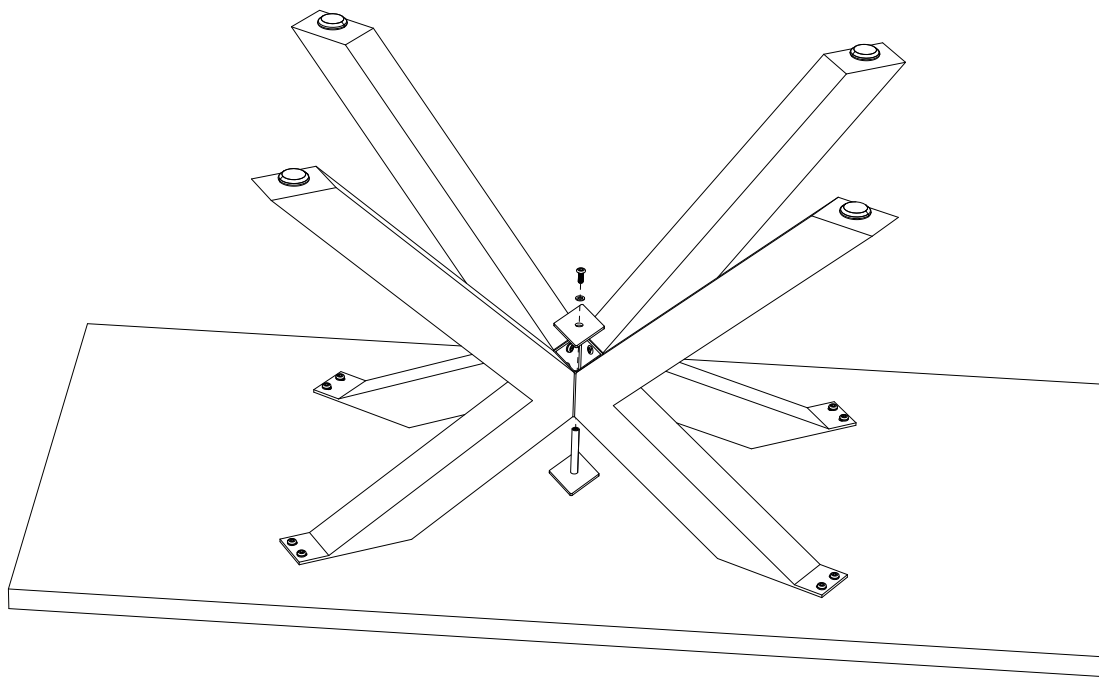
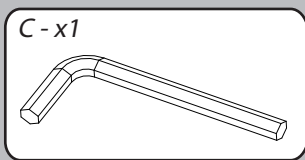
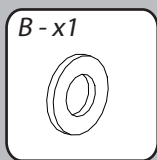
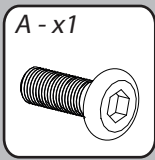

BAXTER 1117 / BAXTER 3117:

Table pied central composé de panneaux de particules revêtus papier Limerick Oak(1117) / Bonifacio Oak(3117).

Pied métal noir mat.

Table pied central 180 N°50 L.180 cm - H.76.5 cm - P.90 cm.

Table pied central 220 N°55 L.220 cm - H.76.5 cm - P.90 cm.

A monter soi-même.

FRANCAIS

Recommandations de démontage :

En cas de déménagement, il convient de procéder au démontage de votre meuble, en ôtant toute la visserie.

ENGLISH

Disassembly advices:

In case of moving, it is needed to dismantle the furniture removing the fittings.

DEUTSCH

Empfehlungen für die Demontage:

Bei Transport bitte alle Beschläge demontieren.

"Les meubles contenant des panneaux à base de bois (panneaux de particules, panneaux de fibres, contreplaqué...) peuvent émettre des substances polluantes dans l'air intérieur. Il est ainsi recommandé, après l'installation du meuble dans son logement, d'aérer fréquemment la pièce concernée pendant au moins quatre semaines afin de réduire son exposition aux polluants émis par le meuble."